GENEREX Comprehensive User Manuals

English

UPS WEB/SNMP MANAGER CS141

SENSORMANAGER & Accessories

BACS Battery Analyze & Care System

Copyright Statement for Intellectual Property and Confidential Information

The information contained in this manual is non-conditional and may be changed without due notice. Although Generex has attempted to provide accurate information within this document, Generex assumes no responsibility for the accuracy of this information.

Generex shall not be liable for any indirect, special, consequential, or accidental damage including, without limitations, lost profits or revenues, costs of replacement goods, loss or damage to data arising out of the use of this document.

Generex the manufacturer of the BACS products undertakes no obligations with this information. The products that are described in this brochure are given on the sole basis of information to its channel partners for them to have a better understanding of the Generex products.

GENEREX allows its channel partners to transfer information contained in this document to third persons, either staff within their own Company or their own customers, either electronically or mechanically, or by photocopies or similar means. GENEREX states that the content must not be altered or adapted in any way without written permission from GENEREX.

It is agreed that all rights, title and interest in the GENEREX's trademarks or trade names (whether or not registered) or goodwill from time to time of GENEREX or in any intellectual property right including without limitation any copyright, patents relating to the Products, shall remain the exclusive property of GENEREX.

GENEREX will undertake to deal promptly with any complaints about the content of this document. Comments or complaints about the document should be addressed to GENEREX Systems GmbH.

Copyright of the European Union is effective (Copyright EU).

Copyright (c) 1995-2021 GENEREX GmbH, Hamburg, Germany. All rights reserved.

Introduction

Thank you for trusting the CS141 Webmanager – the most powerful solution for critical resource management.

Since the CS141 was designed to be a full-fledged, standalone manager, its task is not limited to gathering and sharing information. It also accomplishes numerous tasks in measurement controlling devices dealing directly with critical resource management. Furthermore, the CS141 comes with a full-featured message management system. The CS141 cannot only answer requests coming from higher-level systems - it can also independently inform responsible employees in case of an emergency incident as well as initiating emergency measures based predetermined parameters:

The CS141 can automatically activate basic or advanced emergency systems, shut down servers and workstations. Even automatic restart at predetermined conditions is configurable. In addition to standard technologies such as SNMP and Modbus, the CS141 relies on using the powerful RCCMD software solution. By doing so, even the emergency behavior of complex, fully virtualized server landscapes are realizable.

Thanks to RFC1628 the CS141 provides more flexibility than ever

This feature provides new possibilities to integrate third-party UPS systems. Thanks to the new RFC1628 compliant UPS interface, administrators can use the CS141 to poll any SNMP card that supports these standards. Simply use the SNMP-card installed inside your UPS and display the current status natively inside CS141.

This will allow administrators to use the powerful products made by GENEREX in combination of UPS-Systems that are normally not compatible.

Note

Due to the fact the CS141 Web Manager can act as a stand-alone system for managing, it can be used flexibly in many areas, even outside the functionality described in this guide. This manual therefore describes the fundamentally implemented functionality according to UPS systems. However, the enormous flexibility and the possibility of communicating with higher and lower-level systems using standardized interfaces allows the adaption to very different possibilities to use.

About this manual

This manual is more than just a small leaflet – it is written to explain and show all functions of a CS141 – you will notice, this device is very powerful and flexible, you are not limited to use this device as a UPS monitoring card. You can monitor, control, switch or communicate to any parent or child system inside complex IT systems.

This manual is written to show you what you can do with a CS141 and explains how to configure the device – in some cases you will not find some menus described in this manual. Here are some possible reasons:

- The function is not enabled, you need a new firmware.
- Additional devices are needed
- Your CS141 model does not support the function you are looking for
- During the ongoing development progress, sometimes functions will be automated or moved to other menus in order to increase the usability.

This manual is divided into three parts:

- CS141
- BACS

If this is your first CS141, this manual will guide you step by step through all menus and explain nearly everything you need to ensure emergency power and use the notification functions.

What you need to know:

Each model of the CS141 family can handle RCCMD – the CS141 is the RCCMD sender, and the RCCMD software client is the according receiver.

BACS more than “just an option” – it is a powerful battery management solution that may operate as a standalone system. If you are interested in battery management, this chapter is very interesting – but be careful!

Working with batteries inside a UPS system is for experienced or special trained technical who are familiar with all symbols and functions as well as how batteries work. With BACS, you can manage your batteries and optimize your entire UPS solution as well as increasing the battery performance and life time.

Table of Contents

Part 1: CS141

Introduction

- [Model Overview](#)
- [Delivery notes](#)
- [Function overview CS141](#)
- [Hardware Layout Appendix](#)
- [Interface Assignment](#)
- [External D-SUB 9-pin male](#)
- [Network integration of the CS141](#)

Preperations

- [Preparation at the CS41](#)
- [Preparing the Workstation](#)
- [Using DHCP](#)
- [Finding CS141 in networks / MAC address](#)
- [Netfinder](#)

Basic SettingsConfiguration

- [Installation examples](#)
- [Required Ports](#)
- [Default Passwords](#)
- [Menu structure of the CS141](#)
- [The Config Information Center](#)
- [Enhanced and optional menus](#)
- [Differences in operation modes](#)
- [Basic login passwords](#)
- [Setup Wizard](#)
- [IP-address settings and hostname](#)
- [Location and contact settings](#)
- [Provided services](#)
- [Date and time](#)
- [Tutorial: How to set up a custom time server](#)
- [User management](#)
- [RADIUS Server](#)
- [RADIUS with Microsoft NPS / Cisco ISE](#)
- [802.1X RADIUS Support](#)
- [System overview](#)
- [Switching to operational mode](#)

Mail Settings

- [Email settings](#)
- [Advanced Mail Options](#)
- [Test Mail Settings](#)
- [The most common error message](#)
- [Email traps](#)
- [Tutorial: Email traps](#)
- [How many mail addresses are possible with Email traps?](#)

Modbus

- [Modbus as single-master-protcol](#)
- [Differences between CS141 Modbus and Professional](#)
- [Pinout of the modbus connection](#)
- [The modbus termination PIN](#)
- [Modbus over RS232/RS485 and Modbus over IP](#)
- [Modbus functions codes](#)
- [Modbus error code table](#)
- [Configuration of modbus](#)
- [Tutorial: Working with MODBUS addresses](#)

SNMP

[What is SNMP](#)
[Setting up SNMP V2](#)
[Setting up trap receiver](#)
[Testing Trap receiver with SNMP v2](#)
[Setting up SNMP v3](#)
[Using Trap settings with SNMP v3](#)
[Restarting the SNMP Agent](#)

Bacnet

[What is BACnet?](#)
[Using BACnet with the CS141](#)

Remote Syslog

[What is remote syslog](#)
[Setting up remote syslog](#)
[Setting up TLS certificates for remote Syslog](#)
[Checklist: remote Syslog problems](#)
[About the use of SYSLOG](#)

UPS Configuration

[General COM Port Settings](#)
[The pipe through function](#)
[Configuration of a UPS](#)
[Battery Health Level \(%\) feature](#)
[RFC 1628 UPS Interface](#)
[UPS monitoring screen](#)
[UPS functions](#)
[UPS event handling](#)
[The intention of a job](#)
[Managing jobs](#)
[Available jobs](#)
[Tutorial: The Job "Remote Command"](#)
[Tutorial: The WOL packet](#)
[UPS Shutdown definition](#)
[How to configure a job](#)
[Time management of jobs](#)
[Adding jobs to several events](#)
[Delete jobs](#)
[Counter Events](#)

Custom Thresholds

[What are Custom Thresholds](#)
[Difference Warning/Alarm Levels](#)
[Example scenario: Custom Thresholds](#)
[Exemplary excerpt: Custom Thresholds](#)
[Tutorial: Custom thresholds](#)

CS141 RCCMD Server

[What is RCCMD](#)
[Available RCCMD Commands](#)
[Configuration of RCCMD](#)
[Setting up the IP address for RCCMD](#)
[Timing for RCCMD jobs](#)
[Variables for RCCMD traps](#)

Sensors and additional devices

[SM_T_H_COM Standalone Sensor](#)
[General COM Port Settings](#)
[Setting up a sensor](#)
[Sensor monitoring screen](#)
[Event handling for sensors](#)
[Sensor related system events](#)
[Setting up a job for sensor events](#)

[SENSORMANAGER](#)

[SENSORMANAGER: - Sensor matrix](#)
[SENSORMANAGER - Adding analog sensors](#)
[SENSORMANAGER - Sensor event vs matrix event](#)
[SENSORMANAGER - Setting up the logical connection](#)
[SENSORMANAGER - Digital inputs](#)
[SENSORMANAGER - Linking digital inputs and analog sensors](#)
[SENSORMANAGER - Switching an output](#)
[SENSORMANAGER - Tutorial: Example scenario: aquarium](#)
[SENSORMANAGER - Possibilities of the sensor matrix](#)

[Alarm device / buzzer](#)
[GSM modem](#)
[CON_AUX4 and CON_R_AUX4](#)

Scheduler

[How the scheduler works](#)
[Setting up scheduled Jobs](#)

Web Server

[Safety instructions](#)
[HTTP settings](#)
[PORT settings](#)
[Force HTTPS](#)
[HTTP refresh time](#)
[Simple monitor](#)
[Tutorial: Creating a PEM-File](#)

Diagnostic:

Logfiles

[Event Log](#)
[Data log](#)
[Data log Diagram](#)
[UPS Alert history](#)

Tools

[Reboot](#)
[Tracer](#)
[Network Scan](#)
[Privacy Notice: Network Scans](#)
[Evaluation of data](#)
[Deleting data](#)
[Tutorial: Complete data deletion](#)
[Changing Logo](#)

Data backup and updates

[Creating backups](#)
[Restore configuration from a backup](#)
[Restore network data](#)
[Performing a firmware update](#)
[Changing the OEM firmware](#)

If nothing works ...

[Password lost / forgotten](#)
[Rebooting without login](#)
[Performing a firmware update directly](#)
[The rescue mode on the CS141](#)
[Rescue mode on the CS141 Mini](#)

Part 2: BACS

What is BACS?

- [What is BACS?](#)
- [What is the advantage of BACS](#)
- [EQUALIZATION: maintain individual charging / discharging](#)
- [Upgrade CS141 to a BACS system](#)

BACS Installation Guide

Please read carefully before starting with working on batteries:

- [How to use the BACS manual](#)
- [Fundamentals when working on batteries](#)

Mandatory additional components

- [BACS C module](#)
- [BACS measuring cable](#)
- [BACS bus cable](#)

Installation examples

- [BACS installation examples](#)
- [BACS Bus topology](#)
- [BACS Splitting box](#)
- [Technical data of the BACS Splitting Box](#)
- [BACS installation with two webmanager](#)

Battery preparation

- [Battery preparation](#)
- [Things to be followed during initial installation](#)
- [Connection BC5 measuring cables](#)
- [Connecting BC4B measuring cables](#)
- [Mounting BACS modules](#)
- [Maintenance: Replacing a BACS module / Replacing the internal temperature sensor](#)

Initial BACS configuration

- [General battery data](#)
- [Number of battery strings](#)
- [Two Jars / Cells per module: Differences when using NiCd](#)
- [Basic setting of a BACS module](#)
- [Offset values](#)
- [Impedance measuring intervals](#)
- [External current sensor](#)
- [Premium feature: Ampere Multiplier](#)
- [Discharge detection: Thresholds for current sensor](#)

Initial BACS module setup

- [Addressing the BACS modules](#)
- [BACS Programmer restart conditions](#)
- [Defining an address range for module reset](#)
- [General Module setup](#)
- [Adress range setup conditions](#)
- [BACS Programmer single mode](#)
- [BACS Error: HW Revision / Calibration error](#)

BACS Programmer software tool

- [How to connenct a computer](#)
- [Preparing BACS installation](#)
- [Operating modes: Automatic mode](#)
- [Operating mode: Manual mode](#)
- [Line check](#)
- [Receive Line Check](#)

GX_R_AUX

- [How it works](#)
- [Connectors](#)
- [Addressing the GX R AUX](#)
- [Configuration of the GX R AUX](#)

[GX_R_AUX as battery breaker](#)
[Normally Open / Normally Closed contacts](#)
[Defining a job to a BACS event](#)
[Communicate with third party devices via Outputs / Inputs](#)

BACS functions

[BACS Buzzer](#)
[BACS Relay](#)
[Discharge Counter Reset](#)

BACS alarm threshold

[Overvoltage](#)
[Deep discharge](#)
[Threshold definition](#)
[Impedance](#)
[Voltage](#)
[Alarm delay](#)
[Temperature](#)

Battery strings and thermal runaway

[Define BACS battery strings](#)
[BACS strings vs battery breaker](#)
[What is a thermal runaway?](#)
[Mandatory preconditions for BACS thermal runaway functions](#)
[Max. module temperature difference](#)
[Max current per string](#)
[Above conditions are true since](#)

Log files

[BACS Log files](#)

Initial Start up: Pause Equalizing on Schedule

[What is an unformed battery?](#)
[Why pause Equalizing during initial start up?](#)
[How to use a scheduled equalization pause](#)
[Equalization Pause Example 1](#)
[Equalization Pause Example 2](#)
[Equalization Pause Example 3](#)
[Tutorial: BACS Equalization paused by system](#)
[BACS Trouble Shooting List](#)

Appendix

[CS141 / BACS Hardening Guide](#)
[Hardware Layout CS141](#)
[Differences to the CS121](#)
[Interface Description](#)
[Pin COM2 Mini-DIN 8 pol](#)

Modbus addresses

[Section OEM: ABB/NEWAVE UPS Type Concept Power](#)
[Section OEM: MASTERGUARD](#)
[Section OEM: Centièl](#)
[Section OEM: RITTAL PMC Extension](#)
[Section OEM: Netminder for all LT and MD types](#)
[Section OEM: Netminder EON](#)
[Section OEM: Netminder for all other types](#)
[Section OEM : AEG Protect 3. M 2.0](#)
[Section OEM: AEG Protect 3.31, 5.31, 8.31](#)
[Section OEM: AEG Protect 2.33, 3.33, 4.33, 5.33, 8.33, blue](#)
[Section OEM: POWERTRONIX](#)
[Section OEM: Socomec UPS](#)
[Section MHD Modular / Multimatic Modular / AEG Protect 1. Modular, ENIGMA](#)
[Section Borri 4000 Std. Panel / E-Tec 310 to 380 \(m\) / SALICRU SLC NX/DL/CUBE](#)
[Section Inform UPS / Pyramid DSP/Online DSP](#)
[Section Transfer Switches \(All Transfer Switch vendors, except PILLER, STS TUMEL\)](#)
[Section STS TUMEL Transfer Switch](#)
[Section OEM TRIMOD](#)
[Section: EverExceed Inverter](#)

Parameters for UPSMAN Software and BACS

[UPSMAN Status Bytes - Standard Device Status Bits](#)
[BACS Parameters](#)

Last, but not least:

[Copyright and licenses](#)

Model overview

Device	Function	Changes according to the hardware revision HW161	Remarks
CS141L	SNMP-Adapter	Gigabit-LAN, Memory Upgrade, Increased processor power	External Adapter
CS141SC	SNMP-Adapter	Gigabit-LAN, Memory Upgrade, Increased processor power	Slot Card Adapter for UPS slot usage.t
CS141LM	SNMP-Adapter	Gigabit-LAN, Memory Upgrade, Increased processor power	External Adapter with MODBUS Modbus interface (RS485)
CS141SCM	SNMP-Adapter	Gigabit-LAN, Memory Upgrade, Increased processor power	Slot Adapter with MODBUS interface (RS485)
CS141BSC	SNMP-Adapter	Gigabit-LAN, Memory Upgrade, Increased processor power	Slot Adapter BUDGET-Model (no COM / AUX Ports), only software based features available.
CS141 BL	SNMP-Adapter	Gigabit-LAN, Memory Upgrade, Increased processor power The CS141 BL model was discontinued in July 2022, existing devices will continue to receive full product and update support..	Budget-Version, no COM/AUX Ports installed, only software based features available.
CS141R_2	SNMP-Adapter	Gigabit-LAN, Memory Upgrade, Increased processor power. The MINI-Din connector has been replaced with a modern RJ12 connector to make COM 2 and COM 3 available.	Slot Adapter for PILLER/CTA/RIELLO/AROS UPS Italian
CS141MINI	SNMP-Adapter	Gigabit-LAN, Speicherupgrade, Mehr Rechenleistung. The MINI-Din connector has been replaced with a modern RJ12 connector to make COM 2 and COM 3 available.	Slot Adapter for UPS providing a MINI Slot

Available devices based on the CS141 product family

Device	Function	Remarks
BACSKIT_B4	Battery Managemnt	External Webmanager
BACSKIT_BSC4	Battery Management	Slot Card Version with external Converter

Device	HW141	HW161	Additional Features	Supported UPS Systems
CS141L	BOTH		Additional Mini DIN 8 COM Port for RS232, Sensors and sensormanager. AUX Port for Digital inputs and outputs. RAS Management optional.	Supports more than 1400 UPS models and over 80 different manufacturers..
CS141SC	BOTH		Additional Mini DIN 8 COM Port for RS232, Sensors and sensormanager. AUX Port for Digital inputs and outputs. RAS Management optional..	All UPS providing a Standard Slot
CS141LM	BOTH		RS485 Modbus interface with integrated jumper to define the last device in a row.AUX Port for digital inputs and outputs.	Supports more than 1400 UPS models and over 80 different manufacturers.
CS141SCM	BOTH		RS485 Modbus interface with integrated jumper to define the last device in a row.AUX Port for digital inputs and outputs.	All UPS providing a Standard Slot
CS141BSC	BOTH		Special budget version of the CS141 without additional COM ports - no further external sensors and actuators possible.	All UPS providing a Standard Slot
CS141 BL	BOTH		Special budget version of the CS141 without additional COM ports and a reduced capacity (max. 6 KV) - no further external sensors and actuators possible Note: The CS141 BL was discontinued in July 2022, existing devices will continue to receive full product and update support.	Supports more than 1400 UPS models and over 80 different manufacturers.
CS141R_2	Differences as described at Additional Features		HW141: Additional Mini DIN 8 COM Port for RS232 devices HW161: The Mini-DIN-8 port was replaced by an RJ12 connection, the HW161 platform also offers full support of COM 2 and COM 3 via a special adapter plug.	Riello and Aros UPS providing a Netman Slot
CS141MINI	Differences as described at Additional features		HW141: Additional Mini DIN 8 COM Port for RS232 devices HW161: The Mini-DIN-8 port was replaced by an RJ12 connection, the HW161 platform also offers full support of COM 2 and COM 3 via a special adapter plug.	UPS providing a MINI Slot (Soltec, Voltronic, u.a)

All units of the CS141 product family provide an internal database to query the UPS models of a manufacturer or OEM partner individually according to the respective protocol descriptions. The measured data are evaluated and clearly presented in a corresponding monitoring screen in realtime, and can be queried by standardized network protocols of building management systems (Modbus IP, BACnet, SNMP, Syslog, etc. ...). The available measurement results and functions depend on the UPS model selected. In addition, an independent monitoring system is available.

In addition, all units of the CS141 product family offer comprehensive event management, the scope of which depends on the communication options of the connected UPS: Based on the status of a UPS, timed system events can be triggered individually. All units can also be individually configured for all events and job executions via scheduler, for example

- Battery tests,
- calibration
- UPS shutdown/restore.

This provides the user with a wide range of network management features for comprehensive and holistic resource management.

Scope of Delivery

Der Lieferumfang des CS141-Adapters beinhaltet standardmäßig eine Netzwerk-Adapter-Einheit mit ergänzender Soft- und Hardware. (Bitte beachten Sie, dass in den Budget-Ausführungen nicht alle Funktionen enthalten sind).

Note:

Keep in mind, the budget version do not provide hardware interfaces – some functions are not available.

Produkt	Im Lieferumfang enthalten					
	External Power Source	User manual on CD	Mini-DIN-8 interface (MODBUS)	RS-485 Via COM2	Rescue Jumper CS141	Rescue Jumper CS141HW161
CS141L	X	X	X		X	X
CS141SC		X	X		X	X
CS141LM	X	X		X	X	X
CS141SCM		X		X	X	X
CS141BSC		X			X	X
CS141 BL	This model is no longer available. Existing devices will continue to receive full support and regular firmware updates.					
CS141R_2		X	X			X
CS141MINI		X	X			X

FAQ'S: Changes coming with hardware revision HW161 2022

Will there be a change in firmware supply?

No, both hardware versions will be equally supplied with firmware - the CS141 and the CS141HW161 will offer the same features.

What makes the CS141HW161 "different" or in other words: why is it still called CS141?

Well, it is still the CS141 WEBMANAGER with all its documents, release tests, etc. Only the internal hardware platform has been slightly adapted to meet the requirements of a modern IT infrastructure and to provide more than enough reserves for future standards. There was no need to introduce a new product....

With the change to the CS141 HW161 hardware, there have been a few small changes in operation, mainly affecting the slot cards.

1. New Function: Slot cards now provide an reachable reset button

Until now, the CS141 slot card had to be removed from the UPS for a "hard reset". Since the card is a hot-plug system, this is not a problem; the installation slot of a UPS is usually designed for this. The problem was rather that technicians did not always have easy access to the slot screws.

With the HW161, there is now a handsome reset button so that the slot card no longer has to be removed for a restart.

It will not restore factory default settings, but just force a cold boot on button-press.

2. Gigabit LAN

A lot has happened in the hardware sector since the CS141 was launched in 2016. One of the biggest changes is the conversion of networks to native Gigabit LAN.

The CS141HW161 therefore uses a backward-compatible Gigabit LAN to ensure maximum compatibility for network structures.

3. CS141 MINI vs HW161MINI

This devices encountered were a few major changes and updates. The CS141MINI has been fundamentally revised as part of the hardware revision - and has also learned many new tricks and features. The CS141HW161 MINI is the smallest, fully featured battery management system on the market:

- New: No more tiny DIP-Switches

The CS141HW161 MINI now uses a slide switch instead, like all units in the CS141 product family.

- New: The Rescue-Jumper i

The CS141HW161 MINI uses a scaled-down version of the rescue jumper familiar from all units in the CS141 product family.

- New – The handsome Reset-Knopf for easy reset

- Like all slot cards, the CS141 HW161 MINI has been given a reset button with which it can be conveniently restarted without having to remove the unit.

- New: We replaced the Mini-DIN – interface, and use an RJ12 – interface instead.

Instead of the hard-wired MINI-Din connector, the CS141HW161MINI uses a special adapter plug that provides both a MINI-DIN connector and an RJ-12 connector. Due to this fact, it was possible for the CS141HW161 MINI to change some core functions:.

The CS141HW161MINI can now be used as a full-fledged BACS Webmanager in addition to all already known devices in conjunction with a BACS Bus Converter, making it the smallest WEBMANAGER on the market with the greatest range of functions ever available!

Ah, OK... but can I still prefer to get the "old one"?

Let's put it this way: Of course, you may ask specifically because you have concerns about the use of new hardware and its compatibility, but the CS141 with the HW141 is no longer being produced. We always try to keep a few selected units in stock in order to be able to deal with individual requests if necessary. However, we cannot guarantee whether and to what extent HW141 units are in stock.

Function overview CS141

In SNMP mode, the CS141 adapter works with a preinstalled Simple Network Management Protocol (SNMP) software agent.

This agent exchanges status data with the UPS via so-called "get / set" commands and forwards them in the form of "trap messages" to predetermined recipients. These "trap messages" allow to alert necessary persons during or before critical situations happen within the UPS. Typical information can be switching to battery power or the end of a power failure.

In addition, the SNMP adapter can send RCCMD signals (Remote Control Commands):

On clients with the RCCMD software installed, freely configurable functions can be triggered – the functionality range allow nearly everything. Administrators can run a simple system shutdown as well as a highly complex shutdown and restart routine. In addition, the web interface is also a control of the UPS possible.

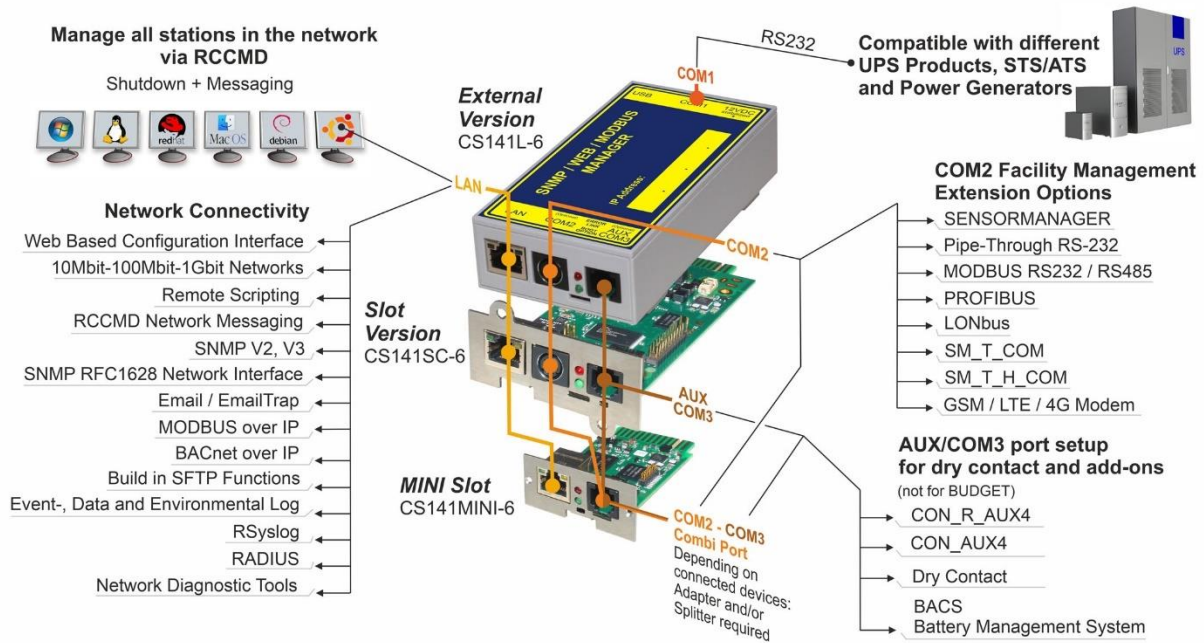

CS141 – Scope of functions

SNMP adapter

The SNMP adapter takes up little space due to its compact dimensions. The adapter has a size of 69x126 mm. (External SNMP adapter.) - or the adapter can be integrated into an expansion slot of the UPS (depending on the UPS model).

Premium function: the SNMP Traps

The basic task of the adapter is to communicate alarm states of the UPS to an according monitoring station (traps) or to provide UPS data if monitoring stations poll. With this function, e.g. the power supply and battery status of a UPS are monitored by an SNMP management station.

Additionally, the CS141 provides functions for simulating and testing trap messages during configuration procedure.

Remote Control:

Due to the fact the CS141 is capable to configure it is possible to trigger different remote-controlled actions. Administrators can perform battery tests, bypass the UPS batteries or configure UPS behavior

Note:

Depending on the UPS you are using, provided remote control functions may differ.

Compatibility according to third party network management systems

The SNMP adapter is compatible with all common network management systems. All SNMP systems providing the compilation of a MIB - or already contain the Management Information Base (MIB) / Request for Comment 1628 (RFC) for UPS systems - can be operated with CS141.

Full RCCMD support:

Due to the fact the CS141 is a full manager and not just an SNMP-Card to collect and provide data, the entire network shutdown routine can be configured to react as fast as possible:

Thanks to integrated RCCMD support, the CS141 offers a flexible and fast way to operate even the most complex shutdown solutions. By the usage of standardized network technologies and protocols, the RCCMD server transfers control commands that are executed by the clients in real time.

RS-232 / pipe-through:

In some cases, different networks without any connections have to be configured to use the same UPS. With the new pipe-through capability administrators can connect two CS141 and let the communication of the UPS work with both devices: By doing so, two different CS141 can communicate to according networks without additional hardware.

RS232 UPS interface:

The CS141 provides a standard RS232 interface to allow establishing a serial connection to any UPS providing this standard.

Note:

Please use only the original UPS communication cable supplied with the UPS. In case of using a contact UPS, choose the special designed cable of the manufacture. If you have any questions regarding special connection cables, refer your UPS dealer.

Real-time logfile support:

The CS141 provides a proven compilation of logfiles to reconstruct a complete timeline in case of critical incidents. This logfile is accessible via UNMS, UPSMAN, WebGUI and FTP or can be send via mail to configured mail-accounts.

Advanced mailing capabilities

Each model of the CS141 family provides the capability to connect to any mail server using standardized encryption technologies.

Unique and special hardened web interface:

The unique build-in Web server of the CS141 displays all information about the device itself, connected sensor and external hardware. The software module UPSView inside the CS141 can also be used to display a graphical representation of these data.

To Access the web interface administrators and technicians may just use common browsers (Edge, Firefox, Chrome, Safari etc.).

MODBUS:

Modbus is the standard protocol used in industrial applications for monitoring and building management. All devices of the CS141 family therefore provide as standard a MODBUS over IP interface. In addition, CS141 with COM2 connector provide MODBUS over RS232 (CS141L & SC) and Modbus over RS485 (CS141L, SCM).

SNMP:

The SNMP (Simple Network Management Protocol) is a standard protocol for monitoring installations via IP networks. The protocol is defined and standardized in RFC specifications. UPS systems generally use the RFC 1628 specification as MIB, which defines UPS-specific devices. The adapter communicates via SNMP using the UPS standard MIB RFC 1628. This MIB is supported by most SNMP software products. Therefore, it is usually not necessary to insert an own MIB into the SNMP software. Systems that do not yet include this standard UPS MIB can download the RFC1628 from our website and compile the MIB subsequently. To do this, copy the MIB file into the corresponding MIB directory of your SNMP station and compile this file. First, however, search for a UPS MIB in the MIB tree. This should correspond to an RFC1628 standard MIB.

UPSTCP:

The most common way to communicate with the CS141 adapter is TCP. CS141 includes UPSTCP, which provides you with a complete API interface to integrate your adapter into the network. This interface is supplied on request to manufacturers of software to enable their own integration. A ll other users use TCP for access via a web interface (UPSVIEW, UPSMON, UNMS) or SNMP or MODBUS over IP.

BACnet

BACnet is another major standard that is mainly used in large building infrastructures. With BACnet, complex nesting and overlapping device structures can be monitored. "BACnet over IP" is based on TCP/IP, but extends the protocol with parts necessary for building management. The CS41 can be seamlessly connected to any network via BACnet over IP.

Remote Syslog

With Remote Syslog, the CS141 / BACS WEBMANAGER logfile options are aimed at system administrators who manage log files via central interfaces in the network and evaluate them automatically and sort them according to interesting incidents.

Tools for network analysis

The CS141 WEBMANAGER provides all the tools needed to carry out even complex network analyses on site.

Malfunctions in the local network segment can thus be systematically spotted and finally identified - benefit from the unique possibilities of being able to investigate all connected devices as well as the surrounding network on site.

Role based user management

The CS141 / BACS WEBMANAGER offers a freely configurable user management - configure in free text any user names including spaces and special characters and assign a special user role to these users. The CS141 will dynamically show and hide the menus reserved for the user.

RADIUS

With RADIUS, the CS141 provides a direct method to manage access via a centralized database system and also offers optional local user management to in case of malfunctions. Depending on the configuration type, technicians can optionally be authenticated via a RADIUS, or receive direct access to the WEBMANAGER in case of emergency.

802.1X PAE

Security for your networks without any compromise - The CS141 / BACS WEBMANAGER meets with standard 802.1X PAE to support native connectivity to a secured network, you do not need to configure security exceptions in your network port configuration anymore and create potential security vulnerabilities in your IT network concept!

Security Certified: UL2900-1

In 2023, the CS141 is the only device on the market that fully complies with the strict requirements of UL 2990-1 and, with its wide range of functions, can be adapted 100% to almost any existing safety concept.



Network integration of the CS141

All models of the CS141 family are configured exclusively through the specially designed web interface.

In order to facilitate the initial configuration or a quick on-site intervention, the CS141 family Web Manager is preset to the hard-coded IP address 10.10.10.10:

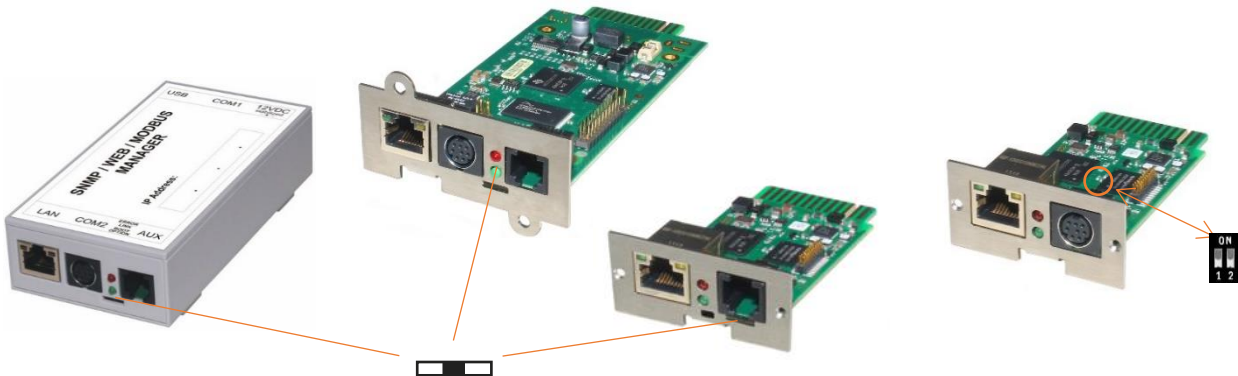

In factory default setting, the sliding switch is in the center position and the CS141 is in configuration mode. Due to its more compact design, the CS141 MINI breaks the standard and uses on-board dip switches instead of a sliding switch:

Both dip-switches set to off position activates the configuration mode.

In this mode, some functions such as IP address data are configurable, but available only as soon as CS141 is switched to regular operating mode.

The following table lists regular operating modes:

<p>Sliding switch center position / DIP 1 + 2 OFF:</p> <p>Enables configuration mode. After reboot the hard-coded IP address 10.10.10.10 is active.</p>	
<p>Sliding switch to the right / Dip 1 OFF + 2 DIP 2 ON:</p> <p>Automatic IP addressing: DHCP is activated and an IP address is set automatically. Check the MAC address of your CS141 to identify the IP address in the DHCP server table.</p>	
<p>Sliding switch to the left / DIP 1 ON + DIP 2 OFF:</p> <p>Use of the IP address values manually configured. If DHCP is used, the IP address needs to be blocked for single usage.</p>	
<p>CS141 Mini HW141) special feature:</p> <p>Both Dip-Switches ON:</p> <p>Enables the rescue-mode for advanced system maintenance operation.</p>	

Note

Die CS141HW161 Produktserie verwendet keine DIP-Schweiche mehr, um den Betriebsmodus zu wechseln. Es werden ausschließlich die Schiebeschalter bzw. der Rescue-Pin verwendet.

Initial configuration 10.10.10.10Preparation at the CS41

Prior to commissioning, ensure the slide switch on the front is set to center position. In case of CS141Mini, both Dip switches of the CS141 MINI has to be set in OFF position. After start up, the CS141 can be runs in configuration mode, available at IP address 10.10.10.10.

Note:

Changing the mode via the hardware switches requires a reboot of the CS141. You can perform the restart in two ways:

By removing the power supply (hardware reset)
Using the Restart feature to be found inside the Tools menu (Software Reset)

This operation does not apply the UPS the CS141 is connected to - the functionality will be kept up independently to the CS141.

Preparing the Workstation

After starting, the CS141 Web Manager can be found using the following network address:

IP address 10.10.10.10
Subnet Mask: 255.255.255.0

Depending on the type of connection you choose, the service computer can be connected directly to a crossover cable or via the local network segment.

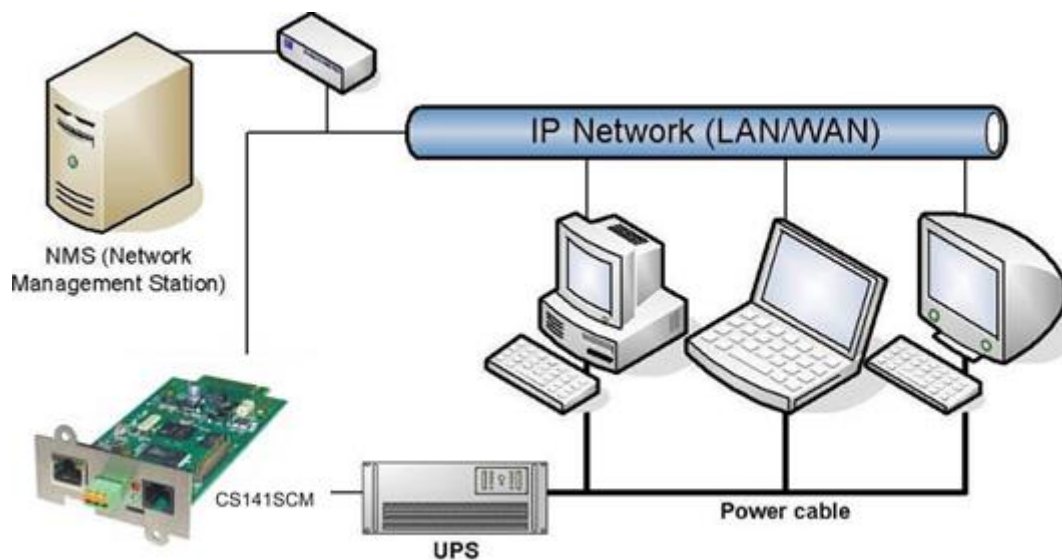

This is recommended network settings for the client PC:

IP address 10.10.10.11
subnet mask of 255.255.255.0
Gateway 10.10.10.100 (Only interesting in case of a gateway is present in this network segment)
DNS: none (Will only work in case of a DNS server is available=)

Note: Some operating systems are sensitive to gateway and DNS settings, for others you can leave these fields empty or enter 0.0.0.0 / 8.8.8.8.

Check your service computer settings by opening a console and entering the following command:

PING 10.10.10.10

Obey whether the settings of your service computer work by opening a console in order to enter the command

PING 10.10.10.10.

```
C:\Users\Gunnar>ping 10.10.10.10

Ping wird ausgeführt für 10.10.10.10 mit 32 Bytes Daten:
Antwort von 10.10.10.10: Bytes=32 Zeit<1ms TTL=64
Antwort von 10.10.10.10: Bytes=32 Zeit<1ms TTL=64
Antwort von 10.10.10.10: Bytes=32 Zeit<1ms TTL=64
Antwort von 10.10.10.10: Bytes=32 Zeit<1ms TTL=64

Ping-Statistik für 10.10.10.10:
    Pakete: Gesendet = 4, Empfangen = 4, Verloren = 0
    (<0% Verlust),
    Ca. Zeitangaben in Millisek.:
    Minimum = 0ms, Maximum = 0ms, Mittelwert = 0ms

C:\Users\Gunnar>
```

If the settings are correct, the CS141 will respond accordingly.

As soon as the CS141 answers correctly, open a web browser. To access the Web interface of the CS141, open a Web browser and enter `http(s)://10.10.10.10`

Adding a route

Within larger installations with well-defined domain services, it may be helpful temporarily editing the routing table.

In case of using a route, ensure the CS141 is located within the same network segment and is therefore directly accessible

Example: Adding a route into a Windows-driven Computer:

1. Run the command console `cmd` as *administrator*
This is important due to the fact, Windows requires a user with local administration rights to add a route.
2. Enter the following command: `route add 10.10.10.10 <IP address of your system>`
Windows will accept the command and return `OK`

```
C:\Windows\system32>route add 10.10.10.10 192.168.200.17
OK!
```

In order to check the new route, enter the command `route print`

```
IPv4-Routentabelle
=====
Aktive Routen:
  Netzwerkziel   Netzwerkmaske   Gateway           Schnittstelle   Metrik
  0.0.0.0        0.0.0.0         192.168.200.1    192.168.200.17  20
  10.10.10.10   255.255.255.255 Auf Verbindung   192.168.200.17  21
  127.0.0.0     255.0.0.0      Auf Verbindung   127.0.0.1       306
  127.0.0.1     255.255.255.255 Auf Verbindung   127.0.0.1       306
  127.255.255.255 255.255.255.255 Auf Verbindung   127.0.0.1       306
  192.168.200.0 255.255.255.0  Auf Verbindung   192.168.200.17  276
```

Under active routes, 10.10.10.10 should be seen. As an additional test, use the command `ping 10.10.10.10` to verify the CS141 web manager is responding as expected.

Note:

In configuration mode, only one CS141 with the default IP address of 10.10.10.10 can be operated.
If you connect several devices at the same time this way, a network conflict is unavoidable.

Using the DHCP Option

The DHCP mode

Since the models of the CS141 family can fulfill many functions due to their flexibility, it is a very realistic scenario that you need to commission several devices at the same time within an installation procedure - Unfortunately there is no fixed IP address that can be assigned for the moment.

To avoid a network conflict, activate the DHCP mode for automatic IP address assigning:

Slide the slide switch to the right, i.e. to the outer edge of the CS141. For the CS141 Mini, set dip switch 1 to OFF and move dip switch 2 to ON. Next reboot, the web manager will boot in DHCP mode according to the hardware configuration and obtain an IP address from your network.

Required information for finding CS141 in DHCP-Mode

To identify the devices, please note the MAC address including location data before proceeding hardware installation. The MAC address can be found on any CS141 web manager as a unique sticker:

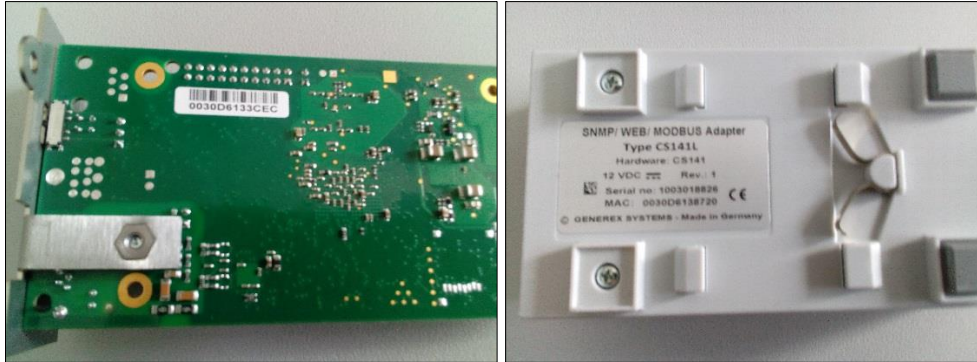

Ensure a suitable DHCP server is available for this operating mode, otherwise the card will not be able to get valid IP address data automatically.

CS141 MINI and CS141 / R2

Due to the compact design, the label sticker of CS141 MINI and the CS141 / R2 differ and shows only the last three octets of the MAC address.

The MAC address of a GENEREX- network interface starts with these address values:

00-30-d6-xx-xx-xx

The last three values can be found at the label on the back of the CS141 MINI or CS141 R2:

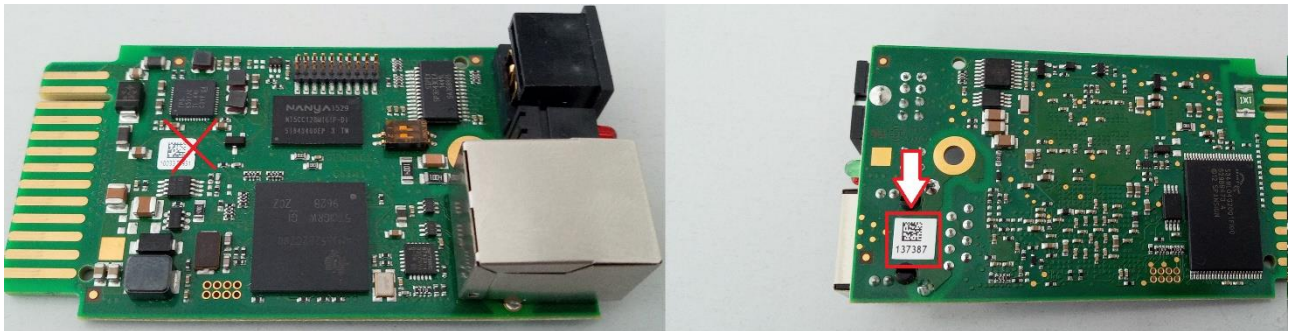

A common bar code scanner that can handle QR codes or a smartphone with a QR- Code app will display the complete MAC address.

Note

Please notice that you use the sticker on the back. This will show the last three octets of the MAC address. When on installation site, you can simply figure out the MAC address:



In this case, the MAC address is 00-30-d6-13-73-87

Netfinder: Search for IP-addresses used with CS141 devices

The Netfinder is a software tool that can display all CS121 and CS141 devices that can be reached inside a specific network segment. It is available at the local support CD and at www.generex.de.

To perform a quick search for valid IP addresses, use the tool Netfinder.

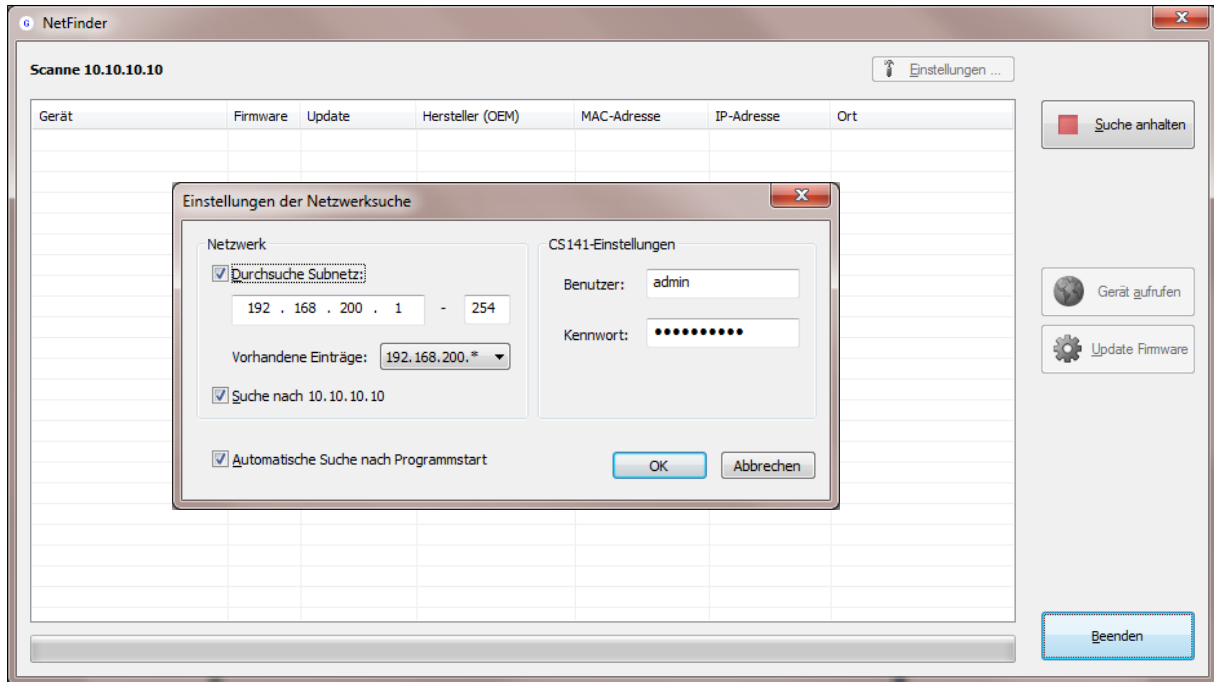

The default search generally refers to the network segment the service computer resides. To scan other networks and subnets for CS121 or CS141 installations, it is necessary to specify the appropriate IP address ranges.

Gerät	Firmware	Update	Hersteller (OEM)	MAC-Adresse	IP-Adresse	Ort
CS141L	1.61	Nicht nötig	ABB (36)	00-30-d6-16-1d-e7	192.168.222.106	
CS141BSC	1.60	Nicht nötig	Online (4)	00-30-d6-13-3d-eb	192.168.222.104	
CS141R_2	1.60	Nicht nötig	Piller (3)	00-30-d6-12-6e-c7	192.168.222.107	
CS141L	1.56	Verfügbar (1.58)	ABB (36)	00-30-d6-12-60-70	192.168.222.108	
CS141LM	1.60	Nicht nötig	AMG Accent Monitorin...	00-30-d6-12-0f-2b	192.168.222.110	
CS141SC	1.60	Nicht nötig	Salicru (82)	00-30-d6-16-bb-f3	192.168.222.112	
BACSKIT_B4	1.60	Nicht nötig	Generex (12)	00-30-d6-12-60-61	192.168.222.114	
BACS II Webmanager BUDGET	5.62	Nicht nötig	UPS LTD (84)	00-03-05-18-77-6A	192.168.222.113	
BACS II Webmanager BUDGET	5.62	Nicht nötig	Hoppecke (91)	00-03-05-18-59-7A	192.168.222.103	
CS131 16MB	5.62	Nicht nötig	ALTERVAC (92)	00-03-05-18-6A-A4	192.168.222.111	GENEREX Hamburg Garage
CS141BSC	1.60	Nicht nötig	CET (81)	00-30-d6-12-6f-9d	192.168.222.119	
CS131 16MB	5.34	Verfügbar (5.62)	Generex (12)	00-03-05-18-96-A2	192.168.222.123	

The GENEREX Netfinder software provides a detailed overview of all devices in the network and allows quick and easy access to the web console of the respective manager.

Note:

In DHCP mode, IP addresses may change sporadically depending on the network configuration. Therefore, several Webmanager monitored by a parent system such as UNMS II should receive a fixed IP address.

In any other case, technicians can easily detect and access installed devices by using Netfinder.

Configuring the CS141 device

Differences between configuration mode, rescue mode and operation mode

Each model of the CS141 family will be configured exclusively by an intuitive web interface. Independently to this common ground, the web managers offer four valid operating states, which fundamentally differ from each other.

1. The configuration mode

The configuration mode is the default preset on delivery:



The slide switch is in center position and the dip switches of the CS141Mini are both set to OFF. The web manager can be reached via hardware-coded preset IP address 10.10.10.10 and allows all system-relevant settings. Since the CS141 generally uses the preset IP address in configuration mode, this mode allows importing backup data and to be adjusted after restart without harming the network.

2. Operating mode

Depending on the setting, the sliding switch will be set to left or right position. In case of CS141Mini, Dip switch 1 or 2 is switched on



The CS141 can be run in two different operation modes:

In manual mode, enter the IP address information. Please note that incorrect settings may cause address conflicts on the network or the settings made may not work. The data required for manual mode can be obtained from local system administrators.

Note:

In manual mode, the data is entered by technicians and thus permanently assigned. The CS141 will use this data to make itself known in the network. Assigning an address twice will cause a network conflict. In this case, switching back to configuration mode at any time is possible to reach the Web Manager at the default IP address 10.10.10.10.

In DHCP mode, the CS141 automatically inherits settings assigned by a server and uses them for the IP address settings. The web server takes over the administration of the IP address data. After the startup process, the web manager can be found using the tool *Netfinder*.

Note:

As a rule, DHCP-assigned IP addresses via automatic mode are reserved for specific time. DHCP clients therefore ask after 50% of this time window whether the IP address is still valid or will be assigned to another client. How statically the DHCP server allocates IP addresses is a decision the system administrators make.

Due to this fact another IP address can be re-assigned after booting or a CS141 seems to be lost during regular operation.

When selecting the operating mode, the function of the CS141 within the network should be considered:

If the Web Manager runs as an active element within shutdown solutions or in conjunction with higher-level monitoring structures, a manually assigned IP address makes sense, since an authenticated and fixed IP address must be configured.

As another advantage the CS141 starts faster with preconfigured IP addresses if the DHCP server is not available.

3. The hard-coded DHCP Mode

To enable the DHCP mode, put the sliding switch to the left, and reboot the CS141.



In this operating mode, the CS141 uses the hard-coded DHCP-Mode that overwrites all manual IP settings. For operating, a DHCP server is mandatory.

4. The rescue mode

In this mode, an additional jumper is set and the slide switch center position.

The Webmanager can access two ROMs for booting. Therefore, this failsafe design is able to contain the current firmware as well as the last state before the firmware update including the configuration file. When the web manager is set to rescue mode, the logic starts from the last known state and is initially fully operational again but indicates in the general system information that the web manager is in rescue mode.

The rescue mode represents a manually chosen emergency operation state and is intended to repeat a faulty flash process.

Before you startInstallation examples

The CS141 was designed to provide a maximum of flexibility and freedom during the installation - as a result the CS141 match the tasks of modern UPS systems as well as expectations coming with it.

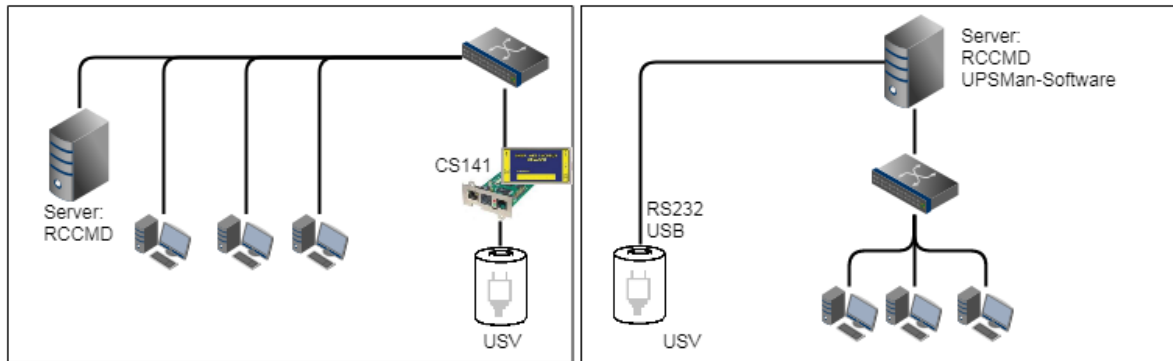
Case one:

The central role of the UPS is to ensure emergency power until the server shut down securely during main power loss. The complete shutdown routine is controlled by the CS141, as this is a full-fledged manager that can act independently. As an alternative to the CS141, the shutdown routine can also be initiated via the UPSMan software. Further servers need only one more RCCMD license.

Two separate networks

It becomes more difficult as soon as emergency power coming one UPS has to ensure the shutdown of two servers inside separate networks without linking possibilities:

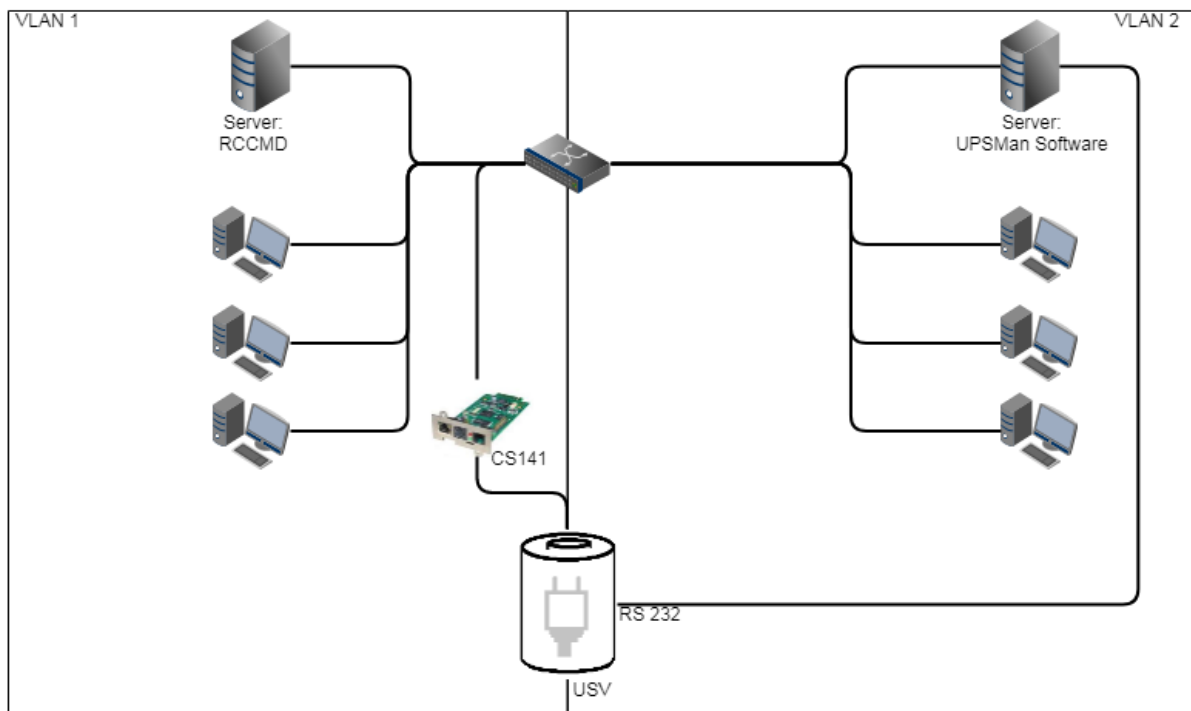

In this case, the UPS becomes a central role inside the network's emergency power security.

Since the VLANs represent physically separated own network segments, only one server can be secured by the CS141. The UPSMan software will secure the second server:

Once Installed directly on the server, it communicates with the UPS via the COM port of the server and offers the same functionality as the CS141 including a full support of RCCMD. Therefore VLAN 2 represents a "software only" solution that does not require a CS141 as additional hardware. Please note that the UPS must support slot / RS232 port simultaneous operation if you want to use both ports.

The required RS232 connection is not available or the installation of software is not possible?
 Just use servers providing 2 network cards:

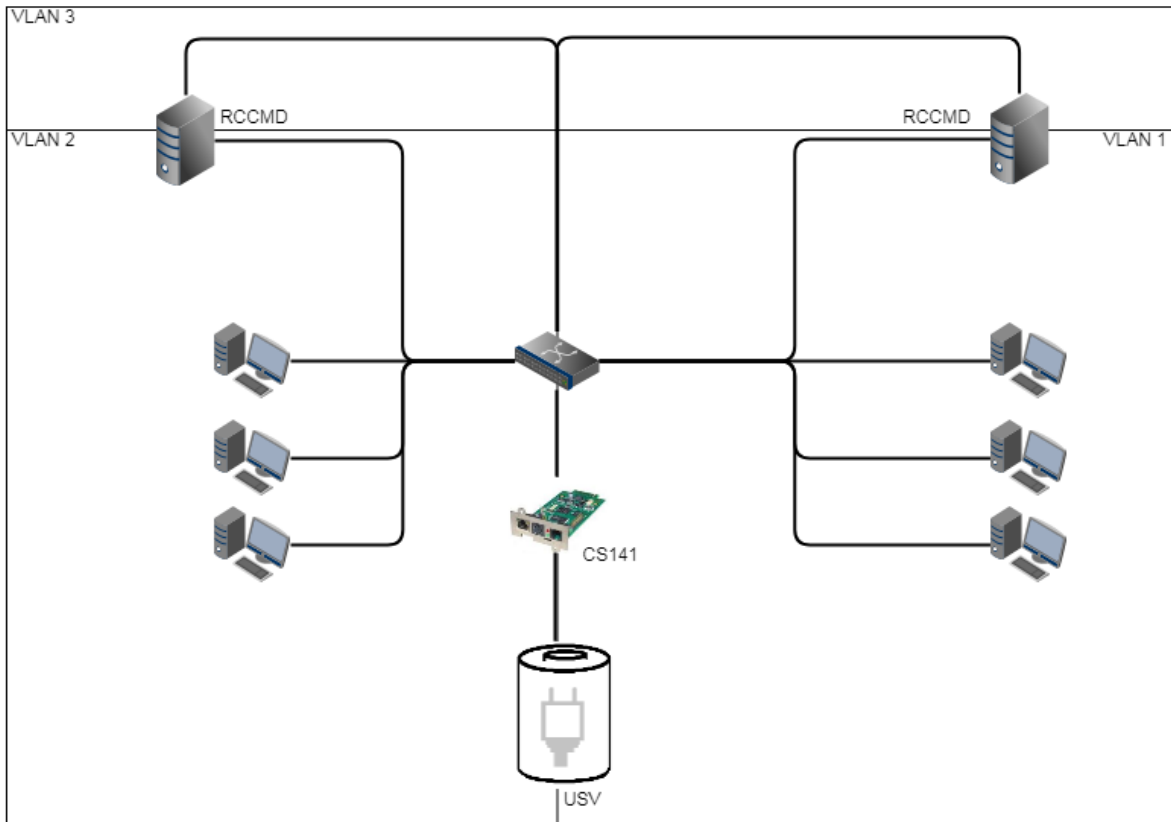

If you have chosen a solution with two network cards and the UPS provides a usable RS232 interface, this solution allows future installations - even complete closed up networks are possible.

Pipe Through

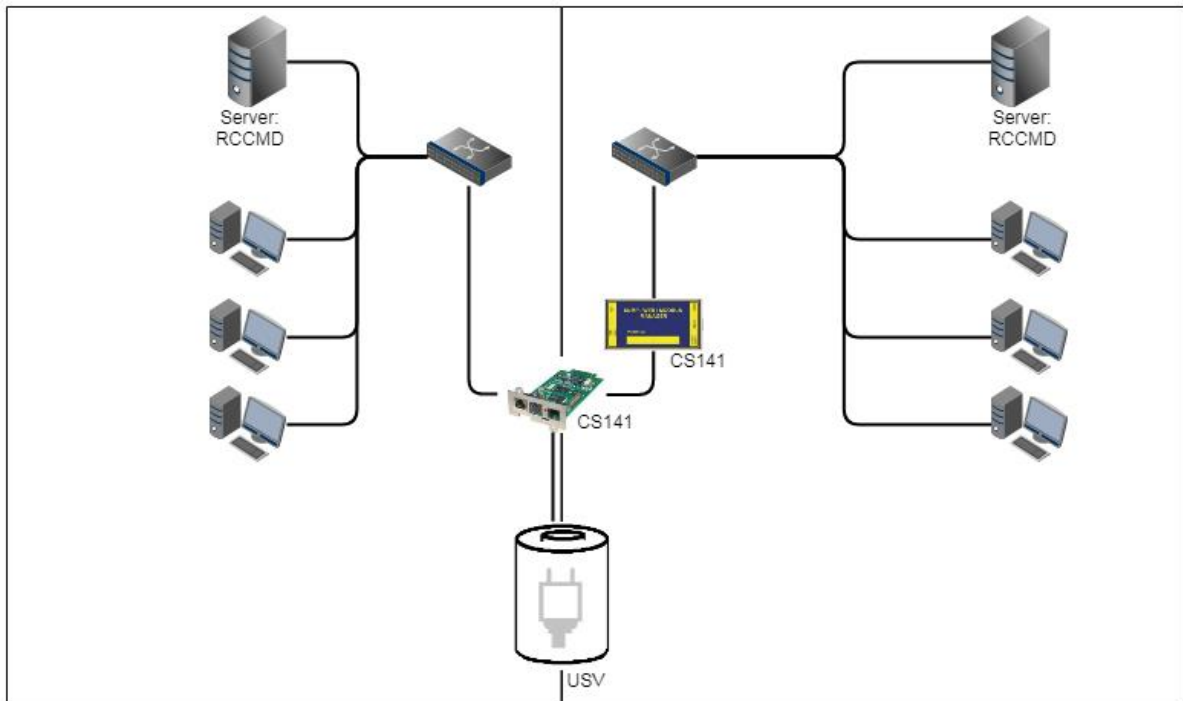

In some companies, physical separation of the networks is essential, but the UPS does not offer the option of operating RS232 and slot parallelly. In this case, the signal can be looped by the pipe-through function: This feature allows two CS141 jointly perform the same function inside of complete separated networks. Furthermore, different CS141 versions can be combined as desired - Even the combination CS141 / UPSMan software is possible for a maximum of flexibility.

Complex structures

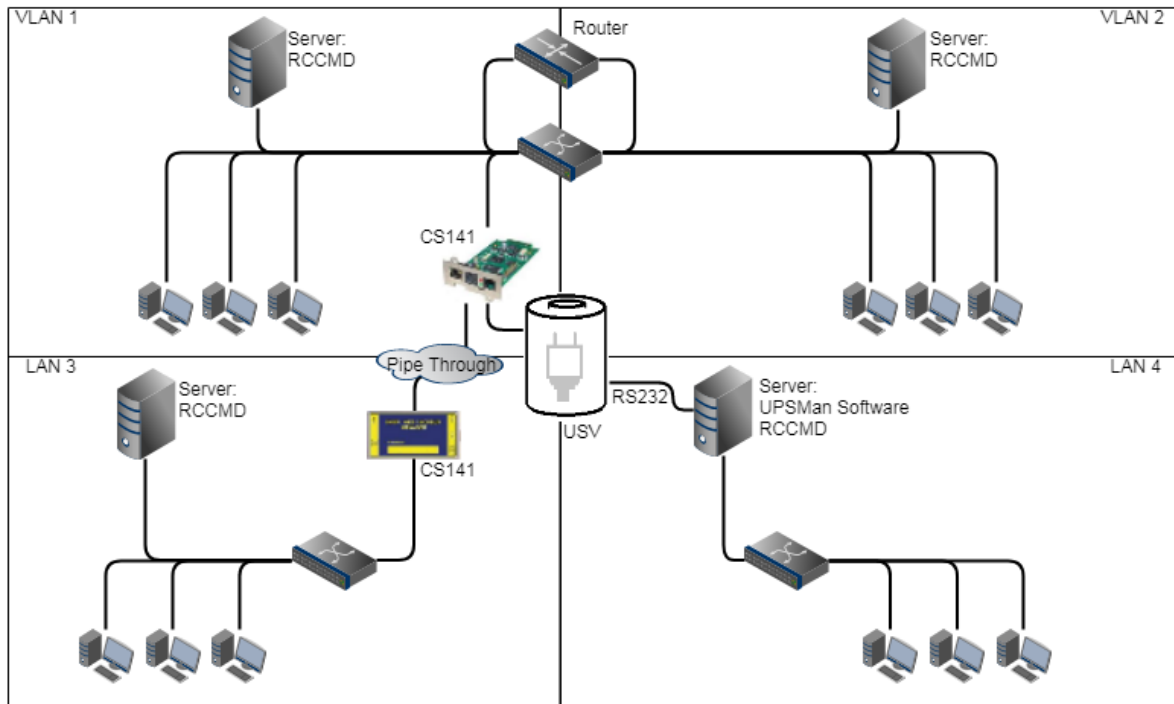

In this example, VLAN 1 and VLAN 2 were logically linked by a router to allow one CS141 sending RCCMD commands to all servers inside of VLAN 1 and VLAN2. At the same time, the Pipe Through function allows the same signal coming from the UPS to a third CS141 physically installed inside LAN3. Due to this fact, the CS141 can completely control LAN3 and ensure a shutdown routine using RCCMD. LAN 4 is connected to the UPSMan software via the RS232 interface and the server itself can act like a CS141 including full RCCMD functionality. This example demonstrates a complex system:

- two complete separated networks
- two logical linked networks
- on central UPS solution to provide auxiliary power in case of main power is down.

Each CS141 or UPSMan is completely informed about the current UPS alarm state. Furthermore, each network can be managed for its own without harming others.

Note.

The UPSMAN software also handles communication via USB - If your UPS supports parallel operation, it is possible to combine USB, Slot and RS232.

Required Ports

The CS141 provides many functions to communicate with network nodes. For the communication so called "ports" are needed. Some of these ports are international standards within your EDP, others must be configured exclusively for the CS141. The following list contains all ports entered by default for the CS141:

Description	Port	TCP	UDP	Is CS141 configuration menu available?
Echo	7	X	X	No
WOL	7 oder 9	-	X	YES
ftp-data	20	X	-	No
SFTP	22	X	-	No
http	80	X	-	YES
https	443	X	-	YES
SNMP CS141 Geräte Listener	161	-	X	No
SNMP Management Software Listener	162	-	X	No
SMTP	25	x	-	YES
RCCMD	6003	X	-	YES

UPSMAN/ UNMS	5769	X	-	YES
SNMP Trap	162	-	X	No
Time (rfc868)	37	X	-	No
Time (snmp)	123	X	-	Nein
Modbus over IP	502	X	-	YES
BACnet	47808 oder 47809	-	X	YES
Remote Syslog	601	X	-	YES
RADIUS	1812	X	-	JA

For some functions, the port assignment is dynamic and must be managed or specified by the network administrator depending on the network. If you require additional ports, this is listed at the appropriate place within this documentation. The number of the port to be used can be obtained from the responsible network administrator.

Note: Keep an eye on the firmware version you are using

This user guide covers all the menus that you can encounter when configuring a CS141. Basically, it is written for firmware version 2.16 and subsequent versions with a special eye on SITEMANAGER 6 and SITEMONITOR 6. Many menus will be available for all products of the CS141 family and the configuration method is similar. Once you understood the concept, you will be able to configure any device of the CS141 family intuitively.

If you cannot find a menu, there are several reasons:

- The CS141 you are using does not offer this feature
- The firmware version you are using is older so the feature this manual describes is not available
- The configuration menu is present, but has been delayed by the ongoing development process

Basic settings and passwords

After entering the IP address, the CS141 responds with its web interface and prompts for a password

There are three users with different system rights to choose from. The users are predefined, the passwords can be freely defined:

User: admin	Password: cs141-snmp	... System administrator, complete menu tree accessible
User: engineer	Password: engineer	... Technician, administrative restricted system access
User: guest	Password: guest	... guest account, only status indicators visible

To start initial configuration, log in with user admin and default password cs141-snmp

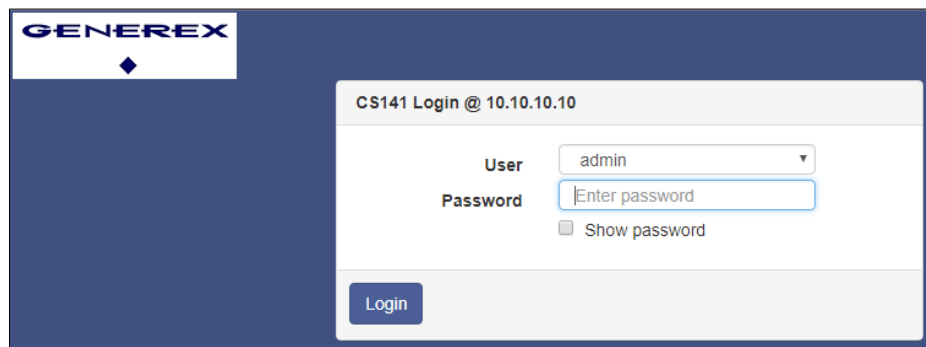

Note:

Modern web browsers are designed to display websites as fast as possible. Among other things, special techniques are used to pre-load images, pages and query masks are loaded into a buffer for a faster review. In some cases, this web browser behavior may result in screen errors.

If these phenomena occur, update the browser by pressing CTRL + F5 or clear the cache of the web browser and deactivate additionally installed tools and addons, which could obstruct the presentation.

CS141 configuration menu overview, FW 2.16 onwards

Config Information Center

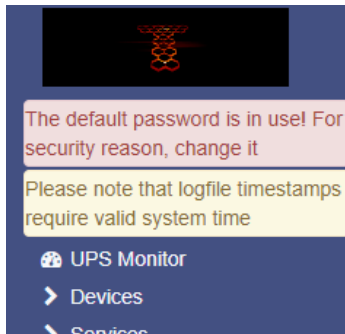

This area is reserved for the CS141 to provide general information about the current configuration status and possible configuration errors or security issues.

Example 1:

You have commissioned the CS141, but not changed the default usernames and passwords.

Hackers have discovered that modern server structures produce a large amount of background assistance systems. Administrators often missed including these stand-alone devices in the key issues paper on cybersecurity. The C141 therefore provides an according hint:

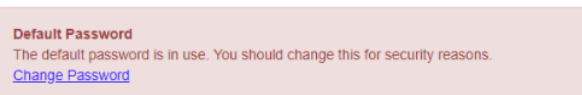

Since this is a well-known user made security issue, the CS141 informs that the standard passwords, as described in manuals, handouts and quick start guides, grant an unwanted person administrative access. Due to the severity of this security issue, the notice is colored red.

Example 2:

Less relevant to the running system as long as everything is running well, but not to be underestimated - that's why it's yellow - wrong time stamps in log files:

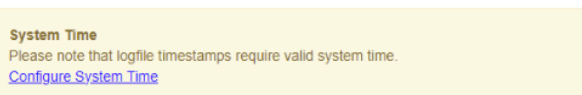

Each CS141-based device logs numerous measurement data and relates them to system events within a timeline. Depending on the expansion level and connected devices, a CS141 therefore can be used to automate many system functions and even trigger or manage emergency measures in case of problems. Although these system events are recorded and executed chronologically correct, without a correct time stamp, evaluation of log files can be very tricky.

Example 3: Hints like available firmware updates



Firmware updates provide new features, improve performance, eliminate minor bugs, new UPS models, etc. , but also hold system critical security updates. Depending on the cruciality, it can be a notice or a system-critical recommendation (red). However, this notice can only appear if the CS141 is somehow connected to the internet and this function is enabled.

This is the CS141 menu tree without expansion modules.

If you connect additional modules in order to extend functionality, corresponding menus are automatically displayed after installing and activating the functions.

This menu tree shows all basic functions each CS141 model provides:

<ul style="list-style-type: none"> 🏠 UPS Monitor - Devices ⚙️ Setup - UPS ⚙️ Setup 🔔 Events 🔧 Functions ⚠️ Custom Thresholds - Services ⚙️ Setup ✉️ EMail ✉️ EMail-Traps ⚙️ SNMP Agent ⚙️ Modbus ⚙️ BACnet ⚙️ RCCMD 🌐 Webservice 📄 Rsyslog - System 📄 About ⚙️ General 🌐 Network 🔒 Security 🕒 Date & Time 📅 Scheduler 👤 Users 🔧 Tools 🔧 Wizard 📁 Backup 📁 Update - Logfile 📄 EventLog - UPS 📄 DataLog 📈 DataLog Chart 🚪 Logout admin 	<ul style="list-style-type: none"> ➔ Monitoring Screen: Current selected UPS ➔ Main System Tab: Devices <ul style="list-style-type: none"> ○ General Interface Settings ➔ <i>Sub menu: UPS setup</i> <ul style="list-style-type: none"> ○ Select the uPS ○ Configure system events and jobs ○ Basic UPS function menu ○ Select and configure customizable thresholds ➔ Main System Tab: Services <ul style="list-style-type: none"> ○ Enable / Disable the services and service ports ○ Configure the E-Mail client ○ Configure the E-Mail trap client (UNMS) ○ Configure the SNMP Services (v2/v3) ○ Configure Modbus over IP / Modbus RS232 (485) ○ Configure BACnet over IP ○ Enhanced RCCMD settings ○ Setup options for the intergrated web server ○ Configure the Remote Syslog Client ➔ Main System Tab: System <ul style="list-style-type: none"> ○ About Box: Basic system information, firmware version, etc ○ Basic system setting (language, contact data, temp...) ○ IP address configuration: IP address, gateway, etc. ○ 802.1X Port access configuration ○ Configure date, time, timezone, NTP services, etc ○ Scheduled job settings to execute independent to system events ○ User configuration, RADIUS setup, etc. ○ Tool box for advanced network analysis ○ Setup Wizard: This tool will guide to the most basic system settings ○ Backup creation / restoring area ○ Run a firmware update ➔ Main System Tab: Logfile <ul style="list-style-type: none"> ○ Show all local recorded system events ➔ <i>Sub menu: Show UPS log files</i> <ul style="list-style-type: none"> ○ Show a data table with all measurements ○ Show a graphical version of the DataLog with filter options ➔ Quit this session and log out
--	--

Extended menu trees

Depending on the CS141 model and available additional modules, additional menus are available. Please note that not every model can provide the following menus:

Sensor menus

Depending on the type of sensor, the following menu will be added automatically:

1. Standalone sensor on COM 2

After selecting sensor at COM 2 Sensor and as sensor type SM / T or the combination sensor SM / TH, following menus will appear automatically:



The screenshot shows the GENEREX menu system with the following structure:

- UPS Monitor
- Sensor Monitor
 - Devices
 - Setup
 - UPS
 - Sensors
 - Setup
 - Events

Annotations for the screenshot:

- Sensor monitoring screen
- **System Tab: Devices**
- **Sub menu: Sensors**
- Configure measuring range, alarm marker, operating range
- Configure jobs to the alarm marker

2. SENSORMAN2 at COM 2

After selecting sensor at COM 2 Sensor and as sensor type SENSORMAN2, following menus will appear automatically:



The screenshot shows the GENEREX menu system with the following structure:

- UPS Monitor
- Sensor Monitor
 - Devices
 - Setup
 - UPS
 - Sensors
 - Setup
 - Matrix
 - Events

Annotations for the screenshot:

- Sensor monitoring screen: All sensor data in real time
- **System Tab: Devices**
- **Sub menu: Sensors**
 - Configure up to 8 sensors, digital inputs and outputs
 - Combine different sensor events to combined alarm marker
 - Define Jobs to single sensor events or combined alarm marker

With the sensor matrix, an additional function is available that allows to combine single sensor events to collective events.

3. CON_AUX4 / CON_R_AUX4 selected at COM 3

The following menus are added when you connect a CON_AUX4 or a CON_R_AUX4 relay card to the COM 3 port of the CS141



→ AUX monitoring screen

→ **System Tab: Devices**

→ **Sub menu: AUX**

→ Relay Card basic setup

→ Event handling configuration dialog CON_AUX4 or CON_R_AUX4

4. BUZZER selected at COM 3

The CS141 provides an additional buzzer for advanced acoustical alarm notifications. The following menu will appear when you choose the Buzzer at COM 3 of the CS141:



→ Buzzer monitoring screen

→ **System Tab: Devices**

→ **Sub menu: Buzzer**

→ General buzzer setup, frequency, on / off, etc.

→ Buzzer event handling: Jobs to do because a Buzzer is active

6. BACS selected at COM 3

BACS® - the "**B**attery **A**nalysis & **C**are **S**ystem" - is the most advanced system on the market to manage stationary battery systems. It is a standalone battery monitoring and management system that can be easily integrated into your network infrastructure.

With its intelligent web-technology configurable management technology, it cyclically checks the internal resistance, the temperature and the voltage of each individual battery. In addition, it can readjust the charge voltage of each battery and manage environmental readings (temperature, humidity, hydrogen gas content) as well as loads (UPS, inverters, and other devices). The accumulators are thus always kept in the optimal working range.

Note:

Since the configuration of the system is independent to the rest of the functions, BACS functions are listed separated at Part II of this manual.

The Setup Wizard

For this configuration step, navigate to the following menu:



When you use the CS141 for the first time, the welcome screen will automatically start with the wizard. Please note that you cannot switch through the masks directly, you need to follow by pressing *next*.

The screenshot shows the 'System Setup Wizard' window with the 'General' tab selected. The interface includes the following elements:

- Navigation tabs: General, Network, Date & Time, UPS Setup, Review.
- Form fields: Location, System Contact, and a checked checkbox for 'Check Firmware Update'.
- Section header: 'Region'.
- Form fields: Language (set to 'English') and Temperature (radio buttons for 'Celsius' and 'Fahrenheit').
- Buttons: 'Back', 'Next', and 'Cancel'.

The Setup Wizard helps to set up a basic configuration:

General

Provides basic information about the location to be installed, system language, responsibilities and temperature scale.

Network

Enter the network configuration - The necessary data can be obtained from the local administrator.

Date & Time

Provide basic information about the date, time, and time server

UPS Setup

Enter information about the UPS the CS141 shall be connected to

Review

Check data before you finish the configuration process before finishing.

Note:

The Setup Wizard simply summarizes basic settings and provides a quick and convenient solution that can be used to make or change basic settings. If you want to perform the configuration completely manually, click here Cancel - You can always restart the Setup Wizard in the configuration menu.

But be careful: Some entries such as UPS configuration have dependencies to advanced configuration entries the Wizard does not include.

Configuration mode: Basic settings

For this configuration step, navigate to the following menu:

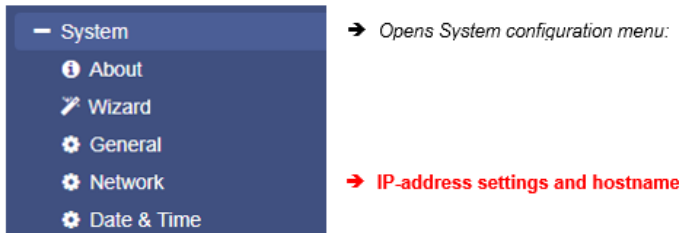

Most settings can be done as long as the CS141 is in configuration mode. Depending on your network settings there could be a problem when performing tests and forwarding functions - they are often not possible on hardware preset 10.10.10.10. Due to this fact it is a good choice to configure all basic settings inside configuration mode and switch to normal mode before starting advanced UPS configuration.

How to configure network settings, open Network:

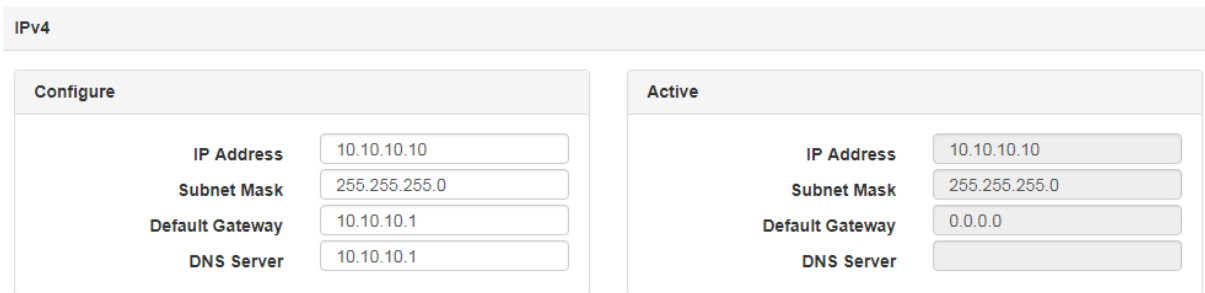

At Configure, enter the IP address data the system shall use. Active shows the current IP address settings used by the system.

It is possible to change the following settings

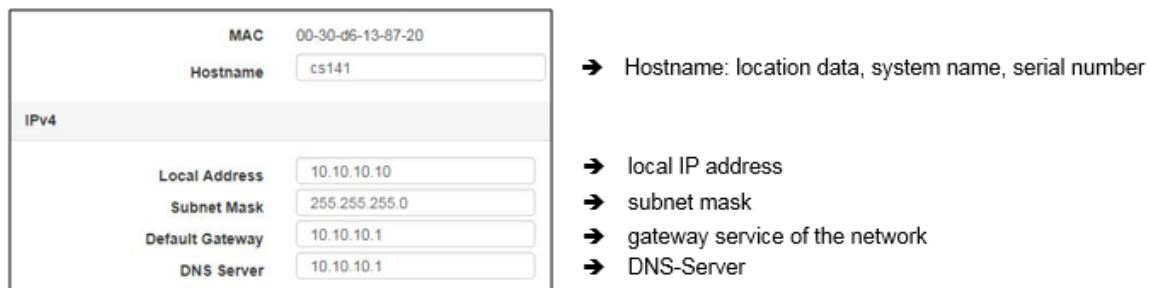

On first startup, the CS141 will get hard-coded information. The required IP address information to enter the operational mode correctly can be obtained by contacting the responsible network administrator. Press Apply to save your settings.

Note:
At this point, the web browser redirects you to the new IP address. Since the CS141 is still in configuration mode, you will receive an error message from your web browser. In this case, ensure to work with the IP 10.10.10.10 and press CTRL F5 to refresh the web browser.

For a first configuration, the Network menu is the only setting you currently need to make in Configuration mode. It is possible to carry out all other settings in regular operating mode.

DHCP mode during initial configuration

While booting in DHCP mode, an according server assigns an IP address to the CS141 device. This IP address can be found comfortable by using the freeware tool Netfinder. Therefore, it is easy to identify the device by the MAC address shown by Netfinder and the address label glued on the CS141 device:

CS141L	1.61	Nicht nötig	Generex (12)	d0-39-72-3b-df-f8	192.168.200.142	
BACSKIT_B4	1.60	Nicht nötig	Generex (12)	00-30-d6-16-b3-4b	192.168.200.148	
CS141BL	1.61	Nicht nötig	ALTERNAC (92)	00-30-d6-12-6f-56	192.168.200.224	
BACSKIT_B4	1.61	Nicht nötig	Generex (12)	00-30-d6-12-60-42	192.168.200.225	
CS131	5.58	Verfügbar (5.62)	Generex (12)	00-03-05-0E-2F-49	192.168.200.227	FB Office

The function open device opens a separate web browser and inserts the IP address automatically. After login, it is possible to access network settings and change the IP address. After rebooting the device with manual mode setting, new IP address setting is active.

By switching back to DHCP mode, these settings are completely ignored and the CS141 falls back to server-assigned address.

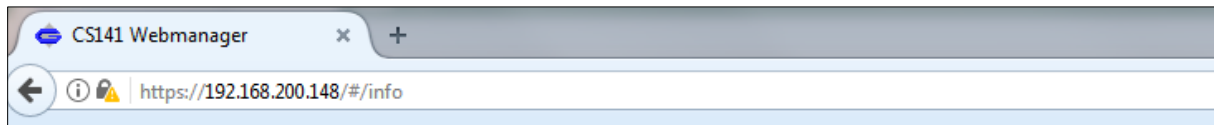

The advantage is as many CS141 into the network at the same time without much effort, which are immediately accessible without the possibility of an address conflict. The disadvantage is the fact that in DHCP mode the IP addresses can change dynamically, which means that higher-level or docked shutdown solutions may no longer be able to access or output errors.

How a DNS – entry works

Basically, there are two methods to address a target system. Either you directly specify the IP address: the CS141 will then address the system directly without involving other system services or server. Or, instead of an IP address, it is possible to use a host name: by doing so, the CS141 will send a request to a responsible DNS service and ask for the IP address assigned to the host name.

Both methods come with their own advantages and disadvantages

- When using host names (e.g. database.steel-colossus.intra), the user can identify the target relatively well, but is dependent on a well-functioning network: the resolution of host name > IP address is managed by a DNS server. When using host names, the CS141 also requires a DNS server, e.g. if RCCMD control signals have to be transmitted to a specific RCCMD client: For each control signal, the responsible DNS server must first be contacted and asked for the IP address of the host. If a network breaks up into individual segments as a result of a fault, a segment without a DNS server will no longer be able to resolve host names.
- Using an IP address is a little more independent to a certain extent, because there is no need for a DNS server. The target IP and network segment is already known, and the RCCMD control signals will function accordingly in the event of a network disturbance close to the DNS server. On the other hand, this method requires fixed IP addresses. If a DHCP server dynamically manages and reassigns IP addresses according to its function, the CS141 job management can hold out-dated information about the target IP address - in case of an emergency, the CS141 may send valid RCCMD commands, but address the wrong target.

Why does the CS141 not communicate its host name to a DNS server, although I have entered the IP address of the server at the DNS settings?

By system / network design, this is not the task of a CS141. If you set the CS141 to DHCP, it contacts the DHCP server during the boot process and communicates for the host name it would like to use.

The DHCP server may accept the request, assigns an IP address and, depending on the configuration, will either comply with the request, i.e. forward the host name to the DNS server. Since a DHCP can also overwrite a host name, the result depends on the configuration of the network, e.g.:

- The IP address is assigned, but no automatic DNS entry is available.
- The IP address is assigned and the host name request of the CS141 is available via DNS.
- The IP address is assigned and the host name request of the CS141 is overwritten.

Note:

If you reserve or block the IP address within the DHCP server and configure the CS141 to use a manual IP address setup, the CS141 will not "register" at system start-up: The fact that the CS141 starts with its own IP address and that the reservation in the DHCP server ensures that the IP address is not assigned elsewhere does not necessarily mean that the DNS server also automatically gets a lookup entry - this to check is a task of an administrator.

Advanced basic settings

For this configuration step, navigate to the following menu:



Enter Location settings

Location data can be read by any software supporting this feature. If used in larger installations with many devices, location data will help to associate installed devices.

Location	<input type="text" value="your location name"/>	→ Enter a physical location the device runs
System Contact	<input type="text" value="administrator, numbers, ..."/>	→ Enter responsible staff or department to be called
Customer Signature	<input type="text"/>	
Check Firmware Update	<input checked="" type="checkbox"/>	→ If checked, the CS141 reports firmware updates

Apply will save the settings and restart according services to activate the new settings instantly. Netfinder will find the new name next to the IP address:

CS141L	1.61	Nicht nötig	Generex (12)	d0-39-72-3b-df-f8	192.168.200.142		
BACSKIT_B4	1.60	Nicht nötig	Generex (12)	00-30-d6-16-b3-4b	192.168.200.204	Allgemeine Anlage 3	
CS141BL	1.61	Nicht nötig	ALTERVAC (92)	00-30-d6-12-6f-56	192.168.200.224		
BACSKIT_B4	1.61	Nicht nötig	Generex (12)	00-30-d6-12-60-42	192.168.200.225		
CS141L	1.61	Nicht nötig	Generex (12)	00-30-d6-12-70-36	192.168.200.231		
CS141L	1.60	Nicht nötig	Generex (12)	00-30-d6-14-21-3c	192.168.200.232		

Regional settings

Region		
Language	<input type="text" value="English"/>	→ Select the language for configuration menus
Temperature:	<input checked="" type="radio"/> Celsius <input type="radio"/> Fahrenheit	→ Select temperature measurement scale

Under Language, select your preferred system language. Supported languages are German, English, Chinese (Simple), French, Spanish, Polish, Portuguese

Under Temperatures, select the unit of measure in which to display the temperatures.

The Difference between Fahrenheit / Celsius

Although initially defined by the freezing point of water (and later melting point of ice), the Celsius scale is officially derived among Kelvin scale: Zero on the Celsius scale (0 °C) corresponds to 273.15 K, with a temperature difference of 1 °C which is equivalent to a difference of 1° K - the size of the unit in each scale is the similar. Therefore 100 °C, the previously defined boiling point of water, equates to 373.15K. Due to the fact the Celsius scale is an interval system, but not a ratio system, means it follows a relative and not an absolute scale.

This is indicated by the fact that a temperature interval between 20 °C and 30 °C is the same as between 30 °C and 40 °C, but essentially 40 °C does not have twice the air heat energy like 20 °C. A temperature difference of 1 °C therefore corresponds to a temperature difference of 1.8 °F.

There both scales are used worldwide, it is important to know in advance which measurement scale to use for configuration.

Note

The CS141 recalculates the values when rescaling the scale and adjusts the settings automatically - but a higher-level system configured to Fahrenheit will inevitably receive incorrect information from a web manager set to Celsius.

This small problem may lead into a big impact, especially if teams are placed inside an international co-operation.

As an example, on December 12, 1998, the Mars Climate Orbiter has entered as programmed the mars orbit, but 170 kilometers lower than planned. Investigations found the reason for this incident: There was a communication issue between two different groups of NASA scientists who performed the trajectory calculations - one used inches and the other meters. They simply forgot to communicate this small fact...:

„The „root cause “... was the failed translation of English units into metric units in a segment of ground-based, navigation-related mission software ...“

Provided services

For this configuration step, navigate to the following menu:



The CS141 uses separate system services for communication, which can be started and stopped independently to each other:

This allows activating and deactivating the functions without having to restart the CS141 completely.

While Modbus and SNMP are used as the industry standard inside almost all higher-level monitoring systems, the UNMS server is only necessary if you use the monitoring software UNMS 2 from GENEREX.

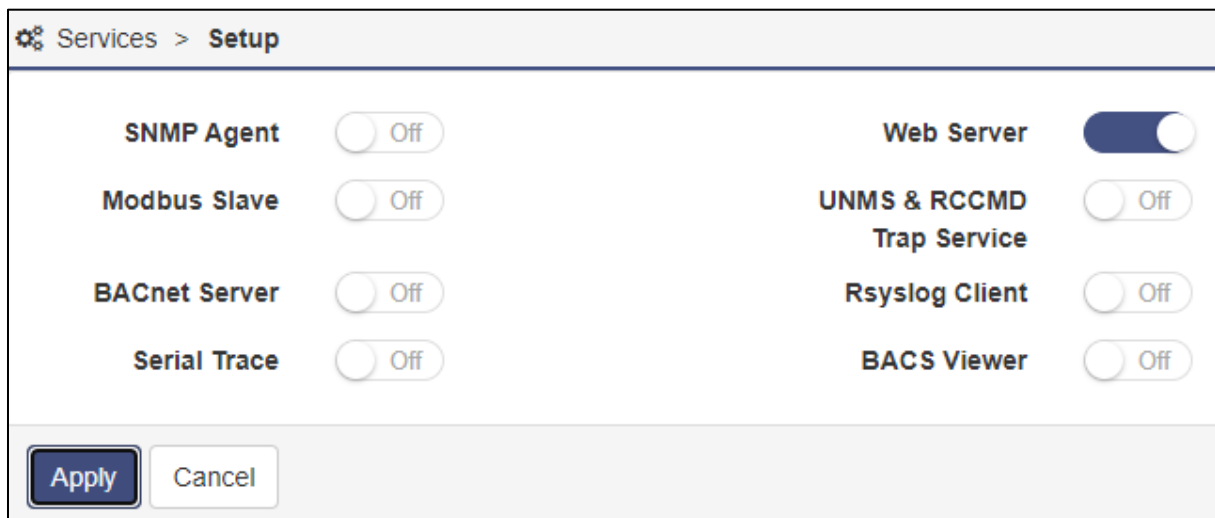

To enable or disable the according service, use the buttons.

Note: Doctrine Change with Firmware 2.14 – Cybersecurity Enhanced!

In accordance with best practice, the default settings were selected in such a way that a quick and uncomplicated integration into existing systems based on standards was possible. With a view to cybersecurity, this has now been changed. All services that are not required for the initial setup will be set to "OFF" by default in the factory setting - administrators will have to manually and deliberately activate functions such as SNMP or remote syslog before they can be used.

Webserver

to increase security, the configuration by using SSH console is no longer allowed, the integrated web server is the only communication option for configuring the CS141.

Disabling HTTP will restart the device without starting the web interface. By disabling, no further configuration is possible. The CS141 therefore issues a direct alert before disabling this option. Ensure your configuration is done perfectly - Disabling the HTTP Server cannot be withdrawn without physical access to the device.

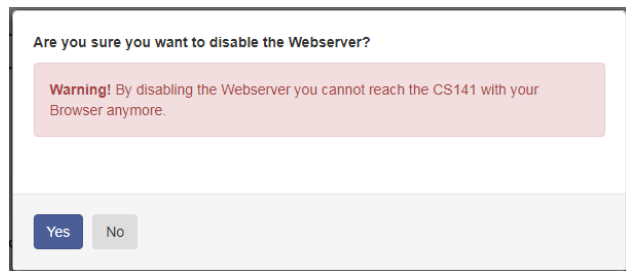

Why it is possible to deactivate this server?

In some cases, it is necessary to ensure a minimum of possible interactions. The CS141 takes care even in this seldom cases: Depending on its configuration only additional sftp-access is possible in order to download data logs. Therefore, the admin password can be known without consequences of network security.

Note:

The rescue system on the CS141 has not only saved the last firmware, but also the last configuration before your update. If you intend to deactivate the http functionality, it is recommended to perform a firmware update before this last configuration step:

By doing it, you will be able to access the system by its build-in rescue mode.

SNMP

The Simple Network Management Protocol (SNMP) is a network protocol developed by the IETF to monitor and control network elements from a central station.

The protocol controls the communication between the monitored devices and the monitoring station. Thereby SNMP describes the structure of the data packets that can be sent as well as the entire communication process.

It was designed to ensure any network-capable device can be implemented into monitoring systems.

Possible tasks of network management using SNMP include:

- monitoring of network components,
- Remote control and remote configuration of network components
- Error detection and error notification.

With its simplicity, modularity and versatility, SNMP has become the standard supported by most management programs as well as endpoints.

If you want to use SNMP in your network, leave the check mark active for this function.

Modbus

Fieldbuses are bus systems that connect field devices like sensors or actuators inside a complex operating scenario to allow communication to an according full-automated managing system.

If several communication partners send their information over the same line, it is necessary to ensure communication about fixed rules:

- who (identifier)
- what (measure, command) and
- when (initiative)

To ensure this communication, there are standardized protocols to be used.

Some historical facts:

The Modbus protocol was launched in 1979 by Gould-Modicon for communicating with its programmable logic controllers and has become an unofficial standard for industrial usage due to its open protocol standard. Since 1999, fieldbuses have been standardized worldwide in the IEC 61158 standard (Digital data communication for measurement and control - Fieldbus for use in industrial control systems). The second generation of fieldbus technology is based on real-time Ethernet.

For more information, please refer to the chapter "Modbus" in this manual. Modbus-tables are appended.

BACnet Server

BACnet (Building Automation and Control Networks) is a network protocol, standardized by ASHRAE, ANSI and ISO 16484-5 for building automation. For more information about the possibilities and configuration, please refer to the chapter "BACnet" in this manual.

Serial Trace

The tool box at System>Tools a CS141 provides offer beneath others a serial UPS tracer for visualizing and evaluation of communication problems between the CS141 and the UPS. However, this communication takes place via port 4000. With this slider, it is possible to selectively open (on) or close (off) port 4000.

UNMS & RCCMD Trap Service

The UNMS & RCCMD Trap Service was specially developed for communication with the universal network management software from GENEREX. The powerful successor UNMS 2 communicates with the CS141 via UPSTCP on port 5769. The UPS server service activates or deactivates the availability to communicate via this port.

RSyslog Client

Remote syslog is a popular method of sending locally stored log files in a standardized format to a central network node, called a syslog receiver, regardless of the device or manufacturer. This slider enables / disables the Remote syslog service.

BACS Viewer

If running a BACS system, you can use the BACS Viewer software to download the data from the batteries being monitored. This function opens the necessary SFTP port and enables the agent via which the BACS viewer can connect to the CS141 / BACS WEBMANAGER.

Date and time

For this configuration step, navigate to the following menu:

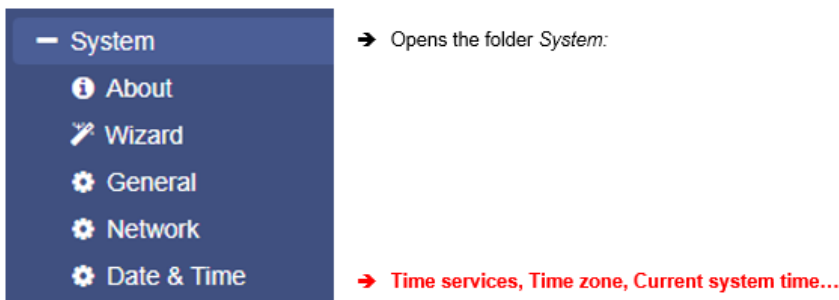

Surprisingly some system critical duties like logging or running recurring tasks require a reliable Realtime-clock. For this reason, the CS141 provides an own system clock but also offers the ability to query external NTP servers. For maximizing failure security, the CS141 can even set and read the internal clock of the UPS if supported.

Automatic time adjustment

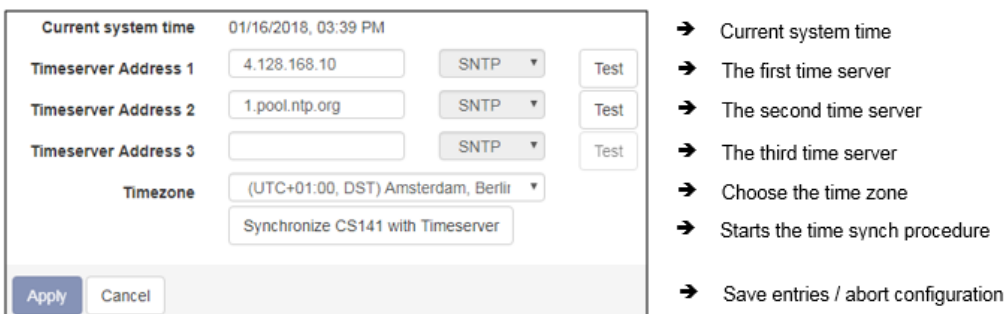

If the network settings are set correctly and CS141 gets an internet connection, you can use the default server settings. In case of a local time server inside a closed-up network segment, the CS141 provides to use an IP address instead of name services. If internal time services used, we recommend the option to enter an IP address although a DNS-Service is available:

If DNS lookup fails, the NTP synchronization will not run.

Note:

A time server normally provides preformatted time containing information about used time zones. The CS141 calculates the real system time itself from the time zone setting.

If you operate your own time server, this time zone must be adjusted accordingly.

Pressing Apply will save the settings and restarts the time server service inside the CS141 without rebooting. As soon as the time service accepted the new settings, the first-time synchronization follows.

Tutorial: How to set up a custom time server

In order to use a custom time server, a PC needs an NTP service.

Important:

Please note in case of using a Microsoft Windows operating system:

From professional Edition, Windows operating systems offer an integrated NTP service. Unfortunately, this internal NTP service provided by Microsoft Windows is not compatible for using with CS141.

Numerous freeware tools located on the Web, which can provide this service, too - therefore it is not necessary to use Microsoft's internal NTP service. These individual providers differ in the points

- User guidance
- Installation
- Pricing for additional features
- Supported Operating Systems
- ..

A well-made little tool is NTP for Windows, we exemplify in this manual. Due to the fact this is a freeware tool, the download source may differ after writing this manual.

Step 1: Download the tool from the Internet:
Possible download sources would be

The download area of the news service heise.de

<https://www.heise.de/download/product/ntp-fuer-windows-49605/download>

Meinberg, provider of this tool:

<https://www.meinberg.de/german/sw/ntp.htm>

Please note, download links may differ and even change after writing this manual. After download, the tool can be easily installed.

Step 2: Start the installation routine. The installer guides you through the complete installation:

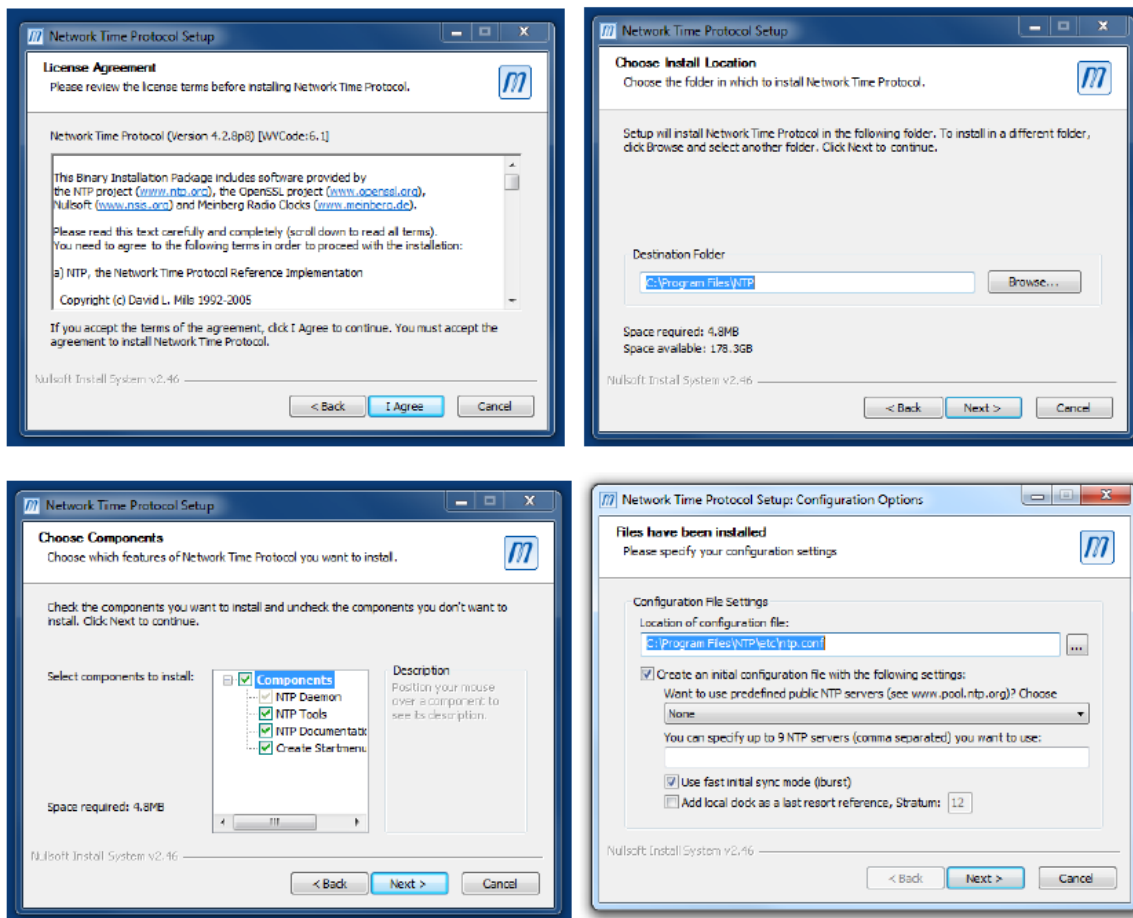

Please note that the features selected and working this example may not match your network. If you are not sure if these settings are correct or have trouble after installing, refer local system administrator team.

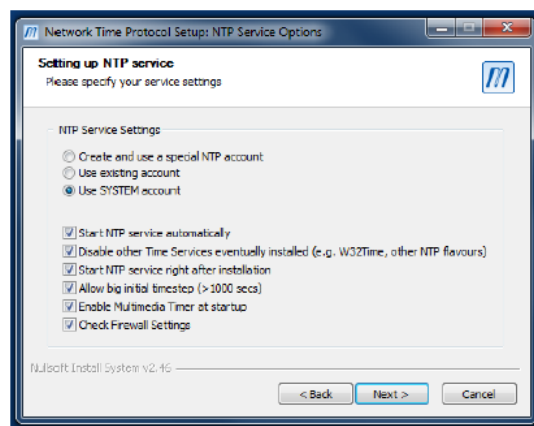

NTP Tool needs an account to provide time services – Normally you can use this option:

- Use SYSTEM Account

The tool asks to create a configuration file during installation. This is necessary for operation therefore you need to allow it - the tool will create and configure this file for you.

Note:

After installation, you should restart NTP for Windows using the option *Start as administrator*. Otherwise, it could cause problems during operation. If you are not authorized to use this option, please contact your local system administrator.

Testing the NTP server tool

If the NTP server has been started, you can check the functions with an NTP server testing tool. Download another freeware tool from the following website:

<http://www.ntp-time-server.com/ntp-server-tool.html>

Please note that this tool only returns correct values if the following 2 conditions are completed:

1. The computer with the NTP time server is in the same network segment like the computer containing the NTP testing tool.
2. You use a second computer for testing

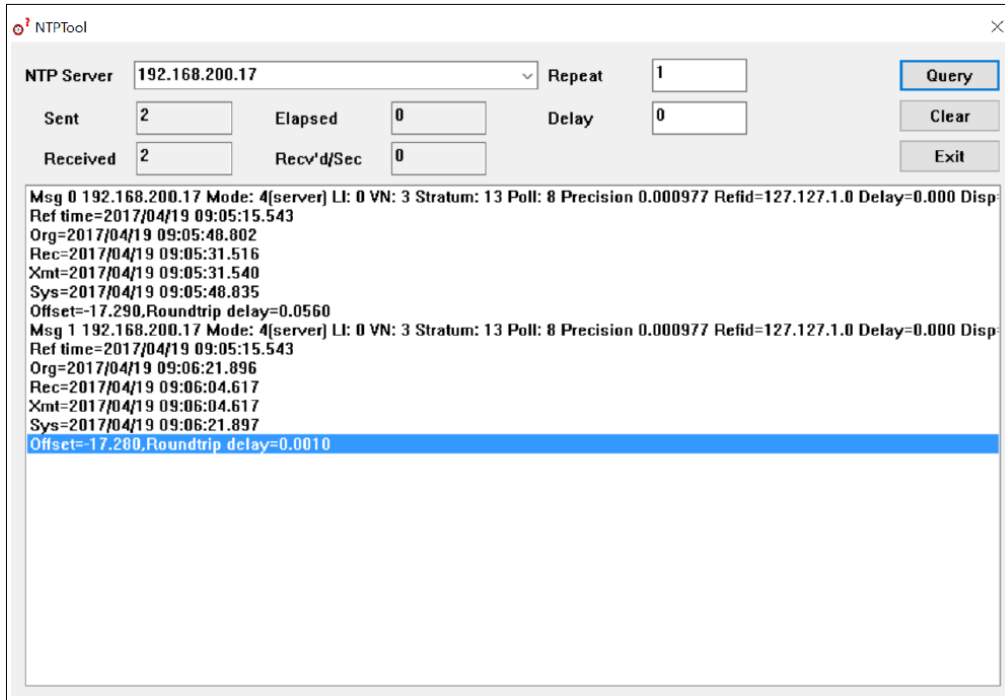

The NTP server in this example is installed on a Windows machine dealing with the IP 192.168.200.17, subnet mask 255.255.255.0. Both the test PC and the CS141 must therefore be located within the corresponding IP address space. Otherwise, the NTP server service will not work.

Set up time manually

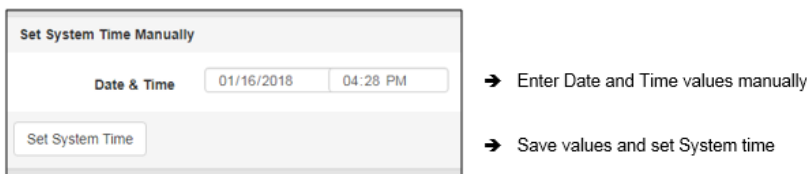

In some case it may be required to enter time manually. with pressing *Set System Time*, the CS141 will accept the new values and overwrite the current system time. The result can be seen instantly under *Current System Time*. To prevent automatic time correction, delete NTP Server. Please ensure the UPS does not correct it, too.

Note:

The synchronization with a time server is performed automatically by the operating system inside of the CS141 device. Therefore, you will not find it in event log files. "Device time synchronized" refers to a special function of the UPS and indicates the internal clock of the UPS has been readjusted by the CS141.

Exception:

You have changed the settings and restarted the NTP service using the Synchronize with Timeserver function.in this case, the according user interface subsystem recognizes a manually triggered execution and will insert a log entry.

User Management

For this configuration step, you need the following menu:

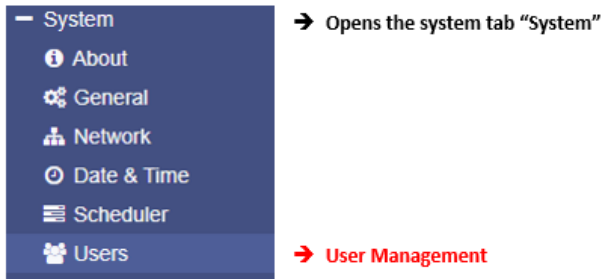

The user management of the CS14 allows a multi-layered adaptation to the respective security requirements of a network. Administrators can choose between 3 different basic strategies to decide as freely as possible whether and how the login should be possible:

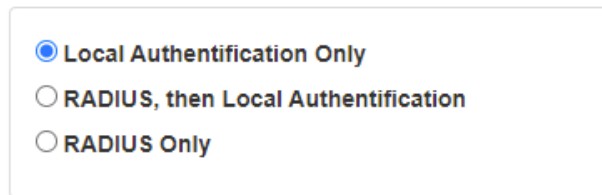

Local Authentication only

In this operating mode, the CS141 uses only the users configured on the respective unit. Changes must be made manually by an administrator or by the "Super User" on each single device.

RADIUS, then Local authentication

With this setup, a RADIUS server is asked first. If RADIUS is not available, the CS141 checks whether the requested user is known in the internal (local) user pool.

RADIUS Only

When operating with RADIUS Only mode, the CS141 will completely ignore the internal database - only users and passwords that are stored at the associated RADIUS server are valid.

Note:

The Super User "admin" comes with a special role

User: *admin*
Password: *cs141-snmip*

This is the only preset user that cannot be changed or locked up. Should there be widespread network malfunctions, the super user "admin" grants a logon that comes with additional tools for extensive network diagnostics. Ensure to choose a save password for this user!

If RADIUS ONLY mode is active, this user can be explicitly enabled by moving the slide switch to the centre position (configuration mode, IP is then 10.10.10.10 / 24) and restarting the CS141.

More detailed explanations and further options can be found in the chapter "Troubleshooting - if nothing works"

The internal (local) user management console

Lokale Nutzer			
+		Name	Role
		admin	Super User
		engineer	Engineer
		customer	Customer
		guest	Guest

With the internal (local) user administration, user names, passwords and administrative levels are directly specified by administrators within the respective CS141. Except for the super user "admin", it is possible to define freely user name as well as the user role.

Note:

Name versus Role - what is the difference?

The CS141 distinguishes between the user name / password and a pre-configured user role. The user role decides which menus are displayed to the user's name created by an administrator: For example, it is not relevant for a technician to be allowed changing settings on the mail server or the IP address. In order to avoid misconfiguration, these menus are completely hidden for the corresponding user role "Engineer" and therefore blocked for the technician.

Preset Users

The preset users grant a quick start. They can be adapted to the respective operating scenario as required.

Der Super User „admin“

User admin
Default Password: cs141-snmp

This user is unique and cannot be deleted or deactivated. Users with this clearance level not only have administrative access, but also receive valuable diagnostic tools for extensive network analyses. The super user admin is also the only user with absolute password control

The Engineer

User engineer
Default Password: engineer

The technician has a user account restricted to his area of responsibility. He has access to the functions that concern technical action. He has the ability to carry out an initial configuration of available devices, as well take over advanced technical settings.

The Customer

User customer
Default Password: customer

The customer has access to the system monitors and can also view and download the collected log files. The administrative functions with which the data can be deleted, among other things, are not accessible.

Guest access

User guest
Default Password: guest

The guest access enables pure viewing of the system monitors without being allowed to trigger further functions. The special feature of this user is that the password query can be deactivated if required.

Locking user release levels

This menu allows you to deny access to certain user groups (user roles) across the board.

- Lock the Engineer Role
- Lock the Customer Role
- Lock the Guest Role

Note: Cybersecurity Enhanced Default Settings

Using standard users and passwords are always pretty dangerous because they are well-known to be found within a user's guide. For this reason, all user profiles are generally locked by factory setting, and must be exclusively released by an administrator. Available options to administrators for securing their devices are described in detail in the CS141 Hardening Guide section.

Special function: Allow user profile "Anonymous Guests"

To use the guest access without a password, set a check mark at Anonymous authentication. This function can be used by a higher-level monitoring software such as GENEREX's UNMS II, e.g., to display necessary data for monitoring without a password request.

Optional user role: The „Administrator“

+		Name	Role
		admin	Super User
		Montgomery Scott	Administrator
		engineer	Engineer
		customer	Customer

The administrator can be set up exclusively by a super user. The "administrator" then offers a slightly graded version of the super user - it has far-reaching system rights and can perform all the day-to-day tasks of an administrator.

In contrast to the Super User "admin", the Administrator can be managed by a RADIUS server.

Note:

A RADIUS user role "administrator" cannot be called "admin" like the super user - the CS141 will reject this login constellation on principle to avoid confusion between users and user roles.

How to use guest /anonymous login

The guest access can be used for

Normally, the CS141 only provides information via its web interface if a user successfully logs in - a deep link to view the UPS monitor directly is treated accordingly:

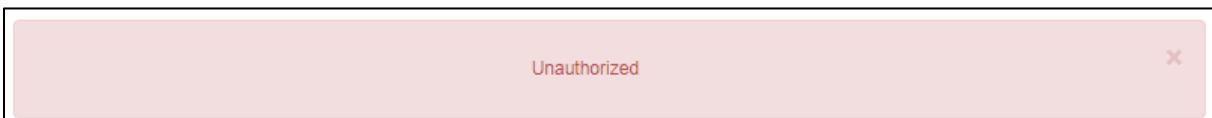

After activating Anonymous authentication, it is possible to view the monitoring screens directly – it is even possible to create a small html page and set up an I-frame to show it inside larger websites or content management systems. This html code may help you to create the html website:

```
<html><head></head>
<body>
<center>
<p>I-Frame zu der USV mit der IP xxx </p>
<br><hr><br>
<iframe src="http://<Ihre IP>/www/devices/ups/page" height="600" width="850" name="iFrame" title="IFrame zu meiner USV"></iframe>
</center>
</body></html>
```

As a result, the UPS monitoring screen will appear inside your html document:

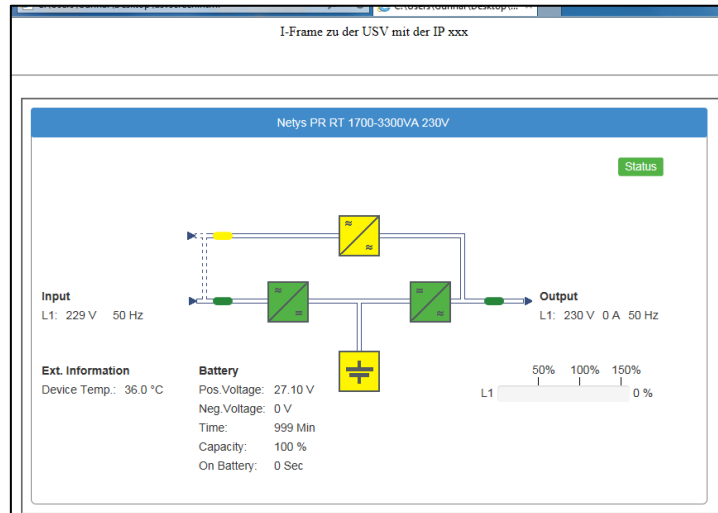

Possible deep links:

http://10.10.10.10/www/devices/ups/page	Opens the UPS monitoring screen
http://10.10.10.10/www/devices/sensor/page	Opens the Sensor monitoring screen
http://10.10.10.10/www/devices/bacs/page	Opens the BACS monitoring screen.

Note:

By using the web query directly, you will notice the URL inside your web browser will change. This is because you start a page request, but the web server on the CS141 responds with a different page and will redirect you automatically: Since the page behavior is dynamically, the response page may change accordingly. However, the HTML request is standardized with these three deep links and will be served as long as the Anonymous login is active.

Create, delete and edit local users ...

Add a user...

To open the configuration dialogue for creating users, click under "Local users" on . Then simply create the user and specify the user role:

Add User

Name	<input type="text" value="User Name"/>	→	Enter a user name in freeform
Role	<input style="border: 1px solid #add8e6;" type="text" value="Administrator"/>	→	Select the user role for this user
Password	<input type="text" value="Password"/>	→	Enter a password
Verify Password	<input type="text" value="Confirm Password"/>	→	Repeat the password
	<input type="checkbox"/> Show password		

→ Save settings and close this dialogue
→ Cancel settings and withdraw

At "User Name", it is possible to freely type any user:

- James T, Kirk
- Joardy La'Forge
- User_%&}\annmaP

However, the CS141 will obey the exact spelling including upper/lower case and spaces.

Edit a user ...

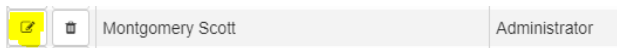

Click on the edit- symbol to open the according menu:

Edit User

Name	<input type="text" value="James T. Kirk"/>	→ Change the user's name
Role	<input type="text" value="Administrator"/>	→ Change the user's role
New Password	<input type="password" value="*****"/>	→ Change the current user password
Verify Password	<input type="password" value="*****"/>	→ Repeat the new user password
<input type="checkbox"/> Show password		

→ Save settings and close this dialogue

→ Cancel settings and withdraw

The user will be changed on the fly. If the user is logged in for the moment, the new settings are active on reboot or logout.

Delete a user ...

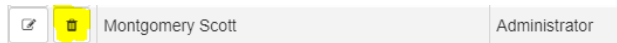

To delete a user, simply click on the recycle bin next to the user. If you delete the user, you are currently using, your username will become invalid when you log out.

The RADIUS – Server

Firmware 2.02 or higher is required for this function. The necessary firmware update can be downloaded free of charge at www.generex.de. This function is available directly after the firmware update.

What is „RADIUS“ ?

RADIUS is the abbreviation for **R**emote **A**uthentication **D**ial-In **U**ser **S**ervice. In principle, the point is that with a growing number of end devices such as printers, access points, switches, routers, etc. in conjunction with more and more staff that dynamically access the configuration menus, someday the point is reached where the time required for setting up, deleting and re-encrypting users becomes time intensive ... With a functioning RADIUS, one can centralize the necessary approvals and no longer have to maintain users and their approvals locally on the respective end devices.

Roughly speaking, it works like this:

The end device is informed of "its" RADIUS server, where it can ask whether a user exists and which authorization a requested user holds within the network. The RADIUS server accepts the request, compares its user database and responds accordingly. As a result, an end device does not have to maintain its own user database, which of course also has to be maintained exclusively in case of staff or passwords change.

A little more practical:

Imagine the following work order:

15 access points from different manufacturers, on which 3 users must be decrypted, 2 users receive other approvals and 1 user is added. For the administrator, this means that he has to handle 15*6 users, i.e., he has to change a total of 90 user data, has to log in exclusively to each end device, and thus, in the worst case, needs 15 passwords and has to choose between "admin", "administrator", "root", etc... An immense effort that arises for just 6 users.

With a RADIUS server, there are ultimately only 6 users, which are also stored centrally. In this case, the end devices do not have to be touched at all, as they ask the RADIUS server who is allowed to log in.

From a certain network size / number of end devices and staff strength onward, it makes sense to consider using RADIUS servers.

Configuring a CS141 to use a RADIUS serverNecessary prerequisites:

1. A RADIUS-Server that is running
2. Access data and, if applicable, certificates
3. Network connection for the CS141 and local administrative access (Super User or "Administrator")

Step 1 – Configure a Radius-Server

For this configuration tutorial, we use the FreeRADIUS for Windows, as it is relatively easy to set up and is quickly ready for operation even for inexperienced users. For more in-depth configurations and the RADIUS server you use, please contact the corresponding technical support for your product. The FreeRADIUS for Windows is available via download from the Internet (e.g., visit Sourceforge for a downloadlink).

Setting up a RADIUS user at the server:

In this configuration, we assume that the IP address is well-known, and the RADIUS server is installed in the following directory:

C:\FreeRADIUS.net

In this directory, you will find the *.exe -file to start the RADIUS server ...

Please ensure both, to install and to run this program „as administrator“, otherwise you may run into problems when running the server program.

The necessary configuration files can all be found in the following directory:

C:\FreeRADIUS.net\etc\raddb

Here, the file "users.conf" is particularly interesting.

For best use, I recommend a good code editor like Notepad 2+, Sublime or something like that, they work very well:

Two users have been entered in this example. The following specifications currently apply to the CS141:

Administrative-User

This is the local CS141 user role „Administrator“.

Login-User

This is the local CS141 user role „Engineer“.

```
##### RFC3580 #####
## Also the "eap.conf" MUST be modified to include the follow line:
## "use_tunneled_reply = yes"
## the default is "use_tunneled_reply = no"
## this allow the "Tunnel*" AV's to be passed outside the eap tunnel
## otherwise the switch will NOT see the VLAN to place the port into
#### Comments added by Jeff Reilly ####

testuser  User-Password == "testpw"

HansWurst User-Password == "Bitte_MitSenf&$1"
          Service-Type = Administrative-User,

Hansi User-Password == "Hansi1234&5"
          Service-Type = Login-User,

FreeRADIUS.net-Client  User-Password == "demo"

rfc3580 User-Password == "demo"
        Tunnel-Type = "VLAN",
        Tunnel-Medium-Type = "IEEE-802",
        Tunnel-Private-Group-Id = "1",
        Reply-Message = "Hello, %u"
```

Customer, Guest, etc. are currently not supported, they will be added with the next firmware updates.

Note:

Feel free to add as many uses as you want – it is your RADIUS server.

Furthermore, this may be nice to know:

The machine account for the CS141:

This is the account that the CS141 needs when it wants to log on to the RADIUS server. Without this account, the CS141 will not be able to ask the RADIUS server for custom users - the RADIUS server will drop the query without a reason.

However, this account is also specified in the file "users.conf". In this example, the user's name and password with which the CS141 logs on to the RADIUS server is called:

- User: FreeRADIUS.net-Client
- Password: demo

```
testuser  User-Password == "testpw"

HansWurst User-Password == "Bitte_MitSenf&$1"
          Service-Type = Administrative-User,

Hansi User-Password == "Hansi1234&5"
          Service-Type = Login-User,

FreeRADIUS.net-Client  User-Password == "demo"

rfc3580 User-Password == "demo"
        Tunnel-Type = "VLAN",
        Tunnel-Medium-Type = "IEEE-802",
        Tunnel-Private-Group-Id = "1",
        Reply-Message = "Hello, %u"
```

The Pre-Shared Key (Shared Secret at the CS141)

In addition, the CS141 will ask for a "pre-shared key", which can be found in the file "clients.conf":

In this case the pre-shared key is

"testing456"

And is valid for the network 192.168.150.0/24 - You may have to adapt this setting to fit to your network. Why you need this configuration: Only if the CS141 first transmits this key before the request, the RADIUS server will feel compelled to process this request. In all other cases, the RADIUS server will simply drop this request.

From now, you have all the information needed for the configuration of the CS141.

```
# You can now specify one secret for a network of clients.
# When a client request comes in, the BEST match is chosen.
# i.e. The entry from the smallest possible network.
#
#client 192.168.0.0/24 {
#   secret      = testing123-1
#   shortname   = private-network-1
#}
#
client 192.168.0.0/16 {
  secret      = testing123
  shortname   = private-network-1
}

client 172.16.0.0/16 {
  secret      = testing123
  shortname   = private-network-2
}

client 10.0.0.0/8 {
  secret      = testing123
  shortname   = private-network-3
}
client 192.168.222.0/24 {
  secret      = testing456
  shortname   = private-network-4
}
```

Note:

After each configuration work, do not forget to restart the RADIUS server, otherwise the new configurations will not be available.

The "Debug-Mode":

Before configuring the CS141, ensure that the RADIUS server is correctly configured and started, it can easily be done via the context menu of the RADIUS icon on the taskbar. Start, Stop, Debug mode, etc. are clearly and direct accessible.

The debug mode comes with a special feature:

On start, a CMD window opens in which the RADIUS server shows what it is currently doing and - very interesting - why a request was rejected:

```
C:\WINDOWS\system32\cmd.exe
rlm_counter: Counter attribute Daily-Session-Time is number 1830
rlm_counter: Current Time: 1630077552 [2021-08-27 17:19:12], Next reset 1630101600 [2021-08-28 00:00:00]
Module: Instantiated counter (daily)
Module: Loaded radutmp
radutmp: filename = "../var/log/radius/radutmp"
radutmp: username = "%{User-Name}"
radutmp: case_sensitive = yes
radutmp: check_with_nas = yes
radutmp: perm = 511
radutmp: callerid = yes
Module: Instantiated radutmp (radutmp)
detail: detailfile = "../var/log/radius/radacct/{Client-IP-Address}/pre-proxy-detail-%Y%m%d.log"
detail: detailperm = 511
detail: dirperm = 493
detail: locking = no
Module: Instantiated detail (pre_proxy_log)
detail: detailfile = "../var/log/radius/radacct/{Client-IP-Address}/post-proxy-detail-%Y%m%d.log"
detail: detailperm = 511
detail: dirperm = 493
detail: locking = no
Module: Instantiated detail (post_proxy_log)
detail: detailfile = "../var/log/radius/radacct/{Client-IP-Address}/reply-detail-%Y%m%d.log"
detail: detailperm = 511
detail: dirperm = 493
detail: locking = no
Module: Instantiated detail (reply_log)
Listening on authentication *:1812
Listening on accounting *:1813
Ready to process requests.
```

At the end of the start routine, it says "Ready to process requests":

- If the window closes again immediately, then something is wrong in the RADIUS server, probably something is wrong in the entries you made yourself.

- In any other case, in this window whether and how the test setup serve RADIUS requests.

- To stop the RADIUS server, simply close the debug window and the RADIUS server is "OFF" until the next start, which is very practical for quick test runs.

Typical Test Setup for a RADIUS Server

Before we set up the CS141, we should consider how the RADIUS server is to be addressed in the first place:

With the settings made, you can already run a RADIUS server on any PC for test purposes.

If you look at the screenshot above in the section "Preshared Key" again, you will find the following entry (If this is not included, please add it, make sure that the private network has a sequential number

```
client 10.0.0.0 / 8 {
    secret = testing123
    shortname = private-network 3
}
```

So in this case, the IP address range 10.10.10.0 - 10.10.10.254 is included in the RADIUS - pool, and the RADIUS server will answer in any case if the computer and the CS141 have a matching IP address.

In this tutorial, you will assign the IP address 10.10.10.12 / 255.255.255.0 to the network adapter of your computer. 1.

1. as soon as you connect a CS141, it is directly accessible in configuration mode (slide switch in the middle) and during the initial setup via the start IP 10.10.10.10.
2. As soon as you set up the RADIUS function on the CS141, the CS141 will send the request to the IP 10.10.10.12 and the RADIUS server will respond accordingly.

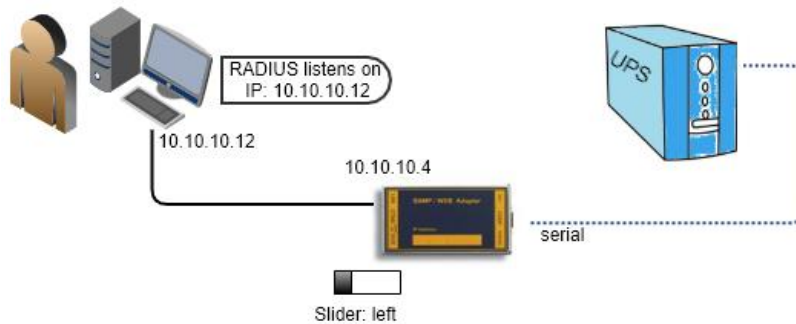

Before proceeding to step 2, make sure that

- the slide switch is in the left position
- the IP address is set to 10.10.10.4.
- Your PC to the IP address 10.10.10.12.
- The RADIUS server is running in debug mode to see what is happening.

Step 2: Setting up the RADIUS Client

When the RADIUS server is running, it will be possible to configure and test the CS141

At RADIUS Servers, click the edit - symbol to open the configuration dialogue. The CS141 supports up to two RADIUS servers, which are queried one after the other.

RADIUS Servers		
	Priority	IP-Adresse
<input checked="" type="checkbox"/>	Primary	127.0.0.1
<input checked="" type="checkbox"/>	Secondary	127.0.0.1

IP address, Port and Shared Secret

IP address	127.0.0.1
Port	1812
Shared Secret	Shared Secret
	<input type="checkbox"/> Show Shared Secret

- ➔ IP address of the RADIUS-Server
- ➔ The Port the RADIUS-Server is listening
- ➔ The pre-shared key of the RADIS server.

- IP address: Enter the valid IP address of the RADIUS server.
- Port: Enter the port on which your RADIUS server is currently listening.
- Shared Key: This key is used to authenticate the response of the RADIUS server - without this key, the server drops a request on principle.

Select your encryption method

Encryption has become a technical standard within modern networks. The CS141 therefore supports numerous encryption methods and can thus be adapted to the most diverse requirements within the network infrastructure. Please note that you may need additional certificates and do more configuration work that this example configuration describes.

Use TLS Connection	<input checked="" type="checkbox"/>
EAP Types/Methods	TTLS
Authentication Method	PAP

If you plan other encryption methods, please refer to the local responsible system administrator.

Setting up Timeouts and Retries

The timeout is set in seconds and defines how long the CS141 waits until it considers the request is lost. The default value is 30 seconds.

Timeout[s]	30
Authentication Retries	1

With the Retries, it is possible to set how often the request should be repeated before the CS141 finally gives up and asks the second RADIUS server.

Please note that timeout and retries are working together may lead to users waiting a very long time for a response in case of RADIUS is not accessible.

The Radius Client User / the machine account

In order to be able to communicate with the RADIUS server, the CS141 requires its own valid account, via which the CS141 can connect to the RADIUS server to ask for valid user IDs.

For valid login data, please refer to the responsible system administrator.

Test the RADIUS Server Configuration.

Please note: You can save the changes only if the test was successful.

User

Password

Show Password

Test, Save and Cancel

Entries can only be saved after all data has been entered correctly and the connection test to the RADIUS server has been successful.

Test

Save

Cancel

Step 3: Handing over the login control

1. Switch from Local Authentication Only to RADIUS, then Local Authentication:

Local Authentication Only

RADIUS, then Local Authentication

RADIUS Only

2. And press "apply".

From now, you will be able to test your RADIUS configuration. If something is wrong, the local Super User "admin" is still active and available. If something is wrong, just disable the RADIUS server for this CS141.

RADIUS with Microsoft NPS and Cisco ISE

Admittedly, this guide goes into a lot of detail about FreeRADIUS, which won't help you much with Microsoft NPS or Cisco ISE, ...

The difference between Microsoft NPS / Cisco ISE and Freeradius is as follows:

In FreeRADIUS, the user role is stored as a STRING, whereas both the Microsoft NPS and the Cisco ISE work with the INTEGER:

CS141 Rolle	Service-Type (Numerisch)	Service-Type (Name)
Administrator	6	Administrative (Administrative-User)
Engineer	1	Login (Login-User)
Guest	?	?

RADIUS 802.1X

The basic principle

Normally, there is a network-compatible device on one side that wants to log on to a network. It does not matter whether this is done via WLAN or "cable". As soon as the connection is established, the device either asks for an IP address from the network or logs on directly with a manually assigned (static) IP address.

However, with an active Port Access Entity, or PAE for short, this is not so "straightforward", as the access requirements are changed:

A special port to the network is opened exclusively for a network-compatible device (the "Sublicant") if the device can prove its right to exist in the network. The router does not decide this itself, but forwards the sublicant's request to a responsible authority. In its function as an "authenticator", the router first clarifies whether the requesting device is allowed to access the network at all:

A supplicant needs permission from the responsible server to enter the network at all, and only if the according server agrees will a port be opened for the client, through which it can then use the network for further communication.

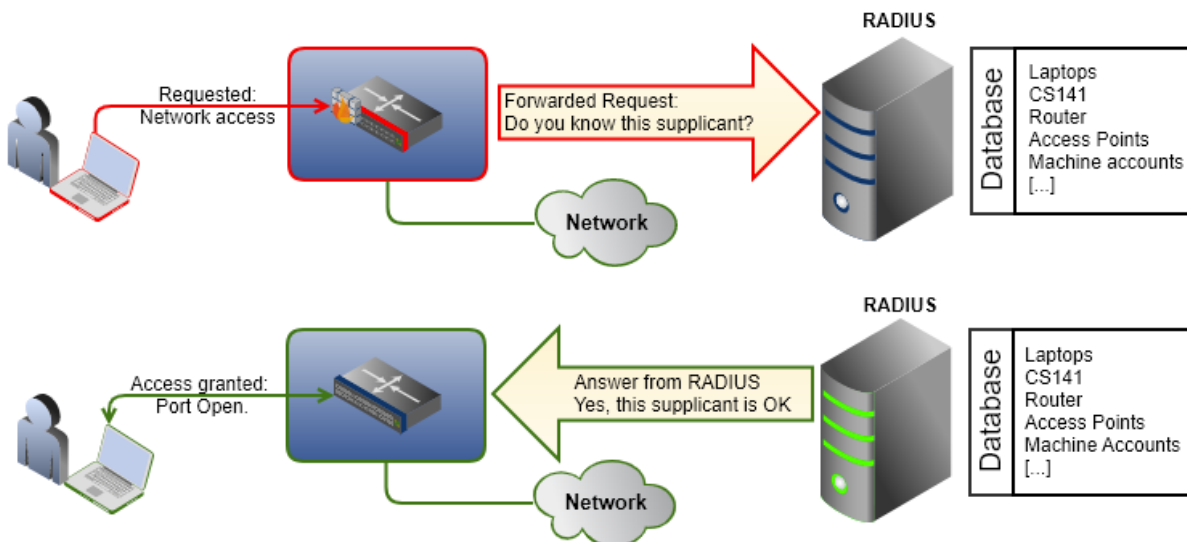

In this way, one ensures in the first instance from a central location - in this case a RADIUS server - that only devices that are also authorized by the administrator have access to a LAN.

Confinguration of the 802.1X Support

*For this configuration step, please update to **firmware version 2.06 or higher**. You need the following menu item:*

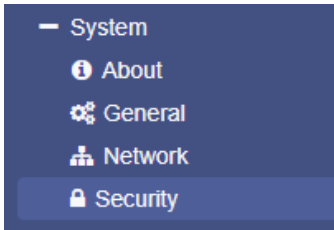

→ Opens the Tab "System"

→ Configure 802.1X Support

Additional documentation:

- Chapter „The RADIUS server“, within this document: -> [CLICK HERE](#) <-
In this chapter we explain how to set up a basic RADIUS test server and use it to test the functions of the CS141.
- Technical documentation of Switches / Routers used for 802.1x

In addition to a RADIUS server, the operation of EAP requires the use of specially configured hardware. The configuration instructions can be found in the documentation of the respective device.

Setting up CS141 for 802.1x

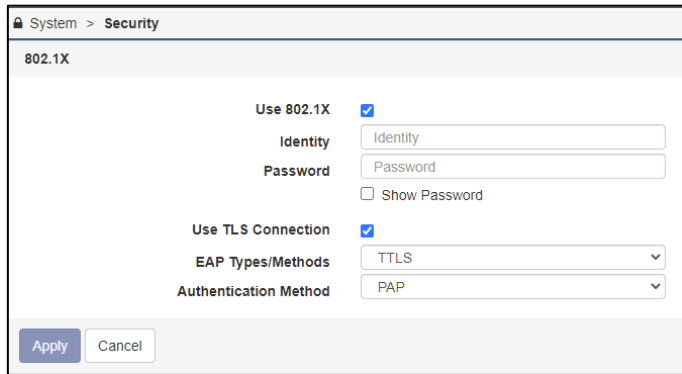

- Enable / Disable 802.1X
- User and Password as configured within the RADIUS Server
- Show / Hide Password
- Enable / Disable encryption
- Choose the encryption method

The CS141 uses a machine account to log on to the network as a sublicant. Depending on the network, an encryption method can also be selected to increase communication between all participants.

Note:

Which encryption method you need to use, depends largely on your network - this information can be obtained from the administrator responsible for your network

The release level as a guest is already completely sufficient:

```

98 Trinity User-Password == "cs161-sntp"
99     Service-Type = Login-User,
100
101 Armageddon User-Password == "cs161-sntp"
102     Service-Type = Administrative-User,
103
104
105 #Rainer_Zufall User-Password == "Trifft_immer"
106 #     Service-Type = Administrative-User,
107
108
109 CS141-Client User-Password == "demo"
110
111 rfc3580 User-Password == "demo"
112     Tunnel-Type = "VLAN",
113     Tunnel-Medium-Type = "IEEE-802",
114     Tunnel-Private-Group-Id = "1",
115     Reply-Message = "Hello, %u"
116
117 #
    
```

What does this setting have to do with the RADIUS settings within the menu "Users"?

In Short: Nothing.

802.1X is an independent function with which you can generally define the access of the device to a network. Therefore, you do not have to grant administrative access to the CS141 as shown above, it is sufficient that the CS141 is generally authorized to use a port for 802.1X:

By doing so, it is possible configuring the device in order to meet the requirements

- a. Use General access limitation via RADIUS 802.1X port access.
- b. Running the CS141 with only locally configured user restrictions.
- c. Running with RADIUS users only
- d. Running generally RADIUS users only but using local users in case of no RADIUS is available

Detailed configuration instructions for the RADIUS server can be found in the chapter "RADIUS server" in this manual.

Advanced system overview

For this configuration step, navigate to the following menu:

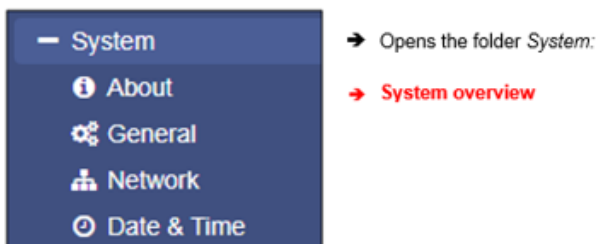

After completing all basic settings, the advanced system overview will list available information about your CS14. The system overview is divided into several sections:

System overview

Name	CS141SC	→ CS 141 Webmanager version
Version	CS141-SNMP V1.68.12 180319	→ Current firmware
License	Pro Edition	→ Used license key
Manufacturer	Generex	→ OEM-manufacturer
UPS Model	No UPS model defined	→ Configured UPS
Location		→ Location of the device
Time	2000-01-01 01:44:44 (UTC) Coordinated Universal Time	→ Current system time and used time zone
Uptime	0 days, 0 hours, 6 minutes, 55 seconds	→ Uptime since last reboot

If there are questions or some issues during installation, our technical support will help as fast as possible. Please note, our support needs at least following information:

- Firmware
- UPS model and type
- Uptime since last reboot

Network settings

Network	
MAC Address	00-30-d6-14-21-3c
IP Address	192.168.200.113
Subnet Mask	255.255.255.0
Gateway	192.168.200.1
DNS Server	192.168.200.3

- MAC-Address of yourCS141
- Configured IP Address
- Configured Subnet Mask
- Configured Gateway
- Configured DNS-Server

The network settings show the current configuration:

- MAC address:** The Media Access Control is a worldwide unique address to identify a network device. This address is given by the manufacturer and cannot be changed.
- IP-Address:** Shows current IP address assigned to this device. In configuration mode, the default IP 10.10.10.10 is set, even if the IP address configured by administrators differs.
- Gateway:** Defines the network device that is allowed to accept and serve requests to the Internet. By default, the configuration mode uses IP 10.10.10.1
- DNS** The DNS server provides the translation of names and IP addresses into reachable destinations within networks. In configuration mode, it is the IP 10.10.10.1

Connectivity

Connectivity	
Devices	UPS
Services	Webserver, UNMS Server, SNMP Agent, Modbus Slave, Pipe Through

- Devices according to COM 1
- Services this CS141 device provides



Connectivity allows a general overview of the options the CS141 currently provides.

Devices thereby merely indicates a UPS can be connected hardwarely to the CS141, but not the kind of model. Services define the software-related services installed and started on the CS141 to communicate with additional devices as well as software.

Switch to operating mode

After completing basic configurations, move the slider to the desired position or set the DIP switches accordingly to enable regular operating mode. After reboot, the device will run in desired mode. if necessary, the device can fall back to configuration mode by setting DIP Switches or sliding switch into configuration mode. Note that the current switch position will generally take effect after rebooting CS141.

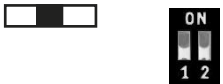
The table below shows the regular operation modes available to the CS141 family.

<p>Sliding switch to center position / DIP switch 1+2 OFF:</p> <p>After booting, the CS141 will run in configuration mode. Hard-coded default IP address 10.10.10.10 is active.</p>	
<p>Sliding switch to right position/ DIP 1 OFF + DIP 2 ON:</p> <p>After booting DHCP is active and IP address will be assigned automatically. To identify assigned IP address check MAC address of CS 141.</p>	
<p>Sliding switch to left position / DIP 1 to ON + DIP 2 OFF:</p> <p>After booting, manually configured network settings will take effect.</p>	

In general, there are three different options to restart the device:Option 1 – the cold boot

Briefly disconnect power by pulling the power plug or removing the card from the slot. The device will then boot to the appropriate operating state with the new hardware setting.

Option 2 - Reboot by software

For this step, please switch to the following menu:

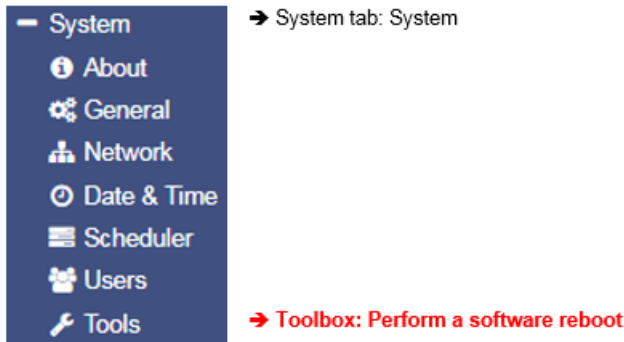

The toolbox is restricted for administration usage only.

After login as hard-coded user admin using default password cs141-snmp, you will be allowed to use the toolbox with extended support features. Please note: The default password is only active in case of no other password was set.

Afterwards it is possible to use the CS141 reboot option.

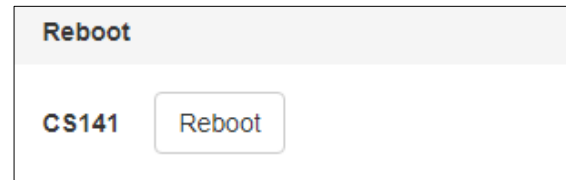

In both cases the UPS will not be restarted, but it only affects the CS141 - your power supply is ensured.

Option 3 (CS141HW161 only)

With 2022 onwards, the Slot Cards of the CS141HW161 introduced a Reset button:

- CS141HW161 SC
- CS141HW161 SCM
- CS141HW161 BSC
- CS141HW161 MINI / R2

To restart these Webmanager modules just push the reset button – this will not delete your current saved configuration, it will reboot the WEBMANAGER directly:

- Put the sliding switch into the position of the intended operation mode
- Press the Reset Button

The CS141HW161 will reboot and take over your desired hardware setting.

System notifications

Setting up email services

For this configuration step, navigate to the following menu:



The CS141 provides a variety of options to interact with the environment, external devices, and the network itself.

For this, the necessary services must be configured.

One basic feature is the automatic notification via email and email traps. Due to the fact the CS141 does not provide a complete mail server, a valid email account must be configured.

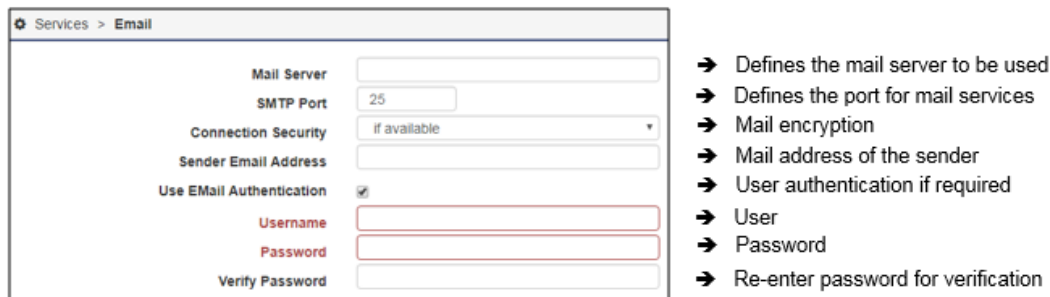

Mail server

Enter the mail server to be used.

To ensure a maximum of flexibility, the CS141 allows an appropriate IP address as well as an URL of external mail provider. Administrators can choose between additional external provider or use own mail servers.

Note:

The fact, your CS141 has a connection to the Internet to access external accounts of large mail providers does not mean an external provider will allow a usage for free. Sometimes they start to block service mails without stating reasons or failure message. It just stops working. In this case, it may be necessary to switch to another provider.

SMTP Port

Defines the port used by a mail client to communicate with the mail server. Basically, the ports are standardized. In some cases, administrators need to choose own ports configurations to ensure communication; The necessary access data must be obtained from the local administrator.

Connection Security

Select the encryption type used by the CS141 for sending the emails:

None	no encryption required
If available	STARTTLS
Force encryption	SSL / TLS

Sender Email Address

Enter the mail address to be shown as sender

Email authentication – user and password

Depending on its configuration, email servers either use the e-mail address as their username or their own user ID and password to receive e-mails.

For the valid access data, please contact the local network supervisor.

Advanced Error Log Options

The CS141 offers the possibility to send mail traffic as a blind carbon copy, too.

For some cases, this facilitates the analysis for example, if the sequence of an event has to be examined. With this menu, administrators may specify:

- What else should be sent
- The format to be use
- When it should be sent

- Select the mail format
- Logging email traffic
- Additional blind carbon copy mail job
- Blind carbon copy receiving mail address

Format

In some cases, mails will be stored by using database systems. This option enables sending mails compatible formatted.

Log

This setting toggles the conditions whether a sent mail will be registered by event log. Administrators can choose:

- Errors only* Mails that indicate errors are recorded in the event log
- Always* Each mail is recorded as "sent" in the event log
- Never* The mails are sent but not recorded in the event log.

Note:

Under circumstances, automatically sending a copy for all emails may cause a flood of messages - each message will be sent as a copy again.

You may find a similar problem with logging the complete email traffic:

Too many entries in the event log quickly lead to confusing data as soon as you search for special entries within a time window.

With Apply, the settings are transferred to the configuration and the service for sending mails is restarted.

Test mail settings

This function will be available after successful saving mail configuration. It allows to send a test mail to any valid mail address to test the connectivity:

- Open/Close Test Email Settings
- Receiver der Mail
- Subject
- Text body of the mail.

With the test fuction, the CS141 will send an Email to a mail receiver of your choice. By doing so, it is possible to test both: Sender and Receiver of a Mail Job.

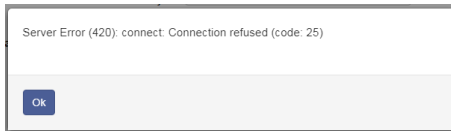
Mail error message**Connection refused**

This error indicates CS141 cannot establish a connection to the mail server it is configured to.

The reasons for this behavior can vary. some reasons may be:

- wrong encryption type
- wrong or closed ports
- DNS / Gateway settings are wrong

... or the fact, a mail provider does not allow this kind of mail traffic.

Problems with the mail server?

If you use your own mail server, you can usually take look at the incoming mail log. In general, the reason for rejecting an e-mail is also mentioned there. For online providers, however, the situation looks different:

You usually have no influence on the server and also no insight into the mail log.

As a result, you do everything right, but it still does not work and you cannot figure out why....

There are a couple of reasons, here are some examples:

1. The provider prohibits such service mails. The server simply rejects them automatically.
2. The mailing account must be confirmed manually. The email from unknown recources will be rejected until the user of the account validates the according sending device.
3. The frequency of mail is interpreted as spam. Mail providers react very fast and deny mails from this device even if they allow it in general.
4. Access data are basically correct but the mail server's virus guard is the opponion, the mail is used as a virus carrier. Depending on the settings of the server, the behavior may differ.

Note:

Basically, the CS141 also supports the Office365 mail server - be sure to use the correct port and encryption method!

SMTP: Server: SMTP.office365.com / Port: 587 / Encryption: STARTTLS

IMAP: Server: Outlook.office365.com / Port: 993 / Encryption: SSL / TLS

POP: Server: Outlook.office365.com / Port: 995 / Encryption: SSL / TLS

Tutorial: Setting up the mail notifications for a UPS event

After you have set up the e-mail client, you must tell the CS141 when it should send you an e-mail. To do this, open the events menu under Devices>UPS:

Devices > UPS > Events		Event	Jobs
>	<input type="checkbox"/>	contains...	contains...
>	<input type="checkbox"/>	Powerfail	3 1
>	<input type="checkbox"/>	Power restored	3 1
>	<input type="checkbox"/>	System shutdown	1 1
>	<input type="checkbox"/>	UPSMAN started	1 1
>	<input type="checkbox"/>	UPS connection lost	3 1
>	<input type="checkbox"/>	UPS connection restored	3 1
>	<input type="checkbox"/>	UPS Battery Old	1 1

All possible system events for the selected UPS model are listed within the system events overview - from here, it is possible to define what should happen if a certain event occurs. If you want to receive an e-mail for the event "Power failure", click on + to add the corresponding job. At the drop-down menu, select the job "E-mail" to get the according job dialogue.

Job E-Mail ▾

Parameter

Receiver user@domain.tld

Subject Powerfall

Text Message

Insert System Variables Input voltage L1 in V ▾ insert

Eventlog

Datalog

Receiver

Under Receiver, define, who should receive a mail. The CS141 also provides several addressees, separated by a comma:

Scotty@enginroom.intra,McCoy@sickbay.intra, kirk@...

Subject

Enter a subject that will later appear in your mail programme as may subject.

Text

This is a free form text field. Feel free to type anything that may be important for this mail, e.g. a code block for filtering functions, references to further documentation, important telephone numbers, location information, security guidelines (e.g. gas, acid, etc.), access controls, etc.

Insert System Variables

System variables are so-called "wildcards" that are replaced in the mail by the currently available values. With this option, it is possible to place the most relevant and latest measurement data in one mail that may help technical staff with evaluation of the incident.

Eventlog / Datalog

If desired, the CS141 can also attach the internal event log that was available until the e-mail was sent. The data log shows the discharge/charge data of the UPS,

Note:

Using the timing function, it is possible to assign different mails to an event with an accurate time delay for an accurate mail documentation of the incident.

Email-Traps

Mail trap messages are automatically generated by industrial systems for information and status reports. Retrieved and evaluated by a corresponding recipient they are very useful inside semi- or full-automated infrastructures. The difference to a normal email is that there is no option to enter custom text or define a different recipient.

A valid mail account must be deposited to send mail traps.

For details, please refer the Chapter *Configuring UPS*

In some cases, administrators need to use different mail accounts - if they choose to one Email account, CS141 offers to copy registration data directly from standard mail configuration:

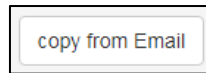

"Copy from Email" duplicates your mail account data for Mail trap services. The only manual task is confirming passwords. In case of an alternative mail account is in use, specify the according access data.

Tutorial: Email-Traps

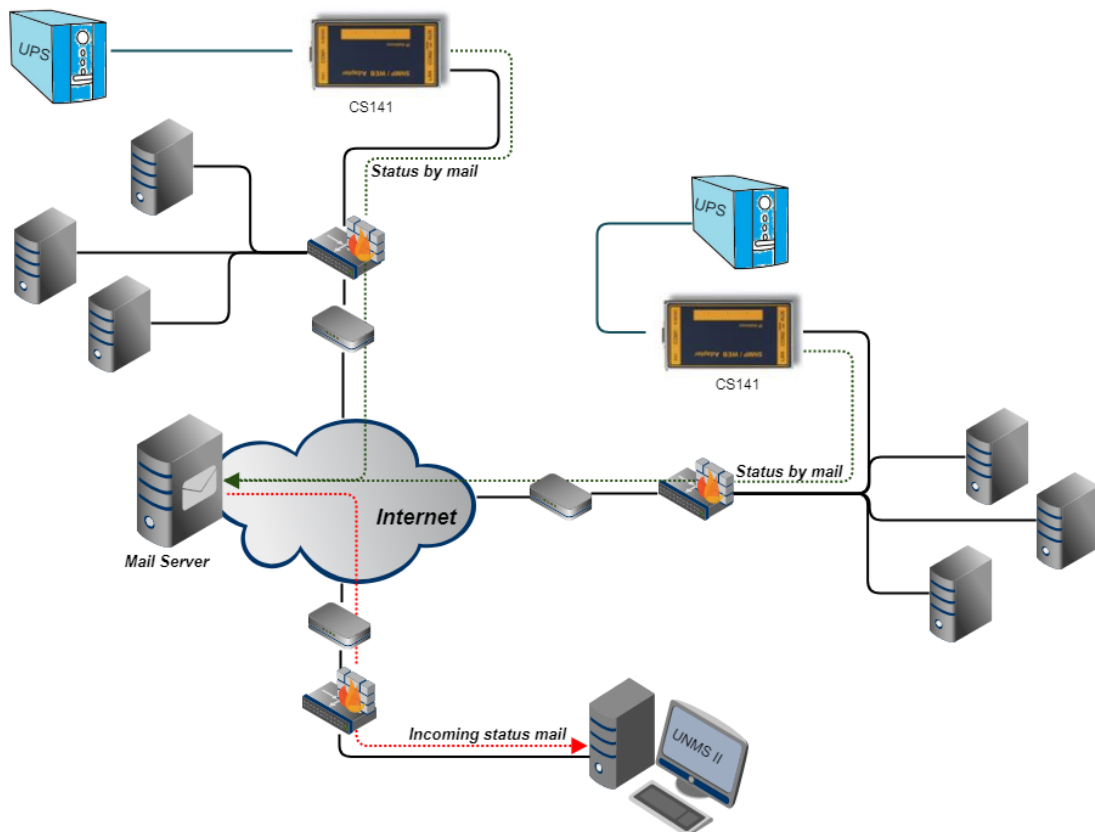

Trap messages are a very popular way to automatically get information from a network. The concept provides that a device sends its status in the form of a standardized data packet as soon as its current status changes. Among other things, the transmitted data strongly depends on the device and its function.

The key feature of a trap message:

The type of transmission is unidirectional - the packet is sent and there is no acknowledgment of receipt. If the device can send the packet, the task is completed. Since the messages are sent only in case of status changes, the destined monitoring tool normally assumes that the last received status received is valid. Especially in weaker networks or in networks, where many messages of this kind are sent. This is an advantage as soon as either a large number of devices have to be monitored or the network is poorly developed:

Both the required computing power and the amount of status data inside a network can be minimized:

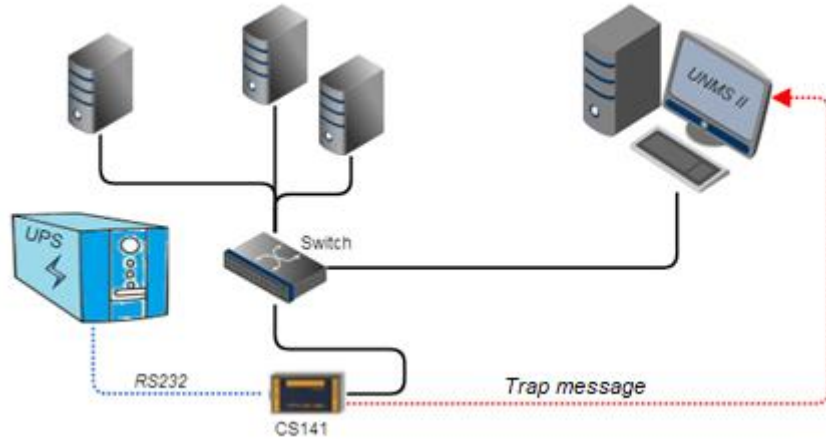

The CS141 is capable to send trap messages to a monitoring software like the UNMS II in order to indicate a status change of a UPS.

Now, there is a problem:

A network grows and for technical reasons, some segments cannot provide a permanent network connection until expensive major network installation works will be done ...

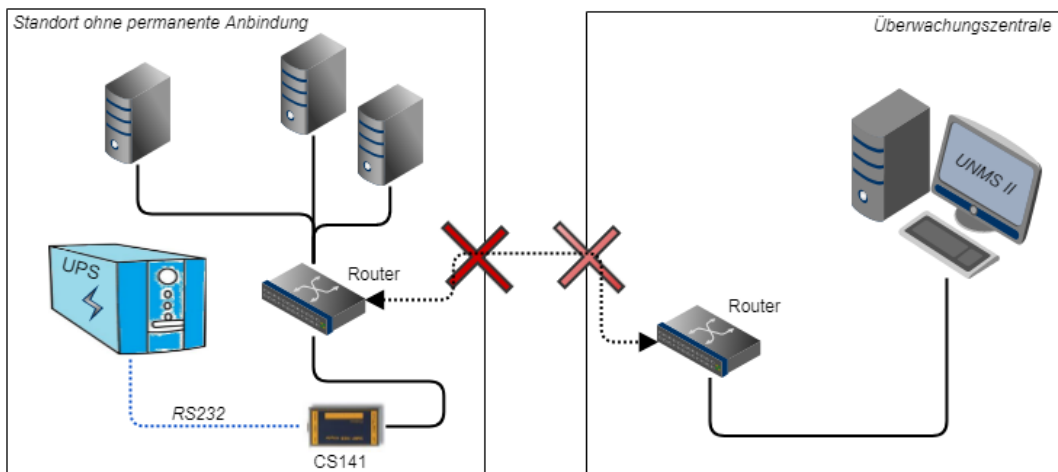

Does the argument of a better connectivity justify the costs of a network implementation or is there a better solution?

With Email-Traps, the CS141 offers an interesting way to meet this situation:

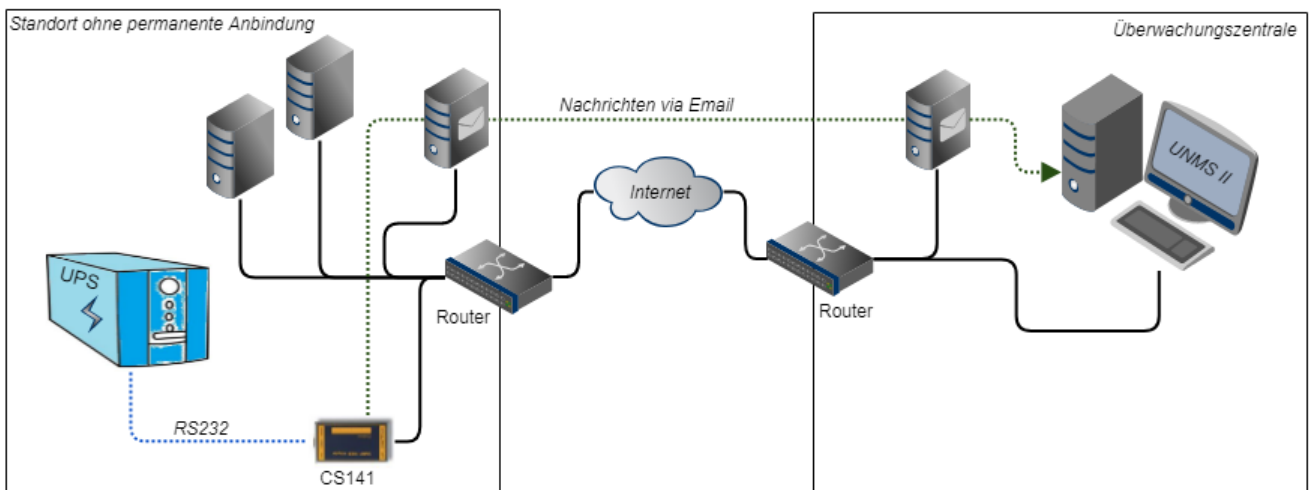

The CS141 uses the e-mail function in order to send an according message if the system status changes - a timestamp ensures that an outdated data package will be registered but not used for the current system status monitoring. The mail server holds the e-mail until a connection is possible - and forwards this mail to a custom e-mail address a UNMS II can access.

The UNMS II is the recipient. It will look for incoming mails and handle them like trap messages.

Note:

The advantage is the fact that local connection options can be used to ensure a basic communication between a device and a monitoring system. The focus is set on ensuring communication - the communication speed depends on the local infrastructure that is available:

The UNMS II displays incoming information directly on arrival, but can not determine when a valid e-mail arrives from a remote system.

How many mail addresses are possible with Mailtraps?

There are actually 2 different ways of looking at-

1. the mail distributor

The UNMS connects to a mailbox, downloads the mails intended for it, and deletes them from the server. A UNMS key provides two installations within a network:

Once is a blind or dummy system for the configuration work, and a "production system. This option provides testing the configurations extensively before using on the production system via backup/restore functions. Now, if both UNMS packages access the same e-mail mailbox, the general uptime and the time of incoming e-mails will decide, which of the two UNMS installations will fetch the e-mail and delete it from the e-mail server.

As a result, e-mails seems to "disappear" from the view of the productive system. The remedy here is a distribution list:

The mail server receives the mail at unms@beispieladresse.net and then distributes it to two different mail addresses:

UNMS 1 "Dummy" fetches its mails exclusively from unms1@beispieladresse.net

UNMS 2 "Production" fetches its mails exclusively from unms2@beispieladresse.net

1. Different mail receiver

This scenario is interesting if service contracts exist, and there is the need of receiving UPS data in parallel to serve maintenance contracts:

To use this function, just configure at E-Mail to: mail1@receiver1.com,mail2@receiver2.com,....

In this way, the service provider and the customer can refer to the same data situation and plan corresponding maintenance windows together.

Which of the two possibilities should be used in this case depends on the operating scenario of the UNMS / CS141 combinations.

Modbus

Field buses are bus systems that connect field devices like sensors or actuators to communicate with a parent automation device.

If several communication participants send their information through the same line, it is necessary to determine who (identifier) will send what (measure, command) at a specified time (initiative). To ensure this communication, standardized protocols will be used.

The Modbus protocol was launched in 1979 by Gould-Modicon for communicating with their own programmable logic controllers, and has become an unofficial standard in the industry due to the fact it is an open protocol.

Since 1999, fieldbuses have been standardized worldwide in the IEC 61158 standard (Digital data communication for measurement and control - Fieldbus for use in industrial control systems). The second generation of fieldbus technology is based on real-time Ethernet.

Note:

For further information, please refer to the Modbus manual, downloadable from the GENEREX website, visit www.generex.de.

Modbus providing devices

Modbus is a protocol for serial communication. The data is transmitted using 16-bit registers (integer) or data byte status information.

Using Modbus has many advantages:

- The basic structure of Modbus has never really changed to ensure best compatibility over the years. The number of unified devices provides a stable platform for integration, maintenance and configuration.
- This open protocol has been established as an unofficial standard in many industrial machines worldwide. As soon as a device supports Modbus, it can usually be integrated into an existing Modbus network.

Modbus can be used as single-master protocol

The master controls the entire transmission and monitors accidental occurring timeouts. The connected slave devices may only send telegrams if requested by the master. For remote control and monitoring of equipment, the Modbus interface in each CS141 can read measuring's, events, status information and other things within the master-slave protocol.

Note:

If you do not find readings you are looking for, do not assume this could be an error. As an example, if you are looking for rare or custom UPS functions, it is possible that the according UPS communicates this to the CS141 via SNMP, but the manufacturer does not store a Modbus address for these readings.

As a consequence, the CS141 will show it with its own web interface, but cannot serve your Modbus query.

Difference between CS141 Modbus and CS141 Professional

Each device of the CS41 family is capable to handle Modbus over IP. The Modbus devices have an RS485 interface instead of the standard mini-DIN connector for sensors, specially designed for Modbus infrastructures.

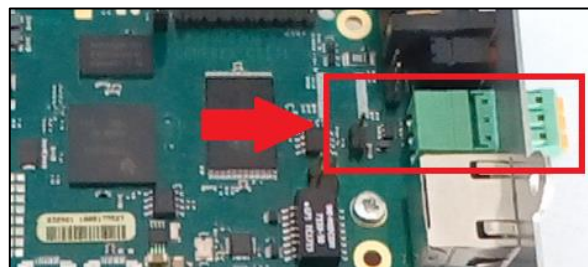

Modbus Pin assignment

As a default, a Modbus plug is installed od delivery. The plug can be removed and later simply assembled to ensure a fast and intuitive wiring procedure.

Please note the plug alignment:

Before wiring, ensure the terminal strips are at top of the cable slots - not below them.

By doing so, the following PIN assignment can be used:

Terminal strip



PIN	Description
1	GND
2	RS485 A+
3	RS485 B -

To insert an appropriate cable, pull back the spring mechanism - the clamp will automatically lock the cable at the desired position.

The Modbus Terminator-PIN

Another difference with the CS141 Professional: The CS141 Modbus adapter is capable to drive a real RS485 Modbus protocol - not only Modbus over IP. In case of operating within a real Modbus environment, you can easily integrate the CS141 Modbus adapter.

Since Modbus expects termination resistors on both the first and last devices in the bus network, the CS141 Modbus offers an optional 120-ohm resistor that can be enabled by setting a PINS.

As a default, this PIN is set to OFF - the CS141 is configured not to be the last device within the Modbus network. If required, this pin can be set manually.

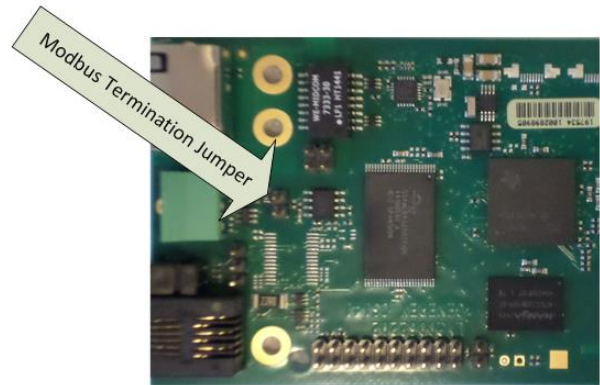

Note:

In general, the CS141 MODBUS will query the UPS via SNMP and provide appropriate MODBUS addresses and values. Due to this fact, the UPS can be queried via MODBUS. Technically, the UPS is not connected to the Modbus network natively. However, the Modbus controller will not be able to recognize this fact.

Modbus über RS485, RS232 und Modbus over IP

As mentioned, all devices of the CS141 family can master MODBUS queries - the difference is in the details: While the CS141 Modbus version comes with an RS485 interface for native integration into a modbus infrastructure, the CS141 professional version uses a point-to-point connection via RS232 and provides the information via Modbus over IP:

Since Modbus via RS232 is usually used when you want to transfer Modbus data from the UPS to another system or special monitoring software, No terminating resistors are necessary for this connection type.

Due to this fact, the hardware layout of the boards changes if compared:



CS141 Modbus

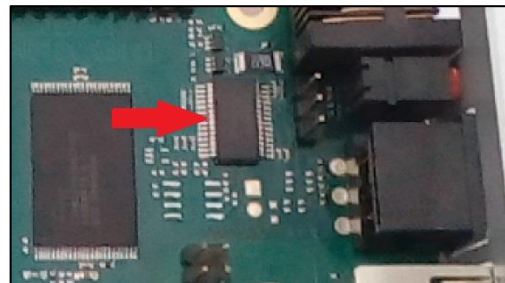

CS141 Professional

If compared to each other, the CS141 Modbus can be easily distinguished from the CS141 Professional.

Since the external interface and the query via LAN can interfere with each other caused by differences in query timing, the parallel use of Modbus over IP and via internal interfaces is not possible - you need to choose between the query options. With these operating conditions Modbus over IP is available:

- The external Modbus interface has been explicitly deactivated on the CS141-SCM / LM - since this interface is an exclusive BUS interface, it is therefore a dedicated menu:

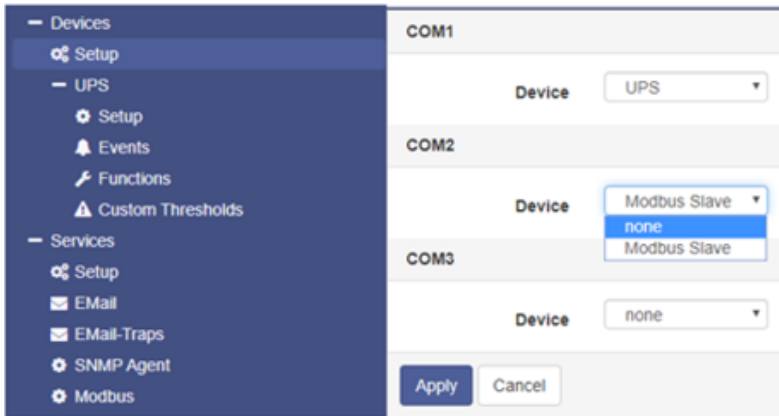

→ COM 2 set to none

The external Modbus interface is disabled and Modbus over IP can be used.

Com 2 set to Modbus Slave

Modbus over IP is disabled and the external interface is enabled.

- Bei dem CS141 Professional verwendet einen multifunktionalen Mini-DIN-Anschluss. Modbus over RS-232 ist daher lediglich eine Anschlussoption, die ausgewählt werden kann:

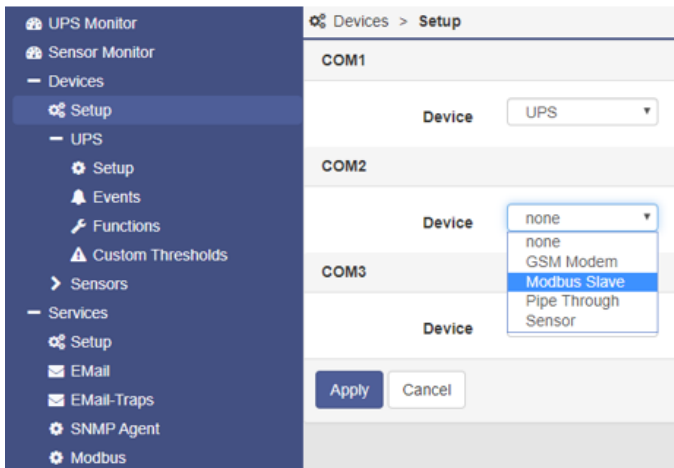

→ COM 2 set to Modbus Slave

Modbus over IP is disabled, Modbus over RS232 is active. The management card can be connect to an external device for Modbus queries.

COM2 set to any other setting

Modbus over IP is active and provides Modbus data via network.

Please note:

Depending on the scope of function, the CS141 will provide different menu entries. In addition to the device setup, the Modbus service must be enabled:

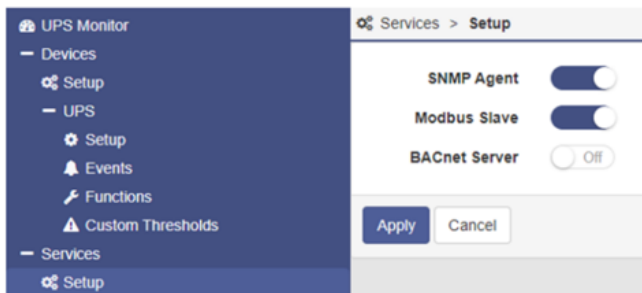

→ The Modbus agent can be enabled or disabled independently to the rest of the configuration of the CS141. If the agent is disabled, Modbus queries will not be answered

Modbus function codes

The CS141 supports the following function codes:

01H	-	Read Coils
02H	-	Read Discrete Inputs
03H	-	Read Holding Registers
04H	-	Read Input Registers
05H	-	Write Single Coil

Please note that the actual function codes depend on the UPS connected to the CS141, because the UPS must support commands of this type. In general, the functions 03H and 04H are normally supported by standard UPS systems, whereby the CS141 makes no difference between these two functions. Since the CS141 supports polling speeds of up to 38400 baud, it can be flexibly integrated into an existing system.

Modbus error codes

Except for broadcast messages, where the master device sends a request to slave devices, a master always expects a unique and valid response from the according requested slave. If the reply does not meet the specifications, the packet is discarded with a corresponding error message.

The following possible events may occur when a master device requests data from its slaves:

1. The slave responds accordingly with a valid data packet.

The Master will react accordingly.

2. The slave device does not receive the request from the master.

This event occurs, for example, in the event of a communication error. Since the request was not answered from the master's point of view, the master reacts with a corresponding timeout.

3. Messages from the master or the slave are invalid

Such a phenomenon is an example for a forgotten termination resistors they have not been set. Data is sent, but there are clearly errors in parity, LRC or CRC within the data packet. Since invalid packets are dropped by devices, the slave will usually reject to respond. The master generally notifies in case of an incorrect response a corresponding timeout.

4. The request a slave receives is valid, but cannot answer

If the slave unit receives a request without a communication error, but a readout is not possible due to e.g. a non-existent register, the slave units' response is a specific exception message to inform the master unit about the reason for the error.

Possible error codes coming with a CS141

- 02H Illegal Data Address
The data address received with the valid request cannot be processed due to a wrong or not existing the address.
- 03H Illegal Data Value
A value that was included in the request is not a permissible value for the slave.
- 06H Slave device busy
The slave has received a valid request, but is currently busy with a time-intensive or time-critical process. Since of this fact, the CS141 is for the moment not able to process the request - the master will not declare a timeout, but will repeat the request at a later time again.

How to configure Modbus

For this configuration step, navigate to the following menu:

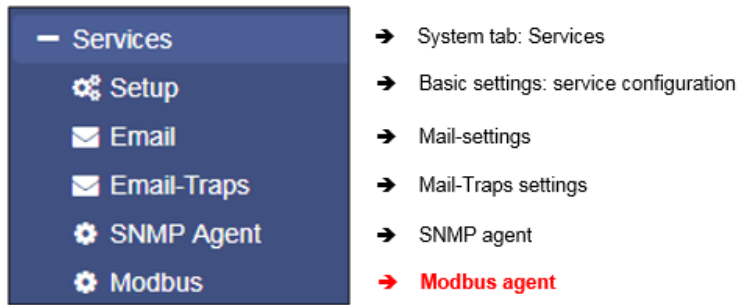

Since Modbus is standardized, the basic configuration is intuitive to handle. To configure the Modbus agent, go to services and open Modbus.

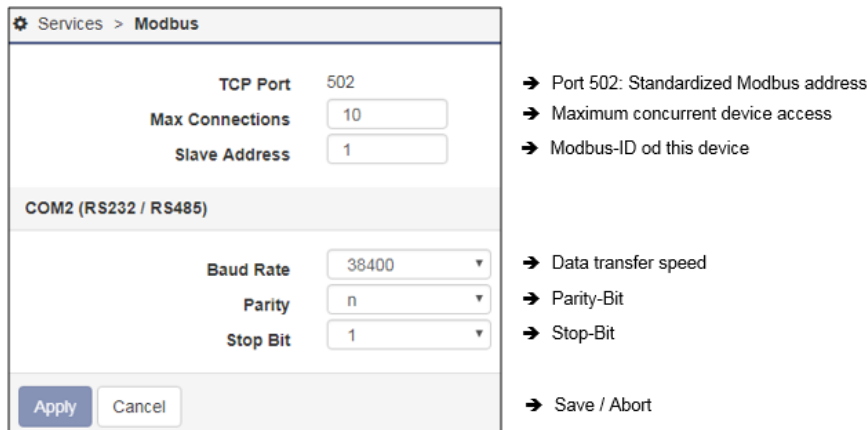

TCP Port 502

The TCP port 502 is a static port setting within the Modbus standard that cannot be changed or customized without leaving standards - This port value is hardcoded inside the CS141 source code.

Slave Address

The Modbus slave is the ID that make a Modbus device addressable. The Slave ID mentioned by a master's query will cause this device to answer This ID may be customized, but only exist once inside a Modbus network.

Note:

Doubling a Modbus Slave Address will not result in a complete network short-circuit - if the ID is requested by a Modbus master, both addressed slave devices will respond. This will cause the Modbus Master to display misleading data accordingly or assumes a timeout due to the fact the data packets are not valid.

In this case, check the uniqueness of the slave address and, if necessary, assign a free Modbus address.

Baud Rate

The baud rate defines the data transmission speed for Modbus queries and answers. Please note that the polling speed through the master must be identical to the answering speed configured at the slave to avoid communication lost issues.

Parity

When transmitting data in the form of a bit stream, the parity bit will ensure an error detection can be performed.

The value of the parity bit is calculated by the transmitter and communicated to the receiver accordingly. The receiver of the data stream uses the same mathematical algorithm to verify valid data and find corrupt data packets. Thereby Sender and receiver must therefore agree beforehand on how to perform the parity calculation:

The parity calculation can be interpreted as even or odd.

Example: even parity

If devices agree to calculate with even parity, the number of all "1 bits" will be counted within the data word. The task of the parity bit is to set the result to an even number:

Therefore, if the number of bits to be checked within a data packet is even, the parity bit must be transferred as 0, otherwise the total count will be not an even value. Differently configured devices would therefore declare an odd or an even value valid and discard other data packets accordingly as invalid.

Der CS141 offers three options:

n	No parity control
o	Odd parity control
e	Even parity control

By default, the CS141 is shipped with the value n for no parity check.

Stop Bit

A stop bit defines the end of a data word within a data stream and is used in asynchronous data transfer:

Usually, a corresponding start bit is sent before a data word transmission starts. Start/Stop bits allow a receiving device to recognize the beginning as well as the end of a data word inside a data stream. In principle, it is also a high signal, but the level of the signal differs from the subsequent data word.

At the end, depending on the configuration, one or two stop bits are set to determine the explicit end of this data word. As a consequence, no valid data word can be present between stop bits and the next start bit:

The receiving device will recognize these data as discardable and ignores them accordingly.

If data transfer issues cause a synchronization lost, the device will look for predefined bit chains for re-synchronization.

Note:

If more than one Modbus device is on the same ID, they will all start sending data to serve the master's query.

Amongst other things, the start and stop bits within the network will begin cross talking, causing problems with the assignment of valid and invalid data packets.

The Stop Bit function defines whether the CS141 should send one or two corresponding stop bits

Mit der Funktion *Stop Bit* definieren Sie, ob der CS141 einen oder zwei entsprechende Stop Bits senden soll.

Apply/Cancel

This function saves the entered data and restarts the corresponding services on the fly. A complete reboot of the CS411 is not necessary:

- Apply: Save changes and restart the service as required
- Cancel: Withdraw settings and return to current state.

Note:

The standard UPS Modbus addresses can be found in the appendix of this manual starting on page XXX.

The CS141 uses a valid Modbus reading range from 0-65535. Some Programs like "Modbus Poll" use the same range. Other Modbus polling clients may use 1 - 65536 - in this case, you need to correct this by adding 1 to the original value.

Using Modbus over IP and Modbus RS 232/485 simultaneously

As a standard, the CS141 is configured to use either Modbus over IP or Modbus over RS 232 / 485 to serve a modbus master in order to ensure both, a fast and a stable connection without any timeouts:

- As long as the hardware interface is disabled or assigned to other devices, Modbus over IP will start.
- If COM 2 (or the Modbus interface) is enabled, Modbus over IP will be automatically disabled by design.

For technical reasons, it may be necessary to use both operating modes in parallel - in this case the CS141 can be configured to serve both connection methods at the same time.

How to use Modbus over IP and Modbus RS 232 / 485 simultaneously

Note:

In some cases, queries running in parallel from different signal sources may cause a timing problem - caused by sporadic time lags, a Modbus master will incorrectly report a timeout. If you are using the simultaneous Modbus operation mode, please ensure to adapt the master's time window so the CS141 has enough time to send an answer.

To activate the Simultan Modbus Request Mode, these menus must be configured:

<ul style="list-style-type: none"> — Devices ⚙️ Setup ➤ UPS — Services ⚙️ Setup ✉️ EMail ✉️ EMail-Traps ⚙️ SNMP Agent ⚙️ Modbus 	<ul style="list-style-type: none"> ➔ Set COM 2 to "Modbus" <ul style="list-style-type: none"> ○ For the CS141 SCM, activate the Modbus Interface ○ For the CS141 SC / L, enable Modbus R232 ➔ Enable the Modbus service ➔ Configure the interface
--	---

Stepp 1: Activate the hardware interface

At Devices, select Modbus at COM 2.

Stepp 2: Prepare the Modbus Service

At Services > Setup, set the "Modbus sliding switch" to OFF and press Apply. Wait some seconds and enable the service. Please note, the service will only start with click on "Apply". There is no need to restart the device.

Stepp 3: Configure the interface

At Services>Modbus, search for "Activate TCP/IP and Serial simulatnously:

Activate TCP/IP and Serial simultaneously

To be used with caution:

In this mode, external TCP/IP requests and also serial requests are served simultaneously, which can lead to loss of some answers on one of or both interfaces.

Therefore, this mode is deactivated by default, and either only TCP/IP or only serial requests are answered.

If "Modbus" is configured on COM2, "TCP/IP" is automatically deactivated and "Serial" is activated; otherwise "TCP/IP" is activated and "Serial" is deactivated.

Click apply to confirm the settings. The CS141 will restart the service into simltaneous operating mode.

Short tutorial: How MODBUS addressing works

When you take a look at the numbers you will notice that this number may tell you ultimately everything. The difficulty is to interpret the number to identify a unique problem and without further explanation, this is a little bit difficult ...

Before you start...

Modbus slaves use a HEX value to send information to a modbus master. After receiving this HEX value, it will be converted into a decimal number. Each HEX value or decimal value stands for a very specific UPS status, which can be interpreted accordingly if a modbus list is available (That's why you need a "MODBUS LIST", you will find this lists in the appendix of this manual).

Example:

UPS_SB_OUTPUT_ACT = 0X0004 -> 4 = Inverter on = UPS OK

The query takes place by a pre configured time window configured at the master. As long as the slave gets a valid request, it will answer accordingly- in this case 0X0004. This means, everything is fine with the UPS.

After some time, the master queries again and receives the following answer:

UPS_SB_BACKUP_MODE = 0x0008 -> 8 battery power

On request, the Modbus slave replies with this status: „The UPS is currently running on batteries “

If the reason is an known error status, the CS141 will provide information about the reason, too:

UPS_SB_INVERTER_FAILURE = 0x0200 -> 512 Inverter Error

For the sake of simplicity and to shorten answers, the modbus slave adds the two HEX values and sends a single collective status report.

As a consequence, the decimal system status jumps from 4 to 524: 4 [inverter on], 8 [system on battery] + 512 [inverter error] on request. Since each status can only exist once a time, a unique status report can be interpreted from the result

How does it work in practice now - a logical numerical example

As an example, the Modbus master asks the CS141 at address 109 for a status value and receives the number 56. This number does not mean anything at first, unless the correct list for the interpretation of the number has been stored for address 109. In this case, this list provides all required information about general status information coming with address 109 to interpret the "number 56":

UPS Status	Hex-Value	Dec-Value	Description
UPS_SB_BYPASS_MODE	0x0001	1	power piped thru
UPS_SB_SHUTDOWN	0x0002	2	shutdown ups
UPS_SB_OUTPUT_ACT	0x0004	4	inverter on = UPS OK
UPS_SB_BACKUP_MODE	0x0008	8	battery power
UPS_SB_BATTERY_LOW	0x0010	16	low battery err
UPS_SB_OVER_TEMP	0x0020	32	over temp err
UPS_SB_TEST_ACT	0x0040	64	test in progress
UPS_SB_INPUT_HIGH	0x0080	128	over power err
UPS_SB_OUTPUT_HIGH	0x0100	256	over load err
UPS_SB_INVERTER_FAILURE	0x0200	512	Inverter error
UPS_SB_BATTERY_BAD	0x0400	1024	Battery error
UPS_SB_ECO_MODE	0x0800	2048	eco - bypass
UPS_SB_INVERTER_WARN	0x1000	4096	eco - bypass
UPS_SB_UPS_FAILED	0x2000	8192	prser flag
UPS_SB_COMM_LOST	0x4000	16384	for snmp
UPS_SB_DVG_ALARM	0x8000	32768	SiteManager/SiteMonitor

1. The *Test in Progress* status will use a count 64, this status cannot be.
2. Since the value of the answer is an even number, the status "1" is dropped..
3. The values 2, 4, 8, 16 and 32 are specified within the modbus list and may only be used once.
 - Since $2+4+8+16$ is not 56, status 32 must be included ($56-32=24$)
 - Furthermore, $2+4+8$ is not 24, therefore the next value we are looking for, is 16 ($24-16=8$)
 - Finally $2+4$ is not 8, the last valid available number must be 8.

Because all other combinations are invalid, the current system status can be found within $32 / 16 / 8$ – all three numbers can be found within the modbus list as seen above.

Other device, same procedure: The GENEREX BACS:Modbus list

As seen in the figure on the right, the basic principle is similar:

In the end, the configured Modbus list decides about available addresses and how to use the values coming with them.

By the way, in some cases, it is necessary to use mathematical formulas for calculating a usable value from a Modbus number. If necessary, it will be explained with the Modbus list coming from a vendor.

Current and Voltage values

Current and voltage are measured values, but the interpretation of the number follows the same principles. Once both, the register and the meaning of the value, is known, the returned number can be easily evaluated to determine a requested system status.

Keep in mind to follow the instructions how a number is to be interpreted and refer to the documentation to convert numbers into measurement data. If in doubt, please contact the technical support of the according device.

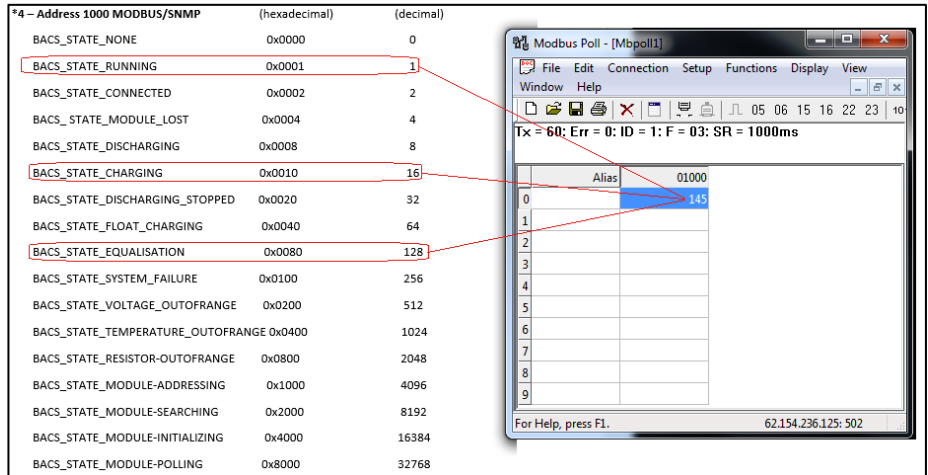

SNMP

For this configuration step, navigate to the following menu:

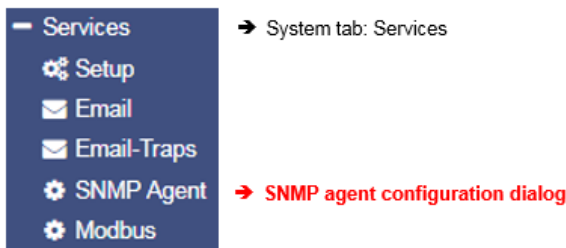

Developed by the IETF the Simple Network Management Protocol is designed for monitoring and controlling network elements from a central station. The protocol controls the communication traffic between monitored devices and monitoring stations:

SNMP describes the structure of the data packets that can be sent as well as the entire communication process. The CS141 can fully be integrated into a network with SNMP monitoring. The build-in SNMP agent regulates both - receiving and sending corresponding requests.



Note:

SNMP V1.0 is not officially supported by the CS141. We recommend the use version 2.0 upward. However, since V1.0 is largely included in V2.0, the CS141 will respond to SNMP-V1 requests, but using V1.0 will be out of official supporter's guidance.

The CS141 supports SNMP v2 as well as SNMP v3

The difference that SNMP v2 and v3:



SNMP v2 works on behalf of legitimating an IP address inside user communities, SNMP v3 is based on direct user permissions with name and password.

Configuring SNMP V2:

The overview shows all configured communities:



To configure new SNMP permissions, click +

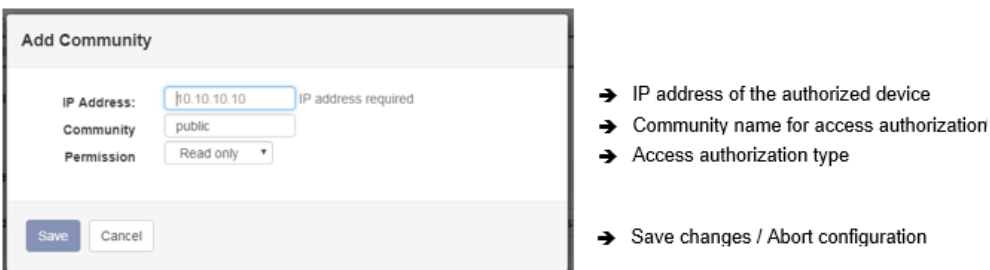

IP address

Under IP Address, enter the IP address of the authorized computer to allow access to the CS141 device via SNMP v2. Thereby the name of the community defines the authorization group.

Permission

Defines permissions during access:

Read only
Read/Write

Devices dealing inside this permission group have read-only permissions
Devices dealing inside this authorization group can read and write /delete data packets.

Set up trap receivers

Set up trap receivers

What are SNMP traps for?

In principle, an agent monitoring a system can unsolicited send a so-called trap packet to its management station should this be required. Among other things, the status of the monitored device is communicated. On the other hand, the agent can receive and service requests from his manager. There are two ports required by default:

Port 161 Required by the agent on the device to receive the requests
Port 162 Required by the management station to receive messages

If these ports are blocked, the communication will not work.

Configuring trap receivers on the CS141

The advantage of the trap messages is that the CS141 can automatically inform about changes in the UPS.

SNMP Trap Receivers	
+	Address
	Community
←	

Apply Cancel

To add a new trap receiver, click **+**,

Since trap messages are sent exclusively to inform about status changes, no read / write operations permissions are required.

Enter the recipient's IP address as well as a valid community.

With Save button, CS141 takes over the settings and the SNMP agent will be restarted. The CS141 will not need to be rebooted.

Add Trap Receiver

IP Address: IP address required

Community:

Save Cancel

Trap receiver test

The newly set-up trap receivers can then be tested:

For an SNMP test, each device of the CS141 product family provides a practical test tool to check if the trap receiver is online and available: Simply select a trap from the list of available traps and click on the test button.

Your receiver should first display the trap and then remove it from the list of active system events.

SNMP-Traps testen

Select a device and a corresponding trap to send to the receiver(s) defined above.
 Ein TrapAlarmEntryAdded und ein TrapAlarmEntryRemoved werden gesendet.
Bitte beachten Sie: Um die neu hinzugefügten Empfänger zu testen, ist es erforderlich, die Konfiguration zu speichern.

Gerät USV

Trap AlarmBatteryBad

Oid 1.3.6.1.2.1.33.1.6.3.1

Tipp:
 Trap messages are automatically generated messages that do not request confirmation - a device that sends trap messages generally does not know whether the messages have arrived. Consequently, it will not be possible to log any information about receipt.

Configuring SNMP v3

The overview shows all configured users:

SNMP User	
+	User
	Access
←	

Since SNMPv3 is user-based, you need to configure single users instead of communities. Click **+** to configure a new user:

Add User

User: My_User

Permission: Read only

Security Level: No Security

- ➔ Add user name
- ➔ Toggle Read/write permission
- ➔ Access control to CS141

- ➔ Save changes / Abort configuration

User

SNMP v3 dispenses with the possibility of setting up authorized IP addresses and user groups. Administrators need to add a local user inside the CS141 device.

Read-only / Read Write

As a standard, any user gets the permission for both - reading and writing. In some cases, this may be not allowed by administrators. To prevent SNMP users from writing data, activate the option *Read only*

SNMP v3: Security Level description

Authentication

Defines security level and password control to access the CS141 device using SNMP v3:

No security	no passwords or encryption is required
Authenticities	Single password request.
Authentication and Privacy	The connection is additionally encrypted and two passwords are required.

Auth.	Algorithm <input checked="" type="radio"/> MD5
	<input type="radio"/> SHA
	Password <input type="text"/>
Privacy	Privacy <input checked="" type="radio"/> DES
	Algorithm <input type="radio"/> AES
	Privacy Password <input type="text"/>

→ Passwort für die Abfrage von Daten auf Benutzerebene
Maximale Passwortlänge: 16 Zeichen

→ Privacy Enhanced: The connection ist encrypted
Maximum Password length: 16 characters

MD5 – Message-Digest Algorhythm

With this method, a 128-bit hash value is generated from a message (e.g. a password), which can be used to check the transmission for correctness relatively easily. The advantage is the low computing power required for the process.

SHA – Secure Hash Algorhythm

Basically, it does the same thing, is a little more flexible, but proceeds differently. This method refers to a group of standardized cryptological hash functions that calculate a hash value that cannot be traced back to the end.

Which of the two methods you must select for authentication depends on the specifications of the respective network operator.

Privay Options

In addition to the authentication, you can encrypt the data transmission via the privacy options:

DES – Data Enchryption Standard

DES is a very widely used standard that uses a symmetric encryption algorithm. An identical key is used for both encryption and decryption.

AES – Advanced Enchryption Standard

AES is also widely used and also belongs to the symmetric encryption methods. As the successor to DES, however, it has the advantage that it is more flexible and the hash value cannot be calculated back. However, since other algorithms are used here, it is not possible to decrypt DES-encrypted data with AES.

Which methods should I set?

The respective encryption methods differ fundamentally and are not compatible with each other. Since all methods with their concepts are largely considered "secure" at the current state, the specifications of the respective network advertising operator in which you want to integrate the CS141 must be observed for the correct settings. The following combinations are possible:

- MD5 / DES
- MD5 / AES
- SHA / DES
- SHA / AES

You will receive the necessary access data from the responsible network supervisor / administrator.

Note:

Please note that in addition to the correct access data, the encryption type must also be identical, otherwise no connection will be established.

Configure TRAP receiver dealing with SNMP v3

To set up a trap receiver dealing with SNMP v3, you need to create a suitable user. This user can then be selected as the trap recipient in SNMP v3.

Die SNMP v3 Engine ID

The engine ID is used by SNMPv3 agents to uniquely identify a device. The CS141 uses its own MAC address with the prefix 80.00.1F.88.03.[XXX] by default.

The MAC address can be found clearly under System>About:

As an example, the Engine ID for this CS141 device is:

80.00.1F.88.03.00.30.D6.16.BB.D4

Network	
MAC Address	00-30-d6-16-bb-d4
Hostname	cs141
Domain	localdomain
Timeserver Address 1	0.pool.ntp.org
Timeserver Address 2	1.pool.ntp.org
Network Configuration Mode	Static IP address

Trap receiver test

After configuration work is done, use the test function to test the SNMP v3 trap receiver:

To do this, simply select the desired trap and press the test button.

The test message should be displayed immediately at the corresponding receiving system after pressing the test button.

Note:

As with SNMP v2, the trap messages are automatically generated messages that do not request confirmation - a device that sends trap messages, generally does not know whether the messages have arrived. Consequently, it will not be possible to log any information about a receipt.

Restarting SNMP agent

This function is available up to firmware 1.78. With firmware 1.80, this feature is an automated background process. No configuration is required.

For this configuration step, navigate to the following menu:

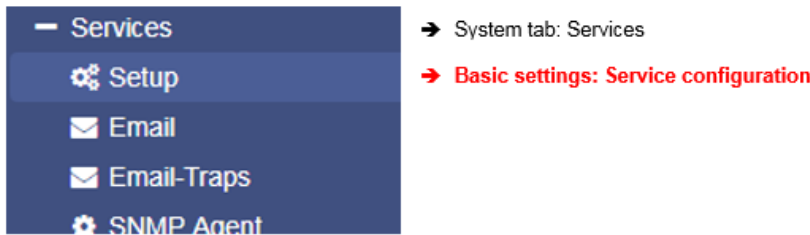

Within a specific and non-standard operating environment, the SNMP agent may stop responding as expected. The CS141 therefore provides a sub system to ensure the SNMP agent is running and alive.

Recovery		
Service	Action	Delay [Min]
SNMP Agent	No Action ▼	1

Apply Cancel

In case of the SNMP agent suddenly dies, these options are available:

No action	the recovery service will not bother the SNMP agent with something like restarting.
Restart	the recovery service will restart the SNMP agent if it does not answer.
Delay [Min]	time delay until the Recovery service will restart the agent.

Note:

In some cases, SNMP v1 queries may cause a hung up of the SNMP agent. Although not officially supported, the CS141 can work with the appropriate SNMP v.1 queries. The agent recovery service ensures that the agent is automatically restarted in case of doubt.

BACNET

With firmware release 1.88, the official BACnet standard is supported. You will find this menu only after running an update to at least this firmware version.

Some facts about BACnet*Where is BACnet from?*

In 1987, the American Society of Heating Refrigeration and AirConditioning Engineering - known as ASHRAE - founded the standard project committee SPC2 135P - members of this committee included companies like Andover Controls, Honeywell, Johnson Controls, Trane and many others. The thankless task of this convened committee was to define a communication protocol for the monitoring, regulation and energy management of buildings. However, in December 1995 and after some back and forth as well as several submitted designs a solution was found: BACnet was adopted as the ASHRAE / ANSI standard by the American National Standards Institute. Just three years later, the standard was initially adopted by Europe as DIN V ENV 1805-1. BACnet has become one of the most widely used standard in America and thanks to its flexibility, extensive building management, automation can be implemented and easily expanded by new devices.

The future of BACnet: BACnet over IP

With BACnet over IP, BACnet goes on:

Existing IT infrastructures can be used, which significantly reduces costs for implementation. Ultimately, you only need a few BACnet-compatible network infrastructure devices like routers and switches with today's standard RJ45 ports.

Requirements

BACnet over IP is based on existing TCP / IP structures, but extends these by a lot of functions that are required in building automation. It is important that a BACnet device only works if the corresponding infrastructure supports routing the BACnet extended protocol - for example, routers and switches must also be able to handle BACnet over IP. Alternatively, BACnet-compatible routers must be installed to connect BACnet segments with each via common network hardware. For the exact configuration of the existing BACnet infrastructure, please contact your local system administrator.

Required ports to use BACnet over IP

BACnet uses the UDP protocol and usually these standard ports:

- 47808 or 47809

Note:

Unlike e.g. Modbus, the standard ports do not follow standards in port binding. Due to this fact, BACnet does not specify any port that must be used for devices:

You can set up any port for your BACnet system that fits to your IT infrastructure. However, more modern BACnet port objects require support in the areas 47808 - 47823 (0xBAC0 - 0xBACF) and for the dynamic port areas 49152 - 65535

Please refer to your local system administrator for the correct port settings.

CS141 BACNET settings

For this configuration step, you need the following menus:

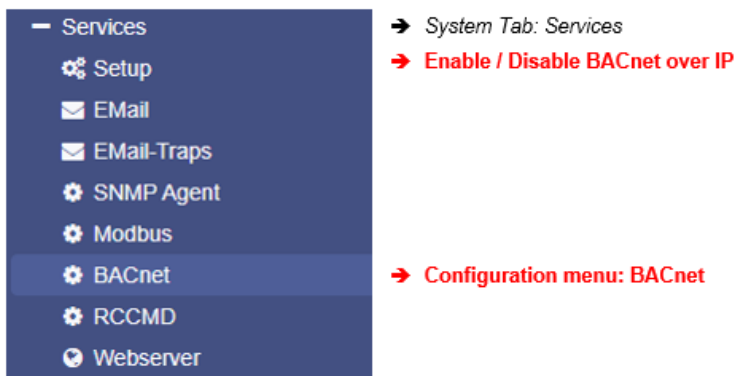

BACnet over IP does not work "out of the box" - some configuration work is required. To do this, open the menu services and click on BACnet. The following configuration menu will be presented:

The image shows a configuration window titled 'Services > BACnet'. It contains several input fields with corresponding labels and instructions:

- Object Instance Number**: 34 → Define the unique BACnet Object number ID
- APDU Timeout**: 3000 → Timeout in milliseconds the CS141 will wait for an answer
- Device Description**: CS141 BACnet Device → Explain in freeform text: what is the intention of this device
- Device Location**: Device Location → Explain the physical location of the device
- Model Name**: Device model name → This is the label of the device provided for BACnet
- Object Name**: CS141 BACnet Device → This is the object name for your BACnet management software
- UDP Port**: 47808 → Which UDP port should be used for BACnet?

At the bottom left are 'Apply' and 'Cancel' buttons. A red arrow points to the right with the text 'Save configuration / abort'.

Object Instance Number

The instance number is an unsigned decimal number that can be between 0 and 4,194,302. Each device in a BACnet network is assigned a unique instance number. Please note, devices in different physical network segments that can communicate with each other are in the same BACnet network - they cannot have the same instance number! Do not neglect the uniqueness of the instance number just because you are installing MS / TP devices. MS / TP devices also have MAC addresses and must communicate with BACnet / IP devices via a gateway:

They still have to use a unique BACnet instance numbers that are not allowed to be duplicated anywhere else.

Note:

With BACnet over IP, the CS141 assigns the ID's for device values dynamically and provides them on request with the necessary value descriptions. Since the internal device ID's may change after reconfiguration, a kind of a fixed and pre-defined "BACnet ID list" like a Modbus list is not practicable or used for BACnet over IP.

APDU Timeout

APDU are the "Application Layer Protocol Data Units", the current data packet that is running through your BACnet network. The timeout is the time in milliseconds that the CS141 waits before assuming the loss of a data packet. Why the data packed is lost, can be very different and depends on the network setup.

Device Description

Enter a small description of the function of this device. When querying the CS141 with a BACnet browser, this information is displayed as "device description".

Device Location

Enter the physical location of the device. In case of problems, you will know where this device is installed.

Model Name

This is a free text description of the connected devices, e.g. the UPS or the registration number of a BACS system, etc. This field can be used to provide additional information for technical staff via BACnet.

UDP Port

As a default setting, the CS141 uses port 47808. However, since BACnet does not have any port restrictions by caused by standards, you may assign a port of your choice to fit the CS141 to your existing IT infrastructure

Enable / Disable BACnet

After configuration work is done, enable/disable BACnet support at Services> Configuration by setting the slider for BACnet to ON. The CS141 will enable the corresponding service and start providing BACnet data as configured.

Remote SYSLOG

What is Remote Syslog?

With an organically growing network, the number devices that create locally stored log files grows. Since each devices follows his own method to provide local log file data, it is a big problem to collect and centralize these data for network error analyzes. Remote Syslog follows the idea that as many systems as possible not only manage their log files locally, but also store them in a standardized data format on a central syslog server:

By doing so, higher level management systems are able to automatically access the files search for problems and errors within a network and, if necessary, to initiate appropriate measures.

Rsyslog configuration inside the CS141

For this configuration step, you need the following menus:



Rsyslog does not work "out of the box" - some configuration work is required. To do this, open the menu services and click on Setup to start the initial configuration:



To make the basic settings, click on "RSyslog" under Services. You can define up to two different Syslog receivers by clicking "+":

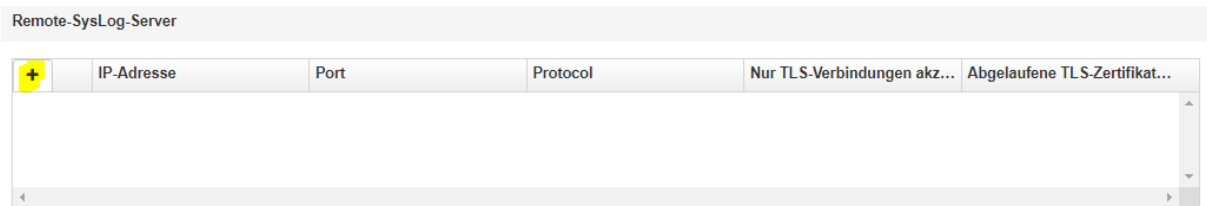

The configuration dialogue:

Add Syslog Server

Remote syslog server IP

Remote syslog server port

Protocol

Accept only TLS connections

Reject expired TLS certificates

- Add the target IP: Define the syslog server.
- Define the port the server is listening.
- Which communication protocol is in use?
- Is TLS connection standard?
- Shall expired certificates be rejected by default?

The menus explained in detail

Remote syslog server IP

With Remote Syslog, the CS141 sends its status messages from the event log file in real time directly to an IP address, where an RSyslog server receives the information and distributes it accordingly on its hard drive. Please note that you cannot define directories or "network drives". For the valid IP address please refer to the local network administrator.

Remote syslog server port

In addition to the IP address, a remote syslog server normally uses a pre-defined port for listening status logs. The default port for using rsyslog is 601. Since this is not an official standard port for rsyslog, the port for the used server may differ. If necessary, refer to the local administrator and change the port setting according to the requirements of the network.

Accept only TLS connection / Reject expired TLS certificates

The CS141 can be advised to use encrypted communication only. If checked, the CS141 will reject expired certificates for communication. These functions are only available if you have imported a valid certificate. Please note that with the use of TLS encryption, further configuration on the corresponding syslog server is necessary.

Tipp:

The functions „Accept Only TLS connections“ and Reject required certificates“ are locked until a valid certificate is uploaded to the CS141.

Importing a TLS –certificate for RSYSLOG

What kind of TLS certificate is needed?

Note:

The short tutorial "Creating a *.pem file" in this manual shows you how to create a valid certificate. All you need to do is renaming the certificate into **rsyslog.pem**. To read the according chapter, click on the following link. This link will forward you to the according chapter:

-> [Click to read the Tutorial](#) <-

A pem file is required for operation with TLS encryption. Make sure that both the rsyslog server and the CS141 use the same certificate, otherwise the encrypted communication cannot take place.

At the CS141, upload and install the certificate by placing the file at the upload box:

Place the file via drag'n'drop and click on upload.

If the certificate has been successfully uploaded, the CS141 will show a corresponding message.

After installing the certificate, these additional functions are available:

- Accept only TLS connection
- Reject expired TLS certificates

Activate the check boxes and save the configuration.

The CS141 takes over your settings and automatically restart the necessary syslog service.

Check list: If the communication with the rsyslog server does not start

1. Check IP address and server port

Larger and well-secured networks may have restricted port access on network devices like manageable switches. As a consequence, the communication is not possible. Please check the internal firewall of the server as well as any 3rd party security solution if the CS141 is allowed to communicate and by the way, check the IP address and port setting whether they are correct.

2. Check network infrastructure

So-called V-LANS are often used in larger networks. Physical ports located on the same switch are stitched to a restricted instance and separated from other ports of the switch. As a consequence, your server may be logically in a complete other network segment but connected to the same switch like the CS141. If your server is in a different network segment, no communication can take place. Check if the all routers and switches are connected and configured as required.

3. Check the certificate(s)

Upload TLS Certificate for rsyslog

Drop rsyslog.pem File here

or click to select

PEM file <no file selected>

The order of the items in rsyslog.pem is important!

```

-----BEGIN RSA PRIVATE KEY-----
[rsyslog private key]
-----END RSA PRIVATE KEY-----

-----BEGIN CERTIFICATE-----
[rsyslog certificate]
-----END CERTIFICATE-----

```

Damaged and incorrectly created certificates (pem-files) mean that no communication can take place. Also make sure that the sender and recipient use matching *.pem files, otherwise TLS will not work.

About the use of SYSLOG

What is the basic idea behind remote syslog?

Anyone who has to manage large networks will find that, especially in the event of a fault, many networked devices produce numerous log files and thus also reveal information about the origin and, of course, the course of a network fault. When evaluating the data, one quickly runs into problems like:

1. organically grown structures have a lot of different network devices in use
2. Log files are not standardized, each manufacturer follows its own ideas.
3. The local storage space of the network devices is limited, with very different consequences
4. Depending on the manufacturer, there are software tools that allow analysis, but the tool is limited to "its" network products
5. Many devices are coming with many passwords which, in the worst case, also have to be entered individually because radius functions are either not implemented at all or a radius server is not available due to the network malfunction.

This list can be extended at will, but in short: in this case, data evaluation will take an unnecessarily long time, and just collecting and preparing data (e.g., copying from a custom tool, downloading and open local log files and manually entering it into a database) will take most of the time.

The solution here is "remote syslog", a function that a good device like the professional CS141 should naturally support:

The idea is that the locally stored log files are also transmitted as a standardized format to a central data log collector - the so-called syslog server. The syslog server simply receives these data and provides them for 3rd party diagnostic software to decide what shall happen after automatic evaluation.

What do I achieve with that?

Beneath saving tons of time that collecting data for evaluation will cost, nearly unlimited memory - All devices of the CS141 product family offer plenty of space for storing system events locally. When this memory is exhausted, the oldest entry is deleted and the newest entry is added. With Syslog, you can also transmit the status messages directly to an external server and thus collect uninterrupted event chains over an almost unlimited period of time.

Why is there no CS141 syslog list of things that will be transmitted?

This would be very difficult, as the CS141 supports many 1000 UPS models from almost all manufacturers on the market, and, depending on the type, can also have additional building management functions. Since many manufacturers and suppliers now use their own terminology for "their" functions, there are no standardized entries available. The CS141 therefore takes its own event log as a blueprint: as soon as you activate remote syslog, everything that is written in there is automatically forwarded as a system status to a syslog server in almost real time. If the syslog server is not available, this is noted accordingly in the CS141 locally. By doing so, you will never again lose a system status message.

Hey, what does „nearly real time “mean?

If the entry appears in the event log by any internal operating system service, the syslog service in CS141 tries to send the entry once to a central collector. If this is not possible, e.g., because the central collector cannot be reached due to a malfunction, the entry is saved locally but not sent again. Instead, a note appears in the event log for this period that there is a malfunction.

Time	Category	Message
contains...	contains:	contains...
08/02/2021, 03:44:43 pm	Event	UPSMAN on N. O. contact has started
08/02/2021, 03:44:12 pm	System	CS141SC V2.01 - OEM 29
08/02/2021, 03:43:07 pm	System	Connecting to remote syslog server failed
08/02/2021, 08:58:06 am	Event	RCCMD Trap "Powerfail on N. O. contact restored"
08/02/2021, 08:58:06 am	Event	UPS Power restored
08/02/2021, 08:57:48 am	Event	Input bad

Is it possible to edit the log entries to get a general log file logic for my diagnostic programs?

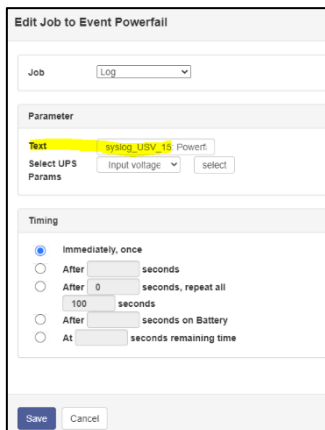

Yes, all log files that depends on a system event can be adapted by adding or editing the job log. As an example, just open the "power failure" event and edit the job "log" to fit to „your" syslog search term.

If, as in the example on the right, you change the job "Log" so that "sysog_USV_15" appears first, then exactly THAT will also be transmitted to the syslog server, as it will be written as a job in the local event log when executed.

Which text you use afterwards is entirely up to you. In this way, you can also equip any available analogue and digital inputs with a job and provide a unique "diagnosis code" so that you can easily find and assign the corresponding error messages afterwards. The C141 adapts this exactly to your specifications:

What is written in the event log, is transmitted exactly as it is.

UPS Configuration

General COM Port setting

For this configuration step, navigate to the following menu:

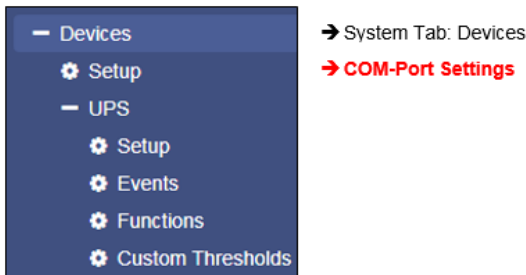

Depending on the design and model, the CS141 provides up to three additional COM ports fulfilling different functions. Please note in some cases submenus will appear to specify functions of devices connected to CS141. To start configuration, go to Devices and press Setup.

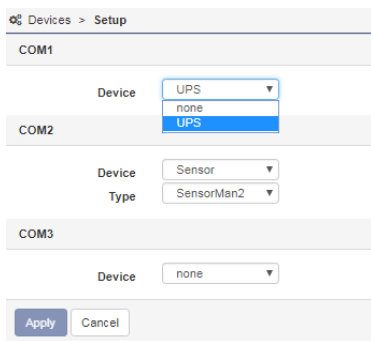

Ensure UPS is selected at COM 1:

As a standard, COM1 the setting UPS should be selected. If not, open the drop-down menu and select UPS.

By pressing Apply this selection will be saved and the CS141 will start required services to communicate with the UPS:

Keep in mind by activating this function, a dummy is set first - this is necessary to allow a general access to the corresponding submenus.

The CS141 will display the current starting phase as well as the success of the activation at the upper task bar.



→ UPS service start up routine in progress

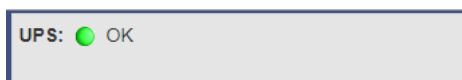

→ The UPS feature finished booting, the UPS menu accessible

Please note that only a dummy without a function has been started at this point, even if a UPS is apparently connected and in operation:

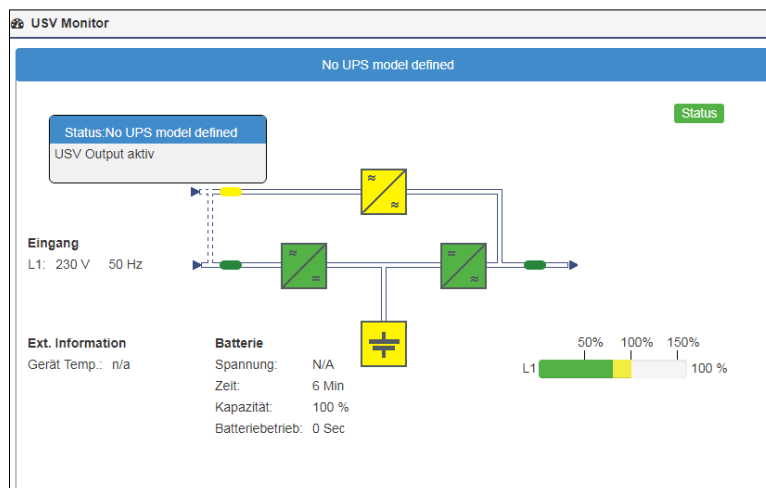

UPS pipe through function

The COM port 2 is flexible and provides to connect various devices to fulfill different functionalities:

- Sensors
- Modbus
- External modems
- UPS Signal piping

In companion to UPS configuration, the Pipe-Through functionality of the CS141 offers an advantage in UPS signal usage:

The signal received from the UPS can be piped through the CS141 and will be available 1:1 at COM port 2.

Due to this fact administrators can harmonize emergency shutdown solutions even if they need to use two different and physically separated networks:

Physically separated network resources can be managed for their own and use simultaneously the same UPS solution.

The configuration of Pipe Through is done on the Web Manager connected to the UPS. The second Web Manager is configured as described on COM 1 but is connected to the COM2 port of the first Web Manager instead of the UPS.

Devices > Setup	
COM1	Device: UPS
COM2	Device: Pipe Through none Sensor GSM Modem Modbus Slave Pipe Through
COM3	Device: Pipe Through
<input type="button" value="Apply"/> <input type="button" value="Cancel"/>	

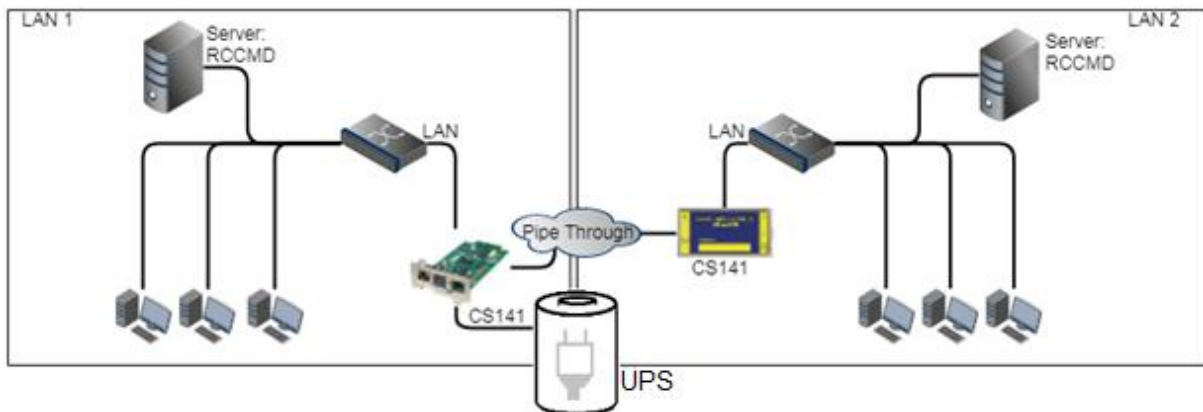
**Note:**

When using the pipe-through function, be sure to set the correct COM2 port to Pipe Through. Furthermore, set the same UPS with identical values on both CS141s.

All other settings may differ.

Configuration of a UPS

For this configuration step, navigate to the following menus:

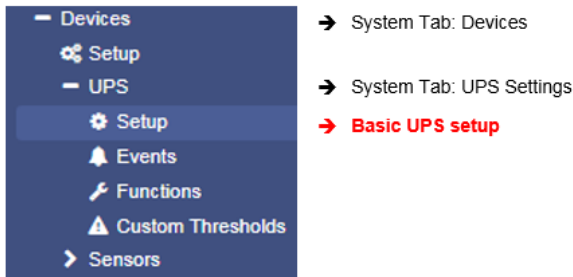

Proceed to submenu UPS and click on Setup to enter the basic UPS configuration menu. This configuration dialog allows to choose the UPS your CS141 is installed to – recommended values will be entered automatically by selecting a UPS:

Devices > UPS > Setup		
Model	No UPS model defined	→ Choose UPS model
Power (VA)	500	→ Maximum output provided by the UPS
Load (VA)	500	→ Maximum load provided by the UPS
Hold Time (min)	10	→ Time window the UPS ensure emergency
Recharge Time (h)	6	→ Time needed for a complete charge cycle
Baud Rate	2400	→ Data transmission speed
Cable Type	R-Open	→ Cable to be used
UPS Id	0	→ If necessary, define a UPS ID
Battery Installation Date		→ Installation date of the batteries.
Battery too old after	48 months	→ Battery change notification
System Shutdown Time	6 minutes	→ Remaining time the UPS shall shut down itself.
<input type="button" value="Apply"/> <input type="button" value="Cancel"/>		→ Save settings / Abort configuration process

In some cases, the UPS protocol does not provide the appropriate data. The CS141 will, based on the data situation, independently calculate the corresponding battery life runtime. In general, these settings do not need to be changed if you can select a UPS model directly from the list - optimized configuration settings will be displayed after selecting the UPS.

if your UPS operates with a system configuration that differs to the basic model, it is possible that you need to adjust these default values: In this case, please refer to your local UPS dealer or the UPS manufacturer of the UPS to get the correct values.

Entering wrong values may cause heavy system failures

Note:
 By default, OEM ID 12 / GENEREX SYSTEMS is set. If you want to use a UPS from a manufacturer that is not listed, take a look at the download area of www.generex.de - Search for the firmware for your UPS and install it as a regular firmware update. Afterwards the corresponding UPS models are available.

Adjustable information about the installed UPS

Model

Defines listed default setting of a UPS including the corresponding communication protocol. When your UPS is listed and communication has been established, telemetry of the UPS typically provides all the necessary data that the CS141 needs to calculate and display autonomy times.

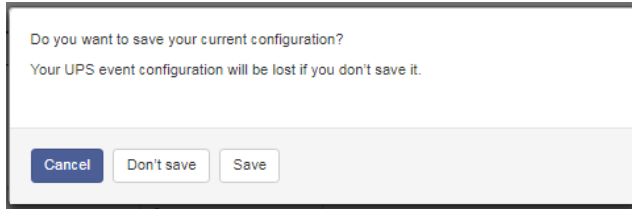

Please note that changing the UPS model will also reset the configuration of the UPS events. The CS141 therefore offers the possibility to create a corresponding backup of the event configuration beforehand:

Cancel:	Do not make any changes to the system
Do not save:	Continue without backup
Save:	Create a Backup of the event handling

Power (VA)

Defines the maximum power in VA the selected UPS in can provide. Exceeding the maximum may cause the UPS getting damaged or even destroyed

Load (VA)

This value defines the maximum load connected to the UPS. Even the possibility is given, exceeding the power VA value can damage or destroy the UPS as well as the installed batteries.

The maximum possible value is less or equal to the value entered at Power (VA).

Hold Time (min)

If main power fails, the batteries of a UPS will ensure this operating time if 100% load is used. The real-life uptime is determined dynamically by the percent of usage: of you use 50% the hold time will raise accordingly.

Note:

Behind the values of power (VA), load (VA), holding time and battery charging time, a mathematical formula is stored - this will allow the CS141 to calculate independently battery operating time and trigger corresponding system events. Thus, allow to use the CS141 even if the UPS protocol cannot provide real-time data - as an example, if a UPS only communicates via switchable contacts or only basic operating states can be detected.

Baud Rate

Different protocols provide different speeds of data transmission. The baud rate defines the speed at which data can be sent and received. An incorrect baud rate can cause communication problems between the CS141 and the UPS.

Cable Type

UPS manufacturers sometimes use specially designed cables for their models. In addition to these in-house developments, there are standardized cable types. These cable types can be used to map different functions and switching states.

UPS-ID

If large UPS systems use more than one UPS module, these modules can be queried directly via a unique ID. „0“ is hereby a something like a broadcast to allow the CS141 search and manage capability to figure out the number of UPS modules. If you change this value, you only get the exact module with this special ID. Otherwise the CS141 will manage all available modules and display them at the monitoring screen.

Battery installation date

The lifespan of batteries running inside a UPS is limited - regular battery maintenance also requires replacement. In order to keep track of larger installations, you may enter the date when the batteries start into operation.

Battery too old after

If entered, the CS141 automatically indicates regular operating period for the installed batteries will expire. By default, the CS141 logs in with appropriate system notes after 48 months. Editing this value will extend or shorten the default time period until the CS141 will start sending maintenance notifications.

System shutdown time

In principle, the system shutdown time is the last emergency shutdown event that will be executed just before the UPS itself will shut down itself to prevent battery damage. This value can be used to trigger the according system event. Please note that this value is an emergency shutdown – it is not suitable to ensure a regular system shutdown.

Apply / Cancel

Apply allows you to save and restart the UPS service on the CS141. Cancel will abort the configuration process and withdraw all settings – they need to be entered again.

Battery Health Level feature

Battery Health Level(%)

The battery health level will be automatically provided by CS141 inside the UPS configuration menu if the UPS connected to the CS141 principally carries out battery testing but does not return a reporting value for "Battery test passed / faulty". Thus, the result needs to be determined by comparing two measurements:

Before battery test starts, the battery voltage will be recorded. This value will be compared with the battery voltage to be found after finishing the battery test. The Battery Health Level (%) setting defines the maximum percentage deviation these two values may differ. On exceeding this value, a battery failure will be displayed.

The default setting for this test is 10% deviation - but can be specified with a custom value between 5% and 30%.

Premium feature: The RFC1628 UPS interface

In some cases, UPS manufacturers supply systems that the CS141 cannot communicate to. As an example, known problems are the card does not fit to the slot, or that the data stream sent by the UPS is not compatible formatted:

UPS manufacturers have installed their own SNMP card, which offers similar functions but may not be compatible to your flexible and powerful GENEREX software environment. To ensure compatibility, the CS141 Web Manager offers the option to connect to any card via SNMP. The condition is that the RFC 1628 MIB is supported by the target card. In order to use this function, it is first necessary to configure a corresponding SNMP Agent at the target UPS.

After that enter the access data in the CS141 UPS menu. The CS141 will restart required services and establish a connection to the destination card.

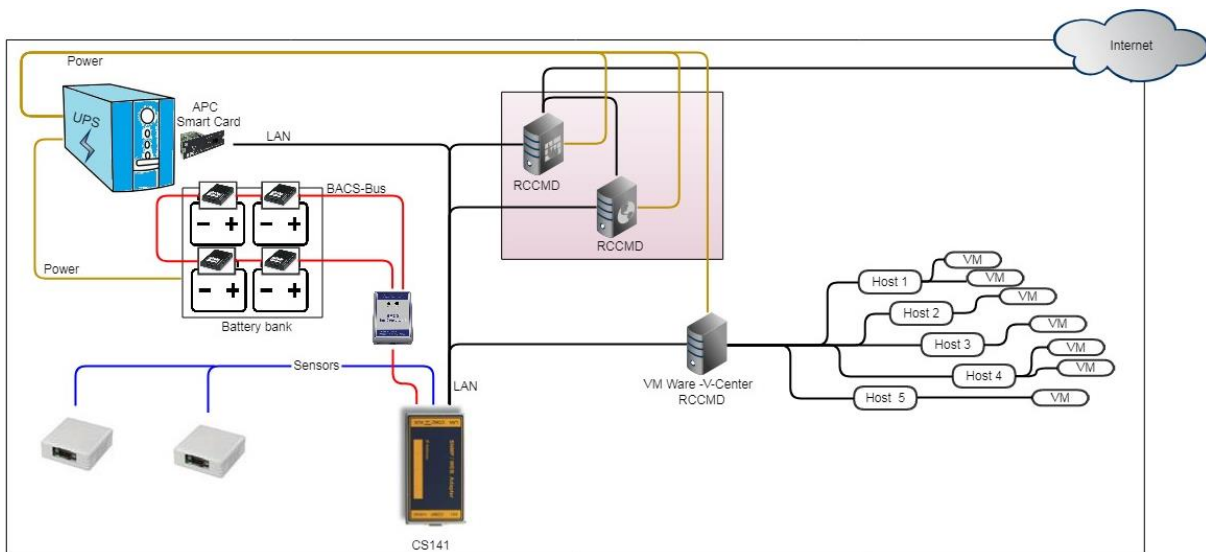

2. Configure RFC 1628 UPS Interface

Model	SNMP UPS-RFC 1628 com
SNMP Version	<input type="radio"/> 1 <input checked="" type="radio"/> 2 <input type="radio"/> 3
IP Address	192.168.2.1
Community	public

Apply Cancel

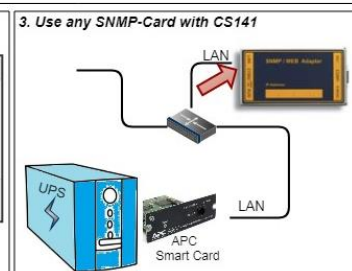

Setting up the target SNMP card with SNMP v2

- Choose UPS model
- Select SNMP Version
- IP-Adresse of the destination
- Select SNMP Community
- Save settings / abort configuration dialog

Model

Choose SNMP UPS-RFC 128 compliant as UPS model

SNMP-Version

Depending on the configuration of your target SNMP card, choose SNMP version 1 or 2

SNMP Community

Enter the SNMP Community configured at target SNMP card

Save/Abort

Abort will withdraw all settings, save will restart required services. After restarting the services CS141 will automatically establish a communication to target SNMP card.

Note:

What is the difference between the RF1628 UPS interface and the APC Smart Network?

In principle, the APC card can handle the RFC1628 standard - you will be able to query basic information about the UPS. However, the APC cards often uses their own OIDs. These OIDs are specific to AP and not conform to the RFC1628 standards.

Therefore, it is recommended to use the APC Smart network setting instead of RFC1628 interface.

Setting up the destination card using SNMP v3 at CS141

- Choose UPS model
- Choose / change SNMP Version
- IP address of the target system
- SNMP User
- Encryption method
- MD5/SHA password
- ES/AES password
- Apply / abort

The CS141 supports SNMP v1, v2, and v3 in this mode.

Enter the access data for the destination card according to your configuration and click *Apply*

UPS with center tab

Tipp:

The CS141 will provide this function in case of using a UPS with center tab support.

What is a 'Center Tap'

Modern UPS systems divide their single battery pack into two symmetrical pack parts and use a center tap. By using a center tap, they increase the nominal efficiency:

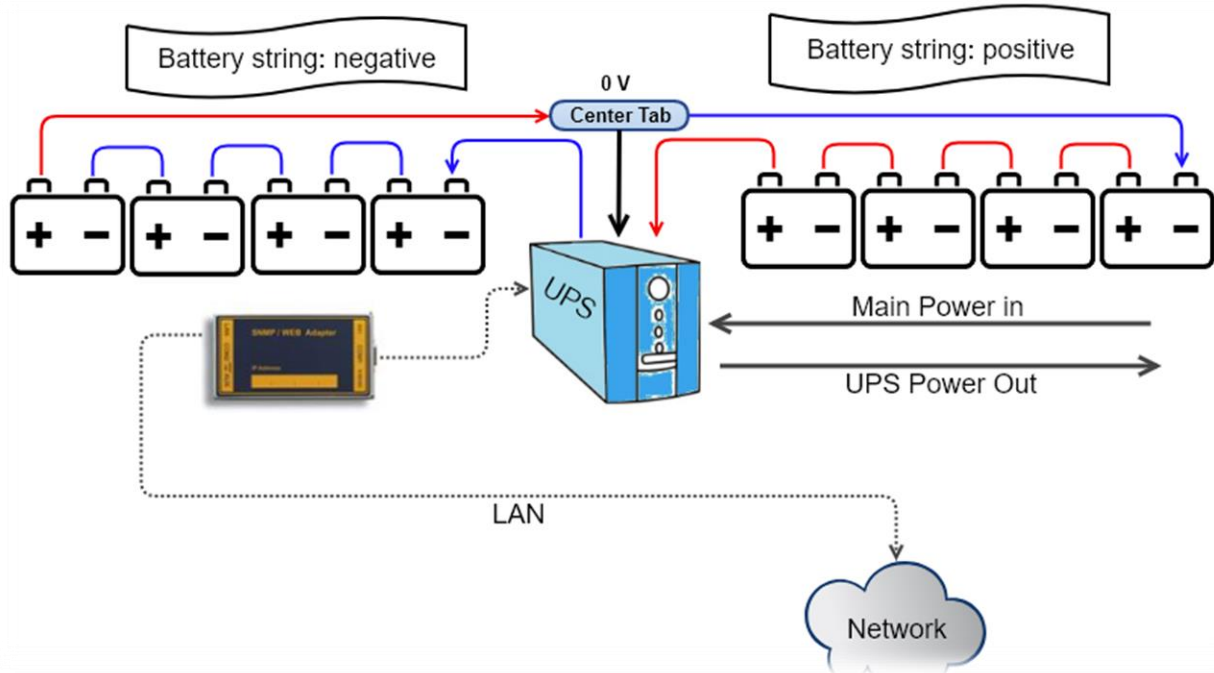

Measurement difference and charge difference

The measurement when using a center tap is basically a way of looking at it:

You measure from the UPS to the center tap and then on the other side from the center tap back to the UPS. Since the batteries all remain connected in series, two phenomena can be noticed when there are voltage problems: If a battery has a problem on the negative string, the general voltage for all batteries will decrease.

The individual measurements of the string will show more details:

1. The total voltage for all batteries drops.
2. Measured from the UPS to the center tap at the negative string will indicate the missing string voltage.
3. Measured from the center tap back to the UPS on the positive side shows that all batteries work as desired.

Ideally, a UPS can show itself in which battery site a problem could generally exist - there is no need of inspecting all batteries.

Where the problems with the UPS start

A UPS has a blind spot. Although it can measure the differences, dealing with the measurements is a little bit limited:

Since batteries age individually even with the same type of use, the measurement data of the two strings will drift apart at the latest with the natural aging process. As soon as a certain threshold value is exceeded, a UPS system reports a general battery fault, but usually too late:

It is no longer possible to estimate how many batteries have hidden defects due to the imbalance. Most of the time the UPS fails due to the hidden drifting process in an unfortunate moment.

The CS141 can monitor precisely these "hidden drift processes" and issue warnings and alarms in good time if there are questionable values, thus providing the responsible maintenance staff with valuable additional time windows for maintenance work.

CS141 settings

For this setting, you need to use a UPS with a center tap.

For setting up this special function, navigat to the following menus:



This configuration menu is a little bit unusual: On the one hand it is a UPS menu, on the other hand there is a limited purpose how to use this function. Therefore, it was filed under the custom thresholds.

Note:

This configuration only makes sense if you explicitly use a UPS a center tap is used. Since we are anticipating something at this point, we will only deal with this one aspect of the custom thresholds at this point - further information can be found in this manual in the chapter "Custom Thresholds".

First click on Custom Thresholds in the UPS configuration menu and enable this function:

		IVIII	
<input type="checkbox"/> Battery voltage	out of range	0	V
<input type="checkbox"/> UPS Temperature	out of range	0	°C
<input type="checkbox"/> Input voltage P-N	out of range	0	V
<input type="checkbox"/> Seconds on Battery	greater than	0	s
<input type="checkbox"/> Battery Autonomy	less than	0	m
<input type="checkbox"/> Battery charge	less than	0	%
<input checked="" type="checkbox"/> Battery symmetry	greater than	0	V
pos./neg. String			
<input type="checkbox"/> Output load	less than	10	%

This option enables the monitoring of the general voltage difference - The CS141 looks at both string voltages and determines the general difference between them. If the argument "greater than" applies, an alarm condition exists. This alarm condition is a UPS event to which jobs can be assigned to.

Choose your alarm notification state:

You have the choice between a single alarm job or a warning and alarm behavior. If you only want a single note, just activate the warning state. Otherwise use warning and alarm notification. Please note, that the alarm condition is always is the escalated system state of the warning.

Warning – the „yellow alert“

If enabled, the CS141 issues a warning as soon as the two lines have left the configured voltage range. This warning is active as long as the problem persists. Since the voltage drift is a dynamic process, you may receive the warnings in certain phases of use and need to decide if further evaluation of the information is necessary.

Alarm – the „red alert“

The alarm can be switched independently of a warning - so if you want to have a warning first and then an alarm, the alarm value must be higher than for the warning (e.g. with a 3 volt drift, the warning is active, an alarm is triggered at 5 volt).

Adding a job

Since these are freeform defined UPS events, the events to the system states are displayed as a regular UPS event. In order to receive a reaction to these events, so-called jobs have to be stored in the UPS "Events" menu. To do this, click on the UPS "Events" menu.

<input type="checkbox"/>	<input type="checkbox"/>	<input type="checkbox"/>	<input type="checkbox"/>	Battery symmetry pos./neg. String Threshold Warning On	1	1	0	0
				Job Typ	Wann	Parameter		
<input type="checkbox"/>	<input type="checkbox"/>	<input type="checkbox"/>	<input type="checkbox"/>	Log	Einmal, sofort	{"text": "Information: Battery symmetry pos./neg. String Threshold Warning On"}		
>	<input type="checkbox"/>	<input type="checkbox"/>	<input type="checkbox"/>	Battery symmetry pos./neg. String Threshold Warning Off	1	1	0	0
>	<input type="checkbox"/>	<input type="checkbox"/>	<input type="checkbox"/>	Battery symmetry pos./neg. String Threshold Alarm On	1	1	0	0
>	<input type="checkbox"/>	<input type="checkbox"/>	<input type="checkbox"/>	Battery symmetry pos./neg. String Threshold Alarm Off	1	1	0	0

The activated custom thresholds can be found as events in the UPS list. As a default, only a log entry configured. Click **+** to add a new job. Please note that some jobs include external accessories, software clients or further configurations such as need an accessible mail server.

Note:
A detailed description how to configure the event control handling can be found in this manual in chapter **Event handling**

UPS-Monitor: Checking UPS Settings

UPS Monitor

Sensor Monitor



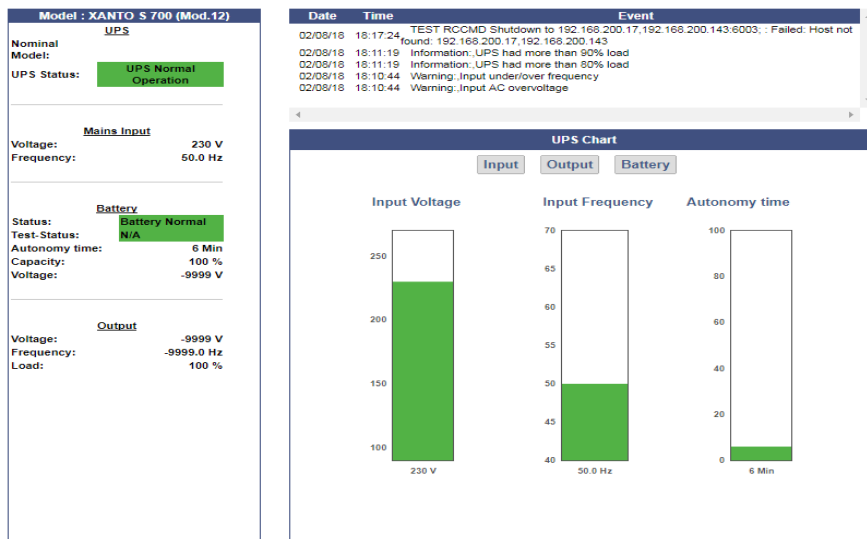

➔
Realtime UPS monitoring screen

➔
Realtime sensor monitoring screen

In case of all settings have been entered correctly, administrators can check the UPS's current status in real time by using the UPS monitor. Although the representation may differ depending on the manufacturer and model, some data such as the selected model will be shown:





Overview – the color code

UPS:  Test In Progress	BACS:  Communications Lost	GSM Modem:  Communications Lost
Sensor:  OK		



The upper status bar offers an overview of all connected devices. The color scheme is based on the typical colors of a traffic light. In general, a distinction is made between 4 different system states, which are correspondingly highlighted with a color code. What exactly applies is described in a short text next to the marker.

The colors of the markers will change as followed:

1. *Initialization phase of devices and services*

	The services are currently starting and search for devices. This notice can be seen both, when commissioning additional modules or when restarting the CS141 for some reasons, as an example a reboot caused by a firmware update.
	The initialization phase has been completed and no device was found. A blue marker means that the connection was never established. Please check wiring and operating state of the according devices. In some cases, you also may check your configuration work.

2. *Notifications and alarm conditions during normal operating mode*

	Devices and alarms are within the specified parameters, everything OK.
	There is an event that deviates from normal operation and should be observed, e.g. A running UPS test, temperatures reach remarkable values, initialization of devices and services is carried out after a restart, etc.
	A device reports an alarm state or the conditions for a configured alarm behavior have been met. Communication Lost with a red marker means that an existing connection to a device has broken down.

UPS functions

For this configuration step, navigate to the following menu:

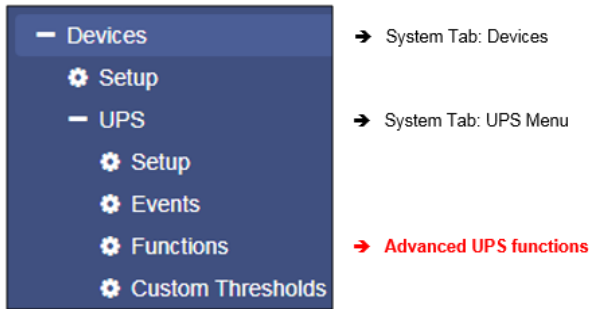

The UPS Functions menu contains options to perform tests sequences or to configure build-in special functions a UPS may provide. They are tailored to the UPS model used to represent its functionality. As a consequence, the functions displayed for this menu item can vary - some UPSs only allow the on / off state as well as a single test-button, others provide more functionality.

The following functions represent typical menu entries:

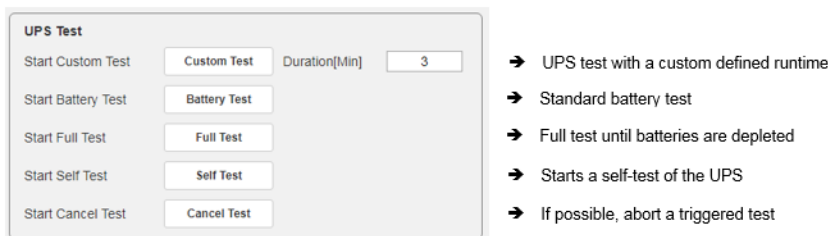

Custom Test

The Custom Test is an on-battery function test using a self-defined time in minutes.

Battery Test

The battery test checks whether the UPS works properly and the batteries take over. This test usually takes about 15 seconds. This test will not show how long the batteries will be able to take over.

Full Test

The Full Test will test the batteries until they are depleted. This test can take a long time depending on power and load. The CS141 also accurately measures and determines the runtime under load. Please note UPS systems require stable load of at least 25% to perform a full test.

Self test

With this test, the UPS checks its own electrical functionality

Note:

In some cases, a UPS command may seem to fail or an error message may appear. This behavior is based on the fact a UPS receives and confirms a command, but without doing it until pre-conditions are fulfilled. As an example, there must be a minimum charge for a particular battery test - otherwise the UPS returns an error message as a result. This result will be logged accordingly as "error". In reverse cases, it is possible the UPS sends a positive feedback despite errors but indicates an error on the front display itself.

Due to these facts in sometimes the behavior of a UPS system is unique and for some cases unfortunately not predictable.

UPS Control settings

Depending on design and model, some UPS systems support additional functions to be used for verifying the performance of the UPS. The scope of functionality and configuration possibilities varies considerably and depends on both the manufacturer as well as the model to be used.

Typical functions a UPS may provide:

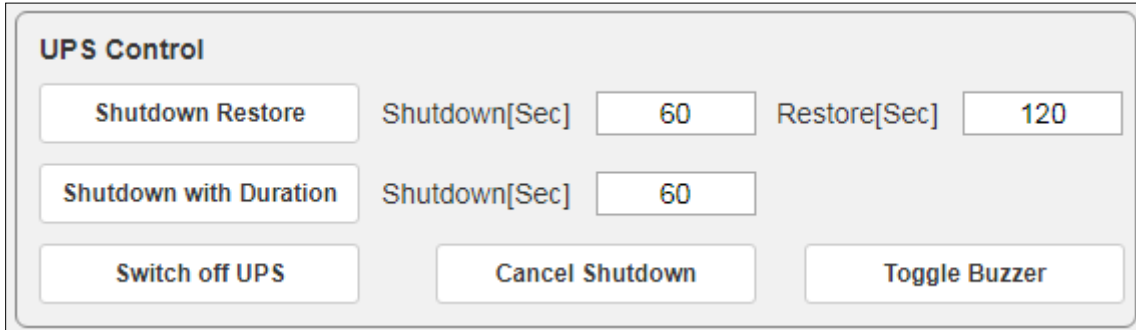

Switchable output

Depending on the design, some UPS systems support switchable output ports.

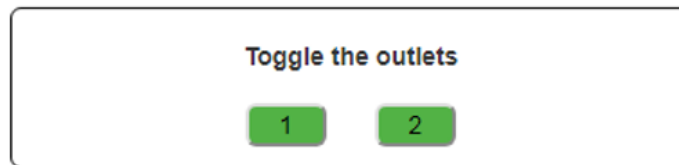

Note:

Depending on the performance class, UPS systems are equipped differently. Due to this fact, the scope of functions varies.

Event handling

For this configuration step, navigate to the following menu:

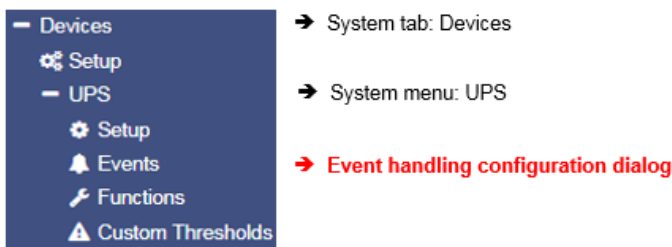

There are many incidents that may require the operation of a UPS. In other cases, devices connected to the UPS may be harmed by different events.

These events could be as an example

- the failure of the main power supply,
- the restoration of the main power supply,
- a defect from inside the UPS prevents taking over to autonomous battery mode
- batteries are depleted and main power is still missing

As a full-fledged manager, the CS141 has the ability to respond to incidents independently, inform responsible personal and even manage event chains to provide a complete shutdown solution inside complex interdependent networks.

What is the intention of a jobs for an event?

System events are highly dependent on the UPS model to be used and vary in both - designation as well as abundance of possibilities. Furthermore, administrators will find interesting conceptual issues according to the interplay of events and counter-events:

An event receives an action, a job. This job will be executed when the event occurs. These jobs differ in central role as well as its direct function:

- *Information*

These jobs can be executed as often as desired and only fulfill the purpose of the information. Depending on the configuration, information can be sent once or cyclically as long as an event is pending - the nature of the event does not matter. If the situation changes and the event does not come to fruition, an according job will not continue.

- *Action*

These jobs are designed to switch, trigger, start emergency routines, etc. These jobs are triggered as soon as an event occurs. They differ from information jobs due to the fact administrators have to terminate these jobs by using corresponding counter-rotating jobs. In some cases, there are counter-events to be used, others need to be configured manually.

Note:

It is important to understand the difference

As long as a power failure occurs, a mail with log files is appended to should be sent every 5 minutes. Once the power failure is eliminated, no more email is written. On the other hand, a job to close potential-free contact as soon as a power failure is detected is executed. This cannot be reverted - even if the main power comes back, the contact remains in closed position. If a warning light is switched via this contact, it would light up until this contact is deliberately opened. A counter-job is needed in case of main power returns.

The following example shows why it is important to understand the difference:

If the temperature sensor measures critical temperatures, the CS141 will send e-mails and simultaneously close the contact of an air conditioner. As soon as the temperature drops below the critical level, CS141 stops sending e-mails - but the air conditioner needs to run until the temperature has returned to normal condition. This will not work if the contact automatically opens in case of critical temperature is no longer given:

You need to use an active job to switch off the air conditioning system as soon as a certain temperature has been reached.

It becomes problematic if a power failure causes two UPS systems running on separated power input circuits to send a server shutdown command:

As soon as both systems send a valid shutdown command, the server shuts down immediately - even if both UPS systems report a power failure time-separated. If they do not cancel the shutdown command after their respective individual problems were resolved, the server will shut down due the fact, both UPS systems seems to report problems.

Event handling: Defining a job

The jobs can be configured at any time.

In order to test a job, two conditions need to be adjusted according to the job:

1. Jobs according to e-mails require valid e-mail account data
2. Jobs based on the TCP / IP settings require a valid network configuration





Before continuing configuration ensure all access data are available for configuration, network settings are correct, and that the CS141 is in the regular operating mode inside your network.

Managing jobs



Under Devices, open the UPS submenu and go to Events.

Please note that both the functions as well as designation will differ by usage of different UPS systems.

These are the icons the CS141 provides:

-  → Open /close tables
-  →
-  → Edit an existing job
-  → Test an existing job

Symbols providing two functions:

-  → delete
-  → Checkbox to select multiple jobs or events
-  → Add a job

Note:











Dual function symbols have two different meanings:
Depending on where you serve them, they refer to ALL events or to a specific event or job. This dual functionality allows you to add a specific event to specific or all system events without the need of entering each job individually.

Setting up a job

Managing jobs for a system event always follows the same rules - as an example, the following system events are selected:

>	<input type="checkbox"/>	+		Powerfail	3	1	0	1	0
>	<input type="checkbox"/>	+		Power restored	3	1	0	1	0

Select > to open the job table:

-	<input type="checkbox"/>	+		Powerfail	3	1	0	1	0	0	
				Job Type	When	Parameter					
				  	Log	Periodic all 100s, immediately	{ "text": "Powerfail" }				
				  	RCCMD Trap	Once, immediately	{ "text": "Powerfail on #MODEL . Autonomietime #AUTONOMTIME min." }				
				  	E-Mail Trap	Once, immediately	{ }				

For the event Power failure, a total of 3 jobs are already configured. These jobs were loaded as a recommended default configuration when selecting a UPS. To change or remove, just click on the corresponding icon.

The CS141 allows to delete all jobs within a system event:

By doing so, activate the checkbox in the line for power failure and press the symbol for deleting events. After pressing all jobs associated with this one event will be deleted from the list.



Note:

Deleted jobs cannot be retrieved, they must be recreated or restored by using a backup. To prevent accidental deletion, administrators will be prompted to confirm their decision to delete all entries inside an event...

To add a job to the power failure event, press + at the event line. This will trigger the configuration dialog who will guide you through configuration process.

The following jobs are currently available:

Log	Inserts a free definable message into the event log.
Email*	CS141 will send an email.
Email Trap*	CS141 will send Trap Mails
RCCMD Shutdown*	CS141 will transmit a shutdown signal to one or more RCCMD clients.
RCCMD Message*	CS141 will send an RCCMD message to one or more RCCMD clients.
RCCMD Execute*	CS141 will send a command to execute a custom file.
UPS Shutdown***	Turn off UPS
AUX**	CS141 will trigger external relays.
Buzzer**	If a buzzer is connected, CS141 can activate it by using this job.
RCCMD Trap*	CS141 will send an RCCMD trap message.
Send WOL	Wake On LAN - The CS141 will send so-called magic packet to a network device.
Send SMS**	If a GSM modem is connected, CS141 will be able to send SMS.
AUX: Switch Outlets***	As an example, the UPS can be instructed to disconnect the live outlets after a full discharge of the batteries and run a time-delayed release to guarantee a minimum charge of the batteries..
WAKEUP	If two UPS are running in redundancy mode, this custom RCCMD command can be used to withdraw an RCCMD shutdown command

* Additional software may be necessary.

** This feature may require additional equipment and accessories.

*** This function is only available to a limited extent: although some UPS systems fundamentally support the functionality, they respond very differently to this job:

Some UPS systems accept and confirm this job, but ultimately decide themselves about execution and timing.

Tutorial: Remote Command

Conditions to be met for using this function::

1. The sending device needs at least firmware 2.12
2. The receiving device must support the respective function and be able to provide the required peripheral devices.

"Remote Command" is a very powerful tool that allows all devices of the CS141 product family to exchange information directly and communicate to contact-controlled management systems, enabling extensive networking within building management systems and to exchange and respond to a switching status directly via the network:

A CS141 BSC, as an example, does not provide external interfaces

With Remote Command, it is now possible to program the relays of a SITEMANAGER, the outputs of a SENSORMANAGER or CON_R_AUX4 directly and thus automate a complex control system - all devices are now capable to coordinate each other via LAN and contact wires and thus even most complex environmental control and monitoring is possible.

Parameter	
Host	<input type="text" value="hostname or IP addr"/>
Port	<input type="text" value="443"/>
Verify	<input checked="" type="checkbox"/>
Certificate	
User	<input type="text" value="user"/>
Password	<input type="text" value="Password"/>
	<input type="checkbox"/> Show Password
Remote Command	<input type="text" value="AUX"/>
Port Number	<input type="text" value="AUX 1"/>
Command	<input type="text" value="Set High (On)"/>

How exactly does this job work?

With the command "Remote Command" the CS141 / BACS in the basically can now be directly connected via LAN CS141 - Access devices and send them accordingly e.g. send an SMS, open / close contacts, switch relays, etc.

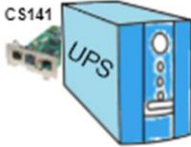
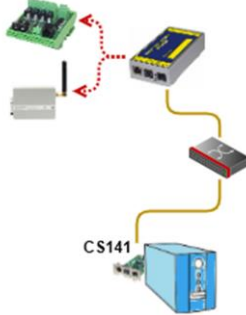
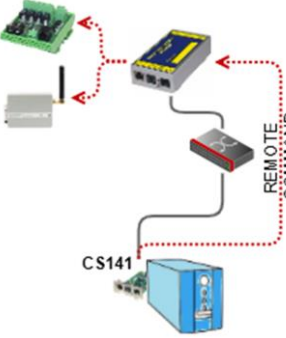
 <p><i>Popular problem:</i></p> <p>The UPS and thus the CS141 are isolated in the middle of the dead zone in the basement. That's actually not uncommon in case of a UPS or battery system. Although you often still have access via LAN, communication becomes difficult with contact-controlled building management systems.</p>	 <p>However, there are other CS141s in the building, eg with a ON_R_AUX_4 or even SITEMANAGER, that can manage outputs and a GSM modem. Let's say, luckily both devices are connected via the LAN.</p>	 <p>With "Remote Command", a CS141 / BACS can communicate with any other CS141 device and program interface modules directly. There is no blind spot a CS141 cannot communicate</p>
---	---	--

Actions are reserved for administrators: requirements and reservation clauses

The operating principle illustrates the power of this function is: There are numerous possibilities for integration into existing building management systems including modern server infrastructures. Accordingly, this job can also be configured accordingly:

Parameter	
Host	<input type="text" value="hostname or IP address"/>
Port	<input type="text" value="443"/>
Verify Certificate	<input checked="" type="checkbox"/>
User	<input type="text" value="user"/>
Password	<input type="text" value="Password"/>
	<input type="checkbox"/> Show Password
Remote Command	<input type="text" value="AUX"/>
Port Number	<input type="text" value="AUX 1"/>
Command	<input type="text" value="Set High (On)"/>

- ➔ Target IP / hostname of the device that shall trigger an action
- ➔ Communication port for this job
- ➔ Is the certificate of the sender valid?
- ➔ Enter user and password: Only administrative users are allowed to use this job!
- ➔ Show password
- ➔ Define the function you want to trigger
- ➔ Additional parameters, depending on the function

In this screenshot, you can see that Outlet 1 has been switched in this case:

The target device will naturally set the AUX output to "1 (ON)" accordingly, and then execute the jobs assigned to this local system event.

Even this little job provides many features for your network, eg:

1. inform a contact-controlled management system without pulling new contact wires.
2. configure to this event a complete autonomic reaction behaviour, e.g. briefly close output 2, then reset both contacts to their original state, etc.
3. In companion with RCCMD, create internal message Jobs to display pop-up windows with system instructions for administrators.
4. trigger automatic scripts and initiate preparatory server shutdown measures.
5. And do much more...

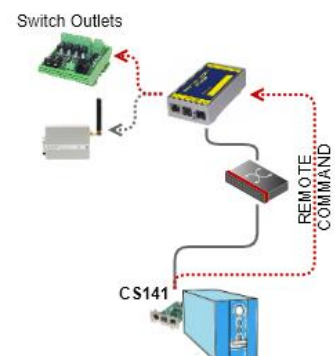

Note: Any number of individual actions possible

Each CS141 is capable to contact a various number of other devices of the CS141 product family, and thus trigger actions accordingly. Du to this fact, a CS141 provides to combine LAN and contact - based communication methods.

Tutorial: WOL - The „Magic Packet “

What is the „Magic Packet “?

In principle, the "Magic Packet" is a standardized data package containing 4x FF. This data packet is sent directly to the MAC address of a network card. Most modern network interface cards support this basic function natively, but for more network functionality, an operating system is usually mandatory.

Preconditions to be met for setting up a working WOL system restart:

1. Depending on your network configuration, these ports must be open:

Port 7 – UDP
Port 9 – UDP

2. Operating system and/or the hardware of the according target system must be configured to handle WOL-Signals.

Where is the configuration made on the target system?

In principle, there are two basic scenarios:

Configuration work at the operating system

It is possible to specify whether the operating system allows the a "Magic Packet". If allowed, the operating system can be configured to wake up from hibernation mode. The condition is, however, that the operating system is still running at this point, albeit in some kind of deep sleep mode. If the hardware is turned off physically or a complete power loss happens, the hibernation state of the operating system is gone with the power loss.

Configuration work at the BIOS

In the BIOS setting, the reception of the "Magic Packet" is controlled directly via hardware settings - the network card itself manages the reception and starts the hardware. However, as soon as the computer is just in a hibernation mode, the hardware is not responsible to manage a restart - the hibernated operating system has to trigger and manage the wake up. The network card will only start the hardware via WOL in case of a complete power loss during hibernation mode.

Note:

Virtualized systems are a little bit awkward, because the network interfaces are normally virtualized: The Possibility to pass a WOL signal through a physical network interface in order to start a virtual machine depends on the scope of functions the virtualization solution itself provides. If in doubt, please contact the technical support of the corresponding virtualization solution.

OK, ... but which settings must be carried out?

That depends on what you want to achieve.

If your (physical) computer normally needs to wake up from hibernation mode, the network options of the operating system must be configured to manage WOL packets. When the computer is usually switched off, powering up is managed by the hardware. You need to configure the hardware:

If you want to ensure an identical result in both cases, then it is recommended to carry out both settings accordingly

3. *Setting up the CS141*

All devices of the CS141 family use colons as separators for the MAC address values.:

Example:

Job	Send WOL ▼
Parameter	
Port	9
MAC-Address	00:AC:0F:FE:00:00
Password	

Create multiple single jobs to power up different devices via WOL. It is not possible to set up one job with different MAC addresses.

Note:

Since the WOL signal is sent to the MAC address of a network card, the IP address and the subnet mask do not matter, as they are used by higher system authorities. These higher network authorities must be up and running first. The port only becomes interesting in case of the WOL signal has to be routed across networks by a router to other network nodes. Usually port 7 or port 9 is used for this function, but you have to keep in mind that the ports are managed by the system administrator of the network and can be freely adapted to his preferences and security approvals. In other cases, it is possible that the network hardware may use a hard coded port number and blocks all other signals as a kind of intrusion. In case of your WOL-Signal does not work, check the local IT infrastructure if the WOL signal was filtered or blocked by other network devices.

UPS Shutdown definitionWhy is the job UPS shutdown a little bit tricky?

A UPS performs a UPS shutdown to protect the batteries from a deep discharge. The UPS is physically shut down and turned off. The time when a UPS performs this action or how it reacts to a triggered action by scheduler or via UPS functions already varies even between the models within a manufacturer - in addition, each manufacturer uses its own definitions for to protect batteries. But due to the fact the UPS has been physically turned off, counter events cannot be configured.

Configuring UPS Shutdown

Job	UPS Shutdown	→ Choose the job
Parameter		
Shutdown Time	<input type="text"/>	→ Time delay until system shutdown
Restore Time	<input type="text"/>	→ Time delay until system restart
Type	1	→ Toggle shutdown type

Shutdown time in seconds

Defines how long the UPS should maintain operation before shutting down itself.

Restore time in seconds

When the main power supply is restored, the UPS waits for the preset value in seconds until it starts up again.

Type

With this setting the UPS will be turned off or turn on. Two different settings are possible:

- | | |
|---|---|
| 1 | The UPS switches off the outputs but remains in operation mode. |
| 2 | The UPS shuts down and turns off completely until the main power is restored. |

How to use the job UPS Shutdown

This job cannot map both settings together.
Depending on the desired operation modes, at least two jobs are required.

As an example, it is possible to use different jobs to complete the following sequence:

- Switch off outputs after 3 minutes
- Shutdown the UPS after 4 minutes
- Turn on the UPS 2 minutes after the main power supply is restored
- Activate the outputs 15 minutes later

Note that the shutdown time and the restore time must be correctly nested for both jobs.

In this case, enter either a 1 or a 2 depending on the desired event.

Search and display jobs

Event	Jobs	Log	E-Mail	E-Mail Trap	RCCMD Shutdown	RCCMD Message	RCCMD
<input type="text" value="contains..."/>	<input type="text"/>						

The Search function is a quick method to find jobs configured within events.
The CS141 provides two basic options:

Event contains...

Search for a UPS event. By typing a part of an event all events according to the text fragment are listed.

Jobs

Lists events containing a number of jobs defined by this value. As an example, if you want to know how many events contain 3 jobs, enter 3. All events containing this number of jobs will be listed.

Configure a Job

Press **+** at an event to open the job configuration dialog.

The screenshot shows a dialog box with a label 'Job' on the left and a dropdown menu on the right. The dropdown menu is currently set to 'Log' and has a downward arrow on its right side.

Different jobs provide different parameters to be configured

Example 1: Log – Enter the text CS141 shows at Event Log?

The screenshot shows a configuration dialog for the 'Log' job. It has a title bar 'Parameter' and a single input field labeled 'Text'.

Example 2: RCCMD execute – Due to the fact RCCMD needs IP address data, the parameters will change.

The screenshot shows a configuration dialog for the 'RCCMD execute' job. It has a title bar 'Parameter' and three input fields: 'IP' with a 'Broadcast' checkbox, 'Port' with the value '6003', and 'Command' with a vertical bar '|'.

Note:

The parameters adapt dynamically to fit to the according job. If the job type does not support a parameter, it will not be provided for configuration

Wildcard parameters: Additional information about the system state

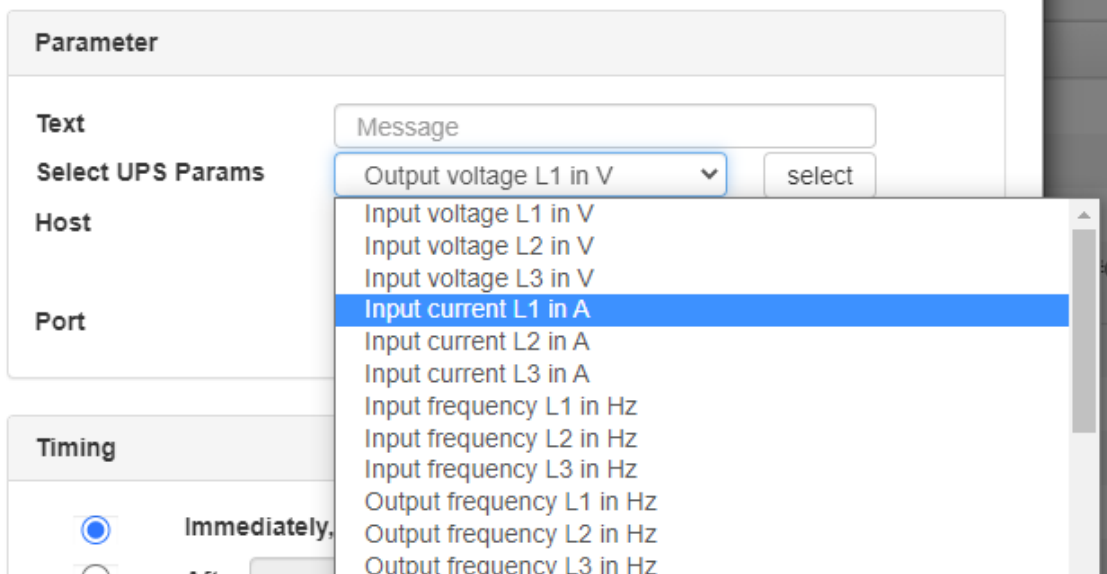

Choose the desired status information parameter and press select.

The CS141 will automatically insert the corresponding function in the text field. Select as many parameters as wanted one after the other. In case of a corresponding function cannot be served because the according function is not supported by the UPS, the message will show NA for not available.

Job timing

The CS141 provides many system events a job can be assigned to. Some jobs allow to configure advanced timing:

Immediately, once	as soon as an event happens, this job is executed at once and not repeated.
After XXX seconds:	The CS141 will wait a pre-defined time in seconds and then execute the job. If the event is no longer active before time is up, the job will not be executed.
Repeat all XXX seconds:	The job is repeated cyclically until the event no longer is no longer active.
After XXX seconds on battery:	The event forces the UPS will to switch to autonomous mode. The job will be executed if the UPS remains a pre-defined time in this state. For example, if 300 seconds are set, this job will only be executed if the UPS operates in autonomous reaches 300 seconds.
At XXX seconds remaining time:	The job is executed when the remaining UPS operating time is reached or undershot. Note based on the current load this time value becomes flexible.

Time management of jobs

The time management of jobs to be performed is difficult since one has to distinguish conceptually between two different points of view. The following example according to the event power failure illustrates the differences:

In case of a power outage, the UPS will take over power and protect the servers until ...

1. The batteries are depleted
2. Main power is available again

As soon as the UPS runs into autonomous mode, it will start two different timers:

A linearly advancing time in seconds starting at 0.

If a job is to be executed after 45 seconds, it will only be executed if the event is pending for at least 45 seconds. If the event is terminated before consequently the job is not executed.

A relative clock that counts backwards depending on the connected load currently used.

This becomes tricky if the UPS will operate with a load of 100%

If some of the machines connected to the UPS will be shut down after 3 minutes and cause the load to drop to 50%, it will take effect this way: Because of dropping load, the clock would jump from 4 minutes to 7.5 minutes.

Both methods to count come with specific advantages and disadvantages:

The first counter gives a clear time window to sequent jobs but ignores the actual remaining time of the UPS:

If there are several small power failures in a row, a server shutdown would not work with a time delay of 5 minutes if battery power is left to ensure power a maximum of 4 minutes.

The second counter is difficult to calculate and varies depending to the current load. As a consequence, there may be a time lag to execute configured tasks: 5 minutes remaining time cannot be achieved over a longer period of time, if the circumstances increase the remaining time - for example some systems will be shut down at 7 minutes remaining time. On the other hand, a predetermined Sequence of events can get mixed up as soon as the circumstances correct UPS uptime down and cause normally sequentially configured jobs simultaneously getting triggered.

Note:
Basically, a shutdown using remaining time is useful, since the actually existing battery charge can be included. If a special order must be observed for jobs, it makes sense to use the linearly forwarding clock for scheduling.

Adding jobs to several events

Under circumstances, a configuration requires multiple events be assigned the same job. To assign these jobs to more than one event, it is possible to select each event individually and to define this job.

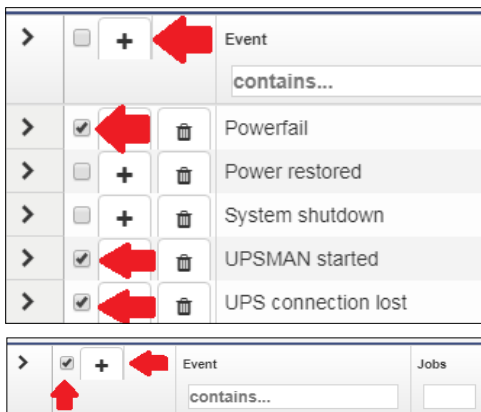

To speed up the process select the events that should receive the same job. Then click on the upper +.

By doing so, the same job is created inside the selected events.

Activating the checkbox at the top row will advise the CS141 to add a job to all events. To start the job configuration dialog, click +.

Delete a job

If system events are no longer used inside a configuration, administrators should remove these jobs to prevent unexpected incidents.:

- Delete a job

Open event tab by clicking >



Choose the job you want to do delete and press the small trash icon. The job will be deleted immediately.

- Delete all jobs within an event

		Powerfail	3	1
		Job Type	When	
		Log	Periodic all 100s, immediately	
		RCCMD Trap	Once, immediately	

To delete all jobs inside an event, choose the checkbox of the desired event tab. Then press the small trash icon. By doing so, all jobs listed inside this event will be deleted immediately. accidentally deleted jobs need to be configured again.

Note:

The CS141 allows to add, edit and delete any job. The event list itself is hard-coded and depends to the UPS you are using. Events cannot be deleted or edited by any user.

Counter events

Some jobs must be explicitly withdrawn when an adverse event occurs:

- Information of responsible persons / "all-clears"
- Further actions
- Advised server shut downs
- ...

The configuration of a counter job follows the same pattern as the creation of a job. According to this context, for some jobs time management becomes a significant role:

Since the UPS comes back from autonomous mode to normal mode, it will take amount of time to recharge the batteries in order to run all jobs as configured.

Example scenario:

Due to a power failure the UPS has switched to autonomous mode and will hold all connected devices for 60 minutes at 100% load.

With 30 minutes remaining, many computers automatically shut down, reducing the load to 20%.

The remaining time will be corrected upwards accordingly.

Since all systems are shut down only after 5 minutes of remaining time, but the power failure at 6 minutes has been eliminated, normality returns.

In this case, the CS141 can restart all computers shut down to protect the remaining time via Wake on LAN (WOL) - this absolutely useful for automated restart of networks after power failure.

In this scenario, if all connected computers were to be restarted automatically, this means that the UPS could withstand 20% load for 6 minutes at the next power failure - but 100% load must be delivered. Since this cannot work, the WOL packet must be delayed in time to give the UPS the ability to charge a minimum of batteries.

Note:

It is possible to create up to 50 jobs per event. In some cases, individual jobs may contradict each other or undo desired jobs accidentally by using counter jobs.

Custom Thresholds

For this configuration step, proceed to the following menus:

- Devices	→ System tab: Devices
⚙️ Setup	
- UPS	→ System menu: UPS
⚙️ Setup	
🔔 Events	→ Event handling configuration dialog
🔧 Functions	
⚠️ Custom Thresholds	→ Custom defined system event configuration dialog

In some cases, UPS models allow you to customize the limits for some UPS-specific events.

The CS141 supports these features if the UPS provides such an option. Otherwise you will be informed by a corresponding system message.

The configuration is done via two menus:

- Custom Thresholds to define and customize settings
- vent menu to assign jobs

		Min		Max	
<input type="checkbox"/> Battery Voltage	out of range	0	V	0	V
<input type="checkbox"/> Input voltage P-N	out of range	0	V	0	V
<input type="checkbox"/> UPS Temperature	out of range	0	°C	0	°C
<input type="checkbox"/> UPS Autonomy	less than ▼	0	m		
<input type="checkbox"/> Battery Charge	less than ▼	0	%		
<input type="checkbox"/> Output Load	greater than ▼	0	%		
<input type="checkbox"/> Battery Symmetry Pos./Neg.	greater than ▼	0	V		
<input type="checkbox"/> Seconds on Battery	greater than ▼	0	s		

>	<input type="checkbox"/>	+	🗑️	Battery voltage Threshold Warning Low On
>	<input type="checkbox"/>	+	🗑️	Battery voltage Threshold Warning Low Off
>	<input type="checkbox"/>	+	🗑️	Battery voltage Threshold Warning High On

Differences between Warning and Alarm Levels

The Custom Thresholds are identical for Warning and Alarm Levels - but they are listed separately in the UPS event menu. Furthermore, they will be listed inside log files as a Warning or Alarm.

This will allow to configure warning and alarm behavior containing different values.

These conditions can be set up:

- out of range** the event – regardless of alarm or warning - is triggered if the measured value falls below or exceeds entered values.
- less than** the event - regardless of alarm or warning - is triggered if the measured value falls below configured values.
- greater than** the event - regardless of alarm or warning - is triggered if measured value exceeds configured values.

Example: How to configure UPS temperature Custom Thresholds

Electrical devices operate safely between a minimum and a maximum temperature grade. Running a device exceeding these conditions may cause issues. These issues may vary starting from simple defects up to acute fire hazards.

In order to be able to intervene in time, therefore, a predetermined temperature value must be compared with the measured temperatures.

As an example, the manufacturer of a device specifies the "safe operating temperature" between + 5 ° C and + 39 ° C:

The CS141 can be configured to warn if these values will be exceeded - the condition out of range first defines the safe temperature range.

As mentioned, two menus are required to configure Custom Thresholds:

- Custom Thresholds:

The first setting is made under Custom Thresholds where the appropriate values are set.

Warning Levels			
		Min	Max
<input type="checkbox"/> Battery Voltage	out of range	<input type="text" value="0"/> V	<input type="text" value="0"/> V
<input type="checkbox"/> Input voltage P-N	out of range	<input type="text" value="0"/> V	<input type="text" value="0"/> V
<input checked="" type="checkbox"/> UPS Temperature	out of range	<input type="text" value="10"/> °C	<input type="text" value="34"/> °C
<input type="checkbox"/> UPS Autonomy	less than	<input type="text" value="0"/> m	

Enabling the checkbox UPS Temperature will include measuring values according to the UPS. For the argument out of range you need to specify both - the lowest temperature value and the highest temperature value.

Note:

Since this is the warning, it should be sent before reaching critical values.

Due to the fact the minimum of + 5 ° C and a maximum of + 39 ° C is predefined by manufacturer, the values for warning levels must be corrected accordingly. In this example the decision is made to use 5°C:

Min: 10°C
Max: 34°C

Save your entries and move to the next menu:

- USP events

Search for temperature threshold entries to be found at UPS events. Unlike the Custom Thresholds menu, each Threshold is displayed as regular system events and shows all possible states:

>	<input type="checkbox"/>	+	<input type="checkbox"/>	UPS Temperature Threshold Warning Low On	1	1	0	0	0
>	<input type="checkbox"/>	+	<input type="checkbox"/>	UPS Temperature Threshold Warning Low Off	1	1	0	0	0
>	<input type="checkbox"/>	+	<input type="checkbox"/>	UPS Temperature Threshold Warning High On	1	1	0	0	0
>	<input type="checkbox"/>	+	<input type="checkbox"/>	UPS Temperature Threshold Warning High Off	1	1	0	0	0

Since Custom Thresholds can be configured like regular UPS events, all jobs are available. If necessary, counter jobs can be defined according to temperature.

Setting up Alarm Levels

The alarm levels represent an escalation level and, if necessary, should trigger emergency measures, the values must be adjusted accordingly to warning levels.

>	<input type="checkbox"/>	+	<input type="checkbox"/>	UPS Temperature Threshold Alarm Low On	1	1	0	0	0
>	<input type="checkbox"/>	+	<input type="checkbox"/>	UPS Temperature Threshold Alarm Low Off	1	1	0	0	0
>	<input type="checkbox"/>	+	<input type="checkbox"/>	UPS Temperature Threshold Alarm High On	1	1	0	0	0
>	<input type="checkbox"/>	+	<input type="checkbox"/>	UPS Temperature Threshold Alarm High Off	1	1	0	0	0

Please note, since the condition for an alarm is fulfilled in addition to existing warning levels, configured jobs can be executed in parallel, overlap or even contradict or cancel each other out.

Exemplary excerpt: Custom Thresholds

This excerpt is an example. Depending on UPS model and manufacturer, this list will vary in naming as well as functionality differs. The sample list shown below shows the custom threshold list of a XANTO 2000R from the manufacturer Online:

		Min		Max	
<input type="checkbox"/> Battery Voltage	out of range	0	V	0	V
<input type="checkbox"/> Input voltage P-N	out of range	0	V	0	V
<input type="checkbox"/> UPS Temperature	out of range	0	°C	0	°C
<input type="checkbox"/> UPS Autonomy	less than	0	m		
<input type="checkbox"/> Battery Charge	less than	0	%		
<input type="checkbox"/> Output Load	less than	0	%		
<input type="checkbox"/> Battery Symmetry Pos./Neg.	greater than	0	V		
<input type="checkbox"/> Seconds on Battery	greater than	0	s		

Battery Voltage *out of range* XX V – XX V

Batteries are sensitive to voltages, high voltages and deep discharges can permanently damage them. This value can be used to warn in good time as the entered range is left.

Input voltage P-N *out of range* XX V – XX V

on request some UPS systems offer on measurement data of the input voltage. This value can be used to implement an alarm response to voltage dips or overvoltage on main power input

UPS Temperature *out of range* XX°C – XX °C

Some UPS systems provide internal temperature sensors to measure device temperature values. This value can be used to define an additional alarm behavior based on the temperature values that the UPS supplies.

UPS Autonomy *less than* XX m

in some cases, it may be useful to define additional alarm behavior about the remaining time a UPS ensure emergency power in autonomous mode - as an example if defined jobs depends on a configured time delay and due to several short power outages in a row Time is available: An emergency behavior scenario could be an alarm shutdown of systems.

Battery Charge *less than* XX %

If a UPS comes back from autonomous operation to normal mode, it will automatically start to recharge the batteries. This may last some time. In case of several short power failures in sequence, an additional early warning behavior can be defined using this value.

Output Load *less than* XX %

Some UPS systems provide real-time measurements of the current load. In case of the UPS switches to autonomy mode, normally non-vital systems will be shut down as soon as possible. Due to the fact the output load differs if systems will be shut down, this value can be useful for confirmation or advisory behavior.

Battery Symmetry Pos./Neg. *greater than*

Some UPS systems use the positive and the negative half wave of AC to charge batteries. This setting defines the alarm behavior if the positive battery string and the negative battery string are not loaded evenly.

Seconds on Battery *greater than* XX s

in some cases, a voltage drop is recorded, for example in case of large industrial plants are put into operation. In some cases, it may happen that a UPS switches to autonomous mode for one or several seconds. With this value an additional warning could be realized to verify a "genuine autonomy case".

Note:

Pay close attention to the arguments associated with the thresholds:

Greater than, less than, in range, out of range - since arguments are taken literally as a condition, the warning and alarm behavior will be done according to the configuration:

As an example, if the output load warning is less than 67%, it will also issue a warning if it drops to 43%. On the other hand, 67% will not warn due to the fact the value has to be below 67%

Tutorial: Custom Thresholds

Problem description

Although the CS141 recognizes the UPS correctly, contactors are to be activated via potential-free contacts. This shall switch off external devices as soon as the charge of the batteries drops below a configured value.

This configuration can be realized indirectly:

If a CON_R_AUX4 is connected to CS141, the potential-free outputs can be used to control the contactors - it is possible to switch through (ON) and block (OFF). This will allow to implement the control of the contactors without tricky issues.

It will be difficult if the UPS does not offer suitable events:

As a consequence, these events are not displayed inside the UPS event menu. Using Custom Thresholds will allow this configuration:

The key to this configuration is the fact this function depicts a user definable job as a UPS event:

Setting 71% for Warning Levels and 61% for Alarm Levels, you can subsequently assign appropriate behavior in the UPS events:

- if the battery charge drops to 70%, the first devices are switched off.
- If the battery charge drops to 60%, the next devices are turned off. The counter events are set to Warning OFF or Alarm Off.

As the batteries are charging, the devices should start after battery charge reaches similar values for shutdown.

- From 61% the first device list will be switched on
- From 71% the second device list will be switched on.

Since there is no AND connection to the Power Fail, there are basically two possibilities to run these jobs:

1. Once
2. Repeat as long as the event is active

Note you have a difference of 1% between ON and OFF. Due to the fact the value needs to drop below the values, it is technically not possible to switch exactly ON and OFF at 70% or 60%. A decision is needed whether you wish to switch ON the devices at 60/70% or off

You need to define your jobs exactly:

Turning off the same devices 70% and to on position at 61% could cause conflicts between events and jobs, devices should therefore be consistently configured separately

What will happen between 0% – 71%

Depending on the configuration, independent to any power fail the devices will stay off, shutdown or restart between 0% and 71% battery charge. Above 71% the devices will run as long as no power fail will cause the battery charge to drop at 70%. Since the current load has no influence on the percentage of battery load, the flexible remaining time does not affect this setting. The percentages of the current battery charge are basically used.

Note:

A detailed description of the CON_R_AUX4 can be found at chapter *Sensors*

CS141 as RCCMD Server device

Ever heard something about RCCMD?

RCCMD (Remote Console Command) is the world's most successful shutdown solution for heterogeneous networks and is the best method to ensure initiating multiple messages and shutdown sequences. The solution integrates even the UPS to set up an all-in-one monitoring and messaging solution:

The RCCMD clients listen on port 6003 for incoming messages of RCCMD server module. This module is a general part of

- UPSMAN software
- CS121

The screenshot shows two configuration panels: 'Warning Levels' and 'Alarm Levels'. Each panel has a list of parameters with checkboxes, dropdown menus, and input fields for 'Min' and 'Max' values. In both panels, the 'Battery Charge' parameter is checked and highlighted with a red box. In the 'Warning Levels' panel, it is set to 'less than' 0%. In the 'Alarm Levels' panel, it is also set to 'less than' 0%. Other parameters include Battery Voltage, Input voltage P-N, UPS Temperature, UPS Autonomy, Output Load, Battery Symmetry, and Seconds on Battery.

- CS141
- RCCMD licensed UPS manager.

An RCCMD server controls the RCCMD clients inside networks. The functional scope ranges from monitoring, notifications up to a structured shutdown of a multiple server environment. RCCMD even considers mutual dependencies.

Note:

The RCCMD client is not freeware; a separate license is available and can be obtained worldwide from licensed resellers, OEM partners or directly ordered at www.generex.de. The license itself is unlimited valid, the service scope includes 2 years of free updates from the date of purchase.

Available RCCMD commands for the CS141

As mentioned, CS141 provides an RCCMD server.

The RCCMD commands are defined as jobs via the system events. There are four different categories available:

➔ RCCMD Shutdown

The RCCMD shutdown sends a signal to an RCCMD client. The RCCMD client advice the server to initiate the shutdown sequence.

➔ RCCMD Message

An RCCMD message is a notification text that can be sent to an RCCMD receiver. This text will be displayed on the screen using a separate message box.

➔ RCCMD Execute

If scripts have to be executed in advance for a shutdown, they can be triggered by using the execute command. RCCMD offers not only ready-made commands but also the possibility to start own scripts.

➔ RCCMD Trap

Trap messages are pure informational messages that can be sent to RCCMD clients. The client receives these text messages and displays them inside a pop-up message box.

Note:

An initiated RCCMD shutdown cannot be withdrawn. However, within the RCCMD client, you can also define so-called redundancies and limit IP addresses that are authorized to send an RCCMD signals. By doing so, as an example, two UPSs need to advice a server shutdown. In this case the RCCMD execute *wakeup* will withdraw a server shutdown command.

Configure an RCCMD-Job

RCCMD uses IP addressing to communicate within a network as well as a single network segment.

the following parameters can be adjusted:

Set up IP address for RCCMD

Broadcast messages

Activating this checkbox will trigger an RCCMD broadcast job will be sent. Each RCCMD client installed in this network segment is addressed and responds by shutting down and turning off the computer. There is no distinction between host, virtual machine, single server or workstation.

Limiting IP addressing

A broadcast message is not always the best method for shutting down networks...

To address a particular machine within your network, enter the IP address of the device. In fact, only addressed computer - physically or virtual devices - will receive the RCCMD message.

The CS141 provides both:

creating a single job for each RCCMD client as well as combining several IP addresses to create a device group job.

For several IP addresses, please ensure the correct syntax: 192.168.3.1,192.168.3.18, ...

The IP addresses will be written without space between the individual entries. Otherwise you will receive a corresponding error message.

Note:

Broadcast messages and individual IP addressed or collective addressed messages are mutually exclusive: You can configure the RCCMD client to accept commands by single IP addresses. But the client cannot be configured to differ between a broadcast message and a single message. If you want to shut down devices and device groups first and then send a broadcast, you need to create several jobs with a corresponding time delay.

Port selection

As a default port, RCCMD uses port 6003. The RCCMD client is listening on this port for a valid RCCMD command.

If your RCCMD client has been assigned a different port during installation and configuration, ensure sender and receiver are using the same ports.

Parameter	
IP	<input type="checkbox"/> Broadcast <input type="text" value="192.168.3.1"/>
Port	<input type="text" value="6003"/>

RCCMD Job Timing

The CS141 provides many system events a job can be assigned to. Some jobs allow to configure advanced timing:

Timing	
<input checked="" type="radio"/>	Immediately, once
<input type="radio"/>	After <input type="text"/> seconds
<input type="radio"/>	After <input type="text"/> seconds, repeat all <input type="text"/> seconds
<input type="radio"/>	After <input type="text"/> seconds on Battery
<input type="radio"/>	At <input type="text"/> seconds remaining time

Immediately, once as soon as an event happens, this job is executed at once and not repeated.

After XXX seconds: The CS141 will wait a pre-defined time in seconds and then execute the job. If the event is no longer active before time is up, the job will not be executed.

Repeat all XXX seconds: The job is repeated cyclically until the event no longer is no longer active.

After XXX seconds on battery: The event forces the UPS will to switch to autonomous mode. The job will be executed if the UPS remains a pre-defined time in this state. For example, if 300 seconds are set, this job will only be executed if the UPS operates in autonomous reaches 300 seconds.

At XXX seconds remaining time: The job is executed when the remaining UPS operating time is reached or undershot. Note based on the current load this time value becomes flexible

RCCMD commands

Der RCCMD Shutdown

Parameter	
IP	<input type="checkbox"/> Broadcast <input type="text" value="192.168.3.1"/>
Port	<input type="text" value="6003"/>

The RCCMD shutdown is predefined and advices the addressed RCCMD client to shut down the operating system and turn off the device. Adjustable options include broadcast, sending to individual IP addresses and the port used for RCCMD.

The RCCMD Message

Parameter	
Text	Am Brunnen, vor dem Tore, da steht ein...
IP	<input type="checkbox"/> Broadcast 192.168.3.15
Port	6003

The RCCMD message is a text message that can be defined freely. The text box automatically shifts with the entered text as soon as you reach the right margin. This message will then appear as an alert on a computer the RCCMD client is installed to. RCCMD also displays a warning box on the taskbar.

RCCMD Executes

Parameter	
IP	<input type="checkbox"/> Broadcast 192.168.3.1
Port	6003
Command	hallowelt.bat

An extensive feature within RCCMD is the possibility to run own executables and batch files on a target computer.

This function is useful if scripts have to be executed right before a shutdown is triggered. It is necessary to move the file to be executed to the installation directory of the RCCMD client. Afterwards, the CS141 provides to execute this script directly.

Note:

The screenshot shows the command helloworld.bat has been entered. In this case, the RCCMD client on the PC with the IP address 192.168.3.1 would try to start the file hallowelt.bat directly. If you want to use other directories, you need to specify them accordingly:

C:\skript\helloworld.bat

Please note, it is tricky to run a script on a PC that shall trigger scripts on a third device.

RCCMD Traps

RCCMD traps are pure messages that are intended to inform about the current status of the UPS. A special data packet is generated, which can be received, read and interpreted by the corresponding programme.

Setting up Trap parameters

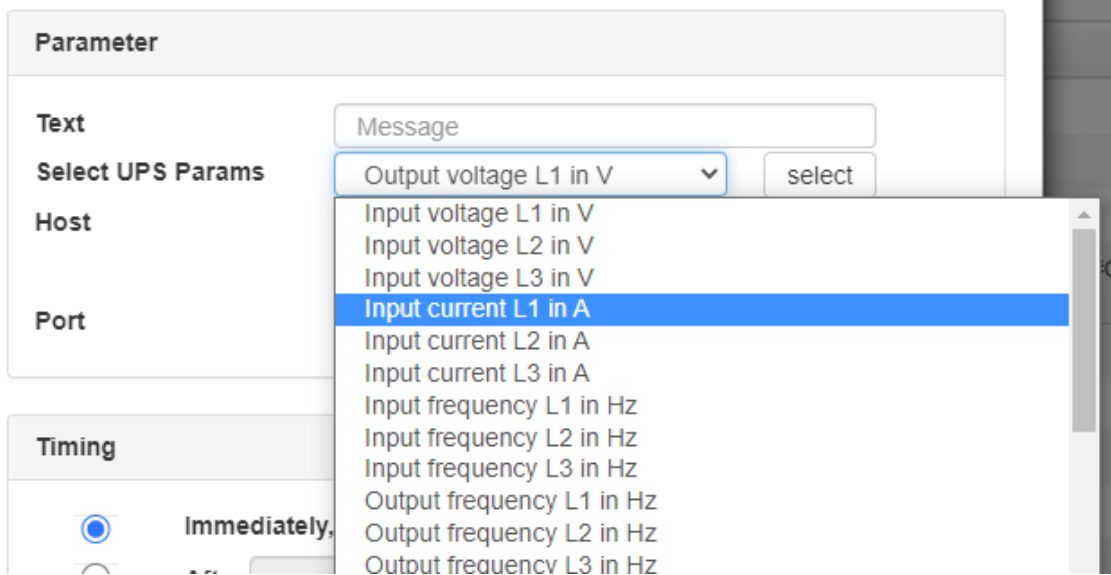

Select the desired parameter and press Select. The CS141 will automatically insert the corresponding function in the text field.

You can select as many parameters as you like one after the other. If the corresponding function cannot be sent because the UPS cannot provide this data or the necessary additional hardware is not connected, the message is inserted accordingly with a NA (Not Available) instead of the value.

Tutorial: Case study about using the event handling

The entire event handling process starts with a crucial question:

What do I want to achieve in the first place?

The problem is that with increasing complexity, correspondingly complex process chains can arise, which - and this is a catch - can also contradict each other. A good example of this would be a computer that simply restarts itself after a malfunction, even if it has been switched off manually. The CS141 can also send a so-called "magic packet", either time-controlled or when certain events have occurred:

Example:

1. In case of the UPS charge is less than 30%, the computers should be switched off.
The configuration would be able to be mapped both, via the Custom Thresholds as well as depending on remaining uptime.
2. If the charge is more than 70%, the computers should be switched on automatically.
This configuration can easily be mapped via the custom thresholds.

The difficulties start the moment a repeat function is set up in the job timing to, for example, 180 seconds. The configuration would change its character accordingly:

As soon as 29% or less charge is in the UPS, all computers would be shut down every 3 minutes - Which is correct, because nothing is supposed to be switched on anymore. The trigger is less than 30%, so mathematically from 29%... If any user actually wants to simply switch on his computer again, the thing simply goes off again.

Conversely, however, it is difficult to have the computers switch on every 3 minutes because there is more than 70% charge, mathematically from 71%. In this case, the CS141 would switch on all affected computers every 3 minutes until the frame condition was no longer fulfilled. The computers would receive the start command via Wake On LAN every 3 minutes at the latest and consequently implement it. For the user in front of the computer, this would be a phenomenon that is very difficult to explain:

He has finished work and presses shutdown on his "Windows". And the computer has the cheek to start up again about 1-3 minutes later at the latest and then runs all night.

From a configuration point of view, item 1 may of course be repeated every 180 seconds, while item 2 must be configured as a one-time event.

The subtle difference between relative and absolute - Planning the shutdown time

To avoid such confusion, it is essential to plan the shutdown and, if necessary, the system start-up accordingly.

		Min	Max
<input type="checkbox"/> Battery voltage	out of range	0 V	0 V
<input type="checkbox"/> UPS Temperature	out of range	0 °C	0 °C
<input type="checkbox"/> Input voltage P-N	out of range	0 V	0 V
<input type="checkbox"/> Seconds on Battery	greater than	0 s	
<input type="checkbox"/> Battery Autonomy	less than	0 m	
<input checked="" type="checkbox"/> Battery charge	less than	30 %	
<input type="checkbox"/> Output load	greater than	0 %	

if in use, batteries lose their charge and if a battery only has 56% charge left after main power returns, well, this is foremost an absolute fact. Another argument is:

- Battery charge less than 30%

When the measured value of the battery charge drops below 30%, the event is pending.

Relative to this, it is possible to calculate how long the batteries would last - to do this, take the current consumption and compare it with the maximum value at 100% capacity.

Simple speaking:

Idealised, we assume that 10 computers generate 100% load and about 1 hour of uptime can be guaranteed:

- 10 computers can be supplied by the UPS for 1 hour
 - o 50% can be count as 30 minutes more /less
 - o 25% can be count as 15 Minuten more /less

And you may say, at about 30% charge, there is about 16 – 20 Minutes remaining uptime in case of all computers stay alive. Now, if you decide at 50% battery charge to switch off 5 computers, the entire calculation will change:

- The battery charge is still at 50%, this is a fact
- In mathematical terms, however, only half would be consumed, which would pull the remaining time available back up by the corresponding value.

In practice, one could now calculate: If all computers were running for half an hour and then you switched off 5 of 10 computers, the remaining computers could still run for about an hour because the load has halved. The battery charge doesn't care in this case: the value continues to fall in any case - just correspondingly slower, because less is consumed.

So if one is planning a shutdown now, one can proceed as follows:

1. After 5 Minutes, switch off computers
2. Switch off computers, of 25 minutes are left
3. At XXX % battery charge, shut down all computers
4. At the UPS Event batteries depleted, at once shut down the entire network

As you can see, there are many scenarios and interesting points of view to carry out a server shutdown timing.

- Maximize the computer usage

After 60 minutes, all computer are off.

- Shutdown depending on priority

The unimportant devices are shut down immediately so that important devices can work longer. Depending on the number of devices shut down, the available runtime changes dynamically.

- Staggered shutdown to carry out a compromise between uptime and possible runtime

The computers are shut down in staggered sequences so that the most important devices are running until the end and the total outage is as low as possible.

In this tutorial, the staggered shutdown is chosen because it best explains the possibilities and options.

Main power fail, Second 0

Die USV übernimmt, es sollten aber alle Nutzer informiert werden:

Since, in this case, an RCCMD client is installed on all computers, select the job RCCMD Message and have it executed at the time "Immediately, one-time execution".

This means: Immediately after the power failure has been detected, all RCCMD clients are informed about the problem via broadcast. (Remember to enable UDP support for RCCMD or a broadcast will not work)

At first, nothing happens because the UPS can supply all devices with power.

Main Power Fail, Minute 5

The unimportant devices shall be shut down

If the power failure has not been removed after 300 seconds, the next job is triggered. A notice for the two computers with the IP addresses 192.168.2.5 and 192.168.2.6 that these devices will be shut down in 3 minutes.

This provides the users enough time to save their data.

If the power failure is over in the next few minutes, this shutdown will not be carried out.

Main Power Fail, Minute 8

The CS141 gets serious:

After 480 seconds or 8 minutes of power fail, the first computers are switched off by RCCMD commands.

The computers receive the signal and shut down the operating systems and then switch off completely. As a consequence, the required power decreases and can be fed to other devices with higher priority, which can thus run longer.

As the administrator knows "his" users internally, he also sets up that the shutdown is repeated every 30 seconds until the end of the power failure. If a user turns his computer back on, it is switched off again as soon as possible after the start.

Part 2 – important devices

The first 10 minutes were allocated, 8 minutes to initiate the shutdown, and 2 minutes to carry out a shutdown. Mathematically, 50 minutes remained. However, since two loads have now been disconnected from the mains, there is less load on the UPS, valuable time that can be added back mathematically. In this case, the CS141 calculates how much time remains for the remaining computers and corrects the value upwards.

The next 3 computers should run for a long time, but not exceed a maximum time:

They are to be shut down as soon as the UPS can only guarantee 30 minutes.

Mathematically: 20 minutes + the time that comes from the units that have already been switched off.

The peculiarity here is in the observation:

The computers in Part 1 were programmed by stopwatch. If the UPS gives up before then, the units will fail.

With the important units we want to prevent this, so we go by the actually determined remaining time:

This counter will work differently - when the power failure occurs, the maximum runtime is determined in relation to the load and then counts down dynamically to 0. If the load changes, the available runtime is dynamically corrected up and down.

In this case:

These devices would normally have 30 minutes before shutting down. Due to the fact, other devices were switched off independently for this job after 10 minutes, the timer is adjusted upwards. As a consequence, these computers will stay alive longer than "30" minutes.

Main Power Fail, after 34/35 Minutes

The next devices were shut down automatically. The remaining battery charge should be about 50%, but only half of the computers are still running. The remaining time is thus corrected upwards again based on the following calculation:

If all devices were now on, the UPS would last 30 minutes.

However, since half of the devices are switched off, half of the value calculated for the entire runtime is corrected upwards again - so there is a (mathematical) total of around 60 minutes available for the remaining devices.

Due to the fact, the whole shutdown thing happened in sequences, the total running time of 60 minutes is stretched far forward:

- 8 - 10 Minutes at full load
- 20-25 minutes because of excluding nonessential computers
- 60 Minutes remaining time for the core computers left

So, the normal case has been stretched from 60 minutes to theoretically over 90 minutes - and after 60 minutes you still have half an hour before things really get critical. Of Course, it must be admitted, that this is an idealized calculation and estimations, but not absolute numbers. But they show what a UPS can do if the configuration is well-done...

Under Powerfail there are 4 different jobs that automatically structure a time-controlled shutdown. These could now theoretically run until the Batteries depleted event (not recommended, is the last sign of life from the UPS) occurs and then a final RCCMD job is configured for the shutdown of the remaining devices.

Why this calculation should be viewed with caution

At first everything looks fine, but what if now there are several power outages lasting no less than 6-7 minutes in total? In this case, this would have fatal effects on time management:

1. The two least important computers would get a warning every time, but never shut down
2. The UPS would run at full load all the time, and then shut down the three more important devices
3. The operating reality does not fit the expectations at 50% UPS charge.

The reason is that one job uses a counter that is reset to 0 each time main power returns, while the other job uses a counter that takes depends on the calculated remaining based on the current load. As soon as the remaining 30 minutes of running time have been reached, the 3 important devices are immediately shut down, while the least important devices were only warned. Taken to the extreme, it can even happen that the two least important computers run to the point of total power failure, stealing valuable minutes and seconds from the core systems that would have taken them to shut down.

Especially in the last few minutes of operation of a UPS, when it reports batteries depleted, it is noticeable whether 5 or 7 devices are running. Batteries depleted means the UPS will switch off to prevent battery damages - it is not clear how long a UPS will grant uptime at this operating state. This is annoying because you are guaranteed to have tried the optimal emergency shutdown and know that it should work, and then this "hiccup" occurs in the main power connection during the last few minutes of operation.

Part 3: Information and backup shutdown

This is where the custom thresholds come into play as a second network for information and shutdown: The custom thresholds do not work with any time information, but with real measured values.

- ➔ If the battery still has 50% charge, then that is a fact...
- ➔ How quickly this 50% is used up is not part of this configuration method.

In principle, the custom thresholds have two states

- On: The conditions are met, the warning or alarm is pending.
- Off: The conditions are not (no longer) met, the warning or alarm is off.

The event is the change between two states:

- It will be switched ON.
- It will be switched OFF.

The key point is that you have to think about how to handle the warning beforehand:

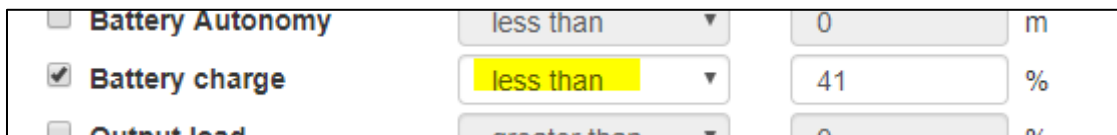

Taking "less than" as an argument, the warning or alarm will be turned on when the value falls below a certain value. Using "greater than" as an argument will turn on the alarm because a value has been exceeded.

We want to prevent the last few minutes of operation of the UPS from only running the computers that are really supposed to be running, so it must be ensured that both unimportant computers are switched off and - because it is possible - also to be informed about the current state of charge

Under Custom Thresholds, enable Battery charge with the argument less than 41%. So as soon as the 40% is displayed, there is an active warning, which is automatically displayed in the UPS events:

-		<input type="checkbox"/>	<input type="checkbox"/>	<input type="checkbox"/>	Battery charge in Percent Threshold Warning On	1	1	0	0	0
					Job Typ	Wann	Parameter			
					Log	Einmal, sofort	{"text": "Information: Battery charge in Percent Threshold Warning On"}			
-		<input type="checkbox"/>	<input type="checkbox"/>	<input type="checkbox"/>	Battery charge in Percent Threshold Warning Off	1	1	0	0	0
					Job Typ	Wann	Parameter			
					Log	Einmal, sofort	{"text": "Information: Battery charge in Percent Threshold Warning Off"}			

Die

The Jobs in a row:

The general warning

First of all, you can create a mail job here:

This is a strong reminder that the 40% charge UPS slowly needs to be taken seriously. This warning is just an information:

The point is that the staff is

- Be informed
- The issue remains traceable
- There is a life sign from the UPS
- Any event logs are backed up

And so forth...

You can also set a log entry here as a job, which indicates that all devices have been shut down correctly, or what is due next, e.g. Log entry: 40% charge remaining in the UPS -starting core system shutdown.

The next job ensures in this case that only what is supposed to run stays alive:

Force immediate shutdown of non-essential computers:

This job is created in order to switch off the unimportant computers at 40% remaining runtime and to divert the available emergency energy to the remaining devices accordingly. In principle, this is the same job that was also triggered with Powerfail, but the conditions differ. This shutdown is triggered restrictively because the battery capacity has dropped to 40% and represents therefore a second shutdown condition:

Condition 1: There must be a power failure for at least 8 minutes. This shutdown instruction will be repeated every 30 seconds until the issue is resolved.

Condition 2: Because the Battery capacity drops to 40%, computers shut down.

If you want to inform your users at this point why this happened, you could first send an RCCMD message with the note:

Power failure, 30 seconds until shutdown and delay the RCCMD shutdown job accordingly, based on the previous model.

The computers classified as more important are shut down over the remaining runtime of the UPS. If the worst comes to the worst and the regular shutdown sequence fails, it can happen that these are the first to be shut down. In any case, you can be sure that with a 40% charge everything should now work again as planned - it was originally planned and calculated for a remaining charge of 50%.

The finale: The core servers

These devices have not been considered further so far - they would currently run until the UPS performs its own shutdown and the emergency power fails. The consequences of this action would vary greatly depending on the server, from data loss to software and operating system corruption. In this case, there are beneath the standard Job with timing different ideas to preparing for this (they shall run until the last seconds):

1. About Battery weak/depleted/low (the exact term depends on the UPS)

This is a status issued by the UPS indicating that the batteries are about to run out. It is difficult to predict when a UPS will actually stop operating after this status has been issued; Because of its nature, a CS141 should only use this for information and logging or some quick action.

2. Via the custom threshold Alarm battery charge less than xx %

Die Warnung wurde bereits verwendet um sicherzustellen, dass alle Geräte sich im richtigen Betriebszustand befinden, kann man den Alarmzustand hier aktivieren, um basierend auf der Ladung in Prozent den eigenen Shutdown zu planen.

Beide Möglichkeiten führen zum Ziel, sind jedoch sehr unterschiedlich:

Option 1: is not recommended, since a UPS is very unreliable in the last few minutes, since it decides for itself when the point is reached, since it will switch off. However, if you know your server and how the react to a sudden death issue, you may give it a try.

Option 2 is plannable because the UPS Battery charge state is a fix system status.

In our example, we decide to use the custom thresholds and first take the Battery charge less than 15% alarm - mathematically, this would mean that the computers in this constellation would continue to run for about 30 minutes:

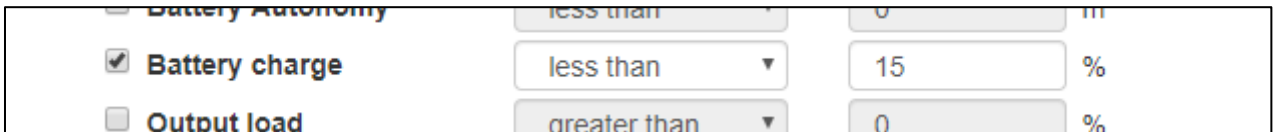

Now you have to think about the following.

1. How many minutes do the servers take to shut down?
2. How much time should be available as a buffer?
3. Do certain scripts have to be run before the shutdown can be initiated?
4. If scripts need to run, how long do they take?

Such a list can be very long and may have to be created individually for each device.

Ideally, we start from this consideration:

- Each server takes 3-4 minutes to shut down
- One server needs a "kill script" that takes 6 minutes to run.
- 5 minutes reservation for unexpected things should be included.

From this it follows:

1. The kill script and its server need 10 minutes to shut down + 5 minutes reserve = 15 minutes before the end, the shutdown must be started at the latest
2. The other servers should be shut down 10 minutes before the end.

So you do a rough calculation: 15% = 30 minutes, 7% = 15 minutes so the last shutdown sequences start somewhere at 12%.

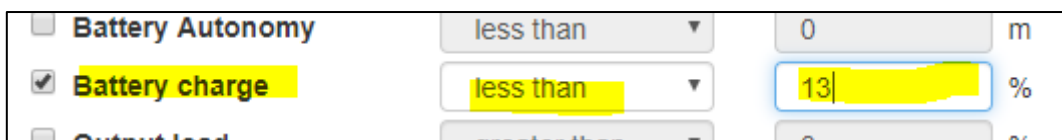

So as soon as the 13% is left, the alarm is active. The alarm area can now be found in the UPS event menu:

Job Type	When	Parameter
Log	Once, immediately	{"text": "Information: Battery charge in Percent Threshold Alarm On"}

Command 1: The kill script

Add Job to Event Battery charge in Percent Threshold Alarm On

Job: RCCMD Execute

Parameter

Host: Broadcast

Port: 192.168.2.10

Port: 6003

Command: startmykillerskript.bat

Timing

Immediately, once

After 180 seconds

After seconds, repeat all seconds

After seconds on Battery

At seconds remaining time

Save Cancel

With this command, the kill script is started directly on a target computer, just copy it into the RCCMD installation directory:

In this case, the RCCMD client checks whether the file exists and starts it with the local administrator rights that are in this directory.

The operating system starts the batch file accordingly as a background process - you will normally not notice anything in the frontend.

To ensure that no second command interrupts the script and shuts down the computer, this script should ideally run a shutdown script itself as its last action.

Accordingly, the last command must of course not be a broadcast, but must be passed to the last 4 computers.

Command 2: Die last shutdowns

Add Job to Event Battery charge in Percent Threshold Alarm On

Job: RCCMD Shutdown

Parameter

Host: Broadcast

Port: 192.168.2.11,192.168.2.12,192.168.2.13,...

Port: 6003

Timing

Immediately, once

After 180 seconds

After seconds, repeat all seconds

After seconds on Battery

At seconds remaining time

Save Cancel

This shutdown is aimed at the last 4 servers that are still running:

It is important that the Battery charge in Percent Threshold Alarm is on.

One of the 5 servers comes with its own shutdown and takes about 10 minutes, in this case the others have been instructed to shut down with a delay of 3 minutes (180) seconds via a collective job.

Mathematically, all servers shut down shortly before the end of the UPS autonomy time.

The event handling is a very powerful tool to carry out complex dependencies and autonomous event chains:

In addition to structured shut down scenarios, a CS141 can fulfil many other tasks depending on the individual hardware configuration level

- trigger alarm contacts and switches
- Inform superior and subordinate systems
- Monitor alarm wires and start or shut down servers as needed
- Switch and manage alarm wires
- Send emails
- Send SMS messages to responsible persons
- Include environmental sensors in the consideration

... and many more.

With complex event chains, it is very important that you think carefully about what you actually want to achieve and create a structured schedule before you start configuring the jobs accordingly.

Sensors and devices

For this configuration step, navigate to the following menu items:



Depending on used model, the CS141 offers to connect external sensors and devices sensors. These CS141 models support the connection of sensors:

- CS141 SC
- CS141 L
- CS141 R2
- CS141 Mini

SM_T_H_COM Standalone Sensor

This example shows how to configure the SMT_H_COM standalone sensor, a combined temperature and relative humidity sensor available for CS141.

The supplied standard length of the cable to connect the sensor to CS141 is 1.8 meters. If required, cable length up to 30m can be used.

Wiring the external sensor

Connect CS141 COM 2 to SM_T_H_COM. CS141 does not require to reboot.

Basic Setup Configuration

Under Devices / Setup, go to Configuration and change the setting at COM2 from none to Sensor.

After changing, define type of sensor connected to CS 141.

In this case, select SM_T_H_COM:

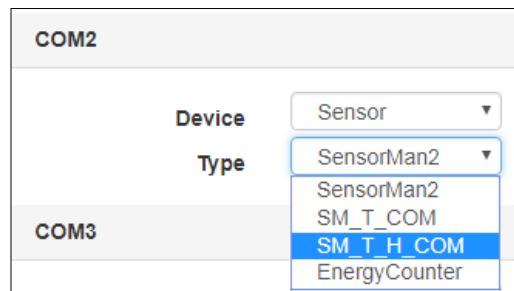
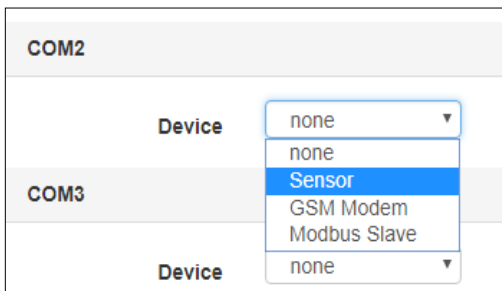

Press *Apply* to start the corresponding service. The status bar indicates the process.



While Sensor is restarting, the according menus will be prepared. Please wait until the Sensor mark is set to "OK" before entering the configuration dialog of the sensor.

Configuration of zhe SM T H COM combi sensor

Under the main tab Devices, open the sub menu Sensors and click on Setup. This will open the Sensor configuration dialog.

Name	Unit	Low PreAlarm	Low Alarm	High PreAlarm	High Alarm	Offset
Channel 1	°C ▼	10 <input type="checkbox"/>	5 <input type="checkbox"/>	80 <input type="checkbox"/>	90 <input type="checkbox"/>	0 <input type="checkbox"/>
water melon tank	% rel H	10 <input type="checkbox"/>	5 <input type="checkbox"/>	80 <input type="checkbox"/>	90 <input type="checkbox"/>	0 <input type="checkbox"/>

Name

Name

At Name, enter the name, a description or an installation place of the sensor. The Name will appear at the sensor monitoring screen.

Thresholds Low / High und Alarm functions

The SM_T_H_COM combined sensor provides two different sensor types. The temperature sensor operates between -25 ° C and +100 ° C. The humidity sensor measures humidity range 0% and 100%. After installing the sensor, the maximum sensor range will be shown without a range restriction or notification markers. In order to define an alarm behavior, the CS141 needs information about the critical values and if necessary, a configured measuring range.

Low PreAlarm	Low Alarm	High PreAlarm	High Alarm
7 <input type="checkbox"/>	5 <input type="checkbox"/>	60 <input type="checkbox"/>	80 <input checked="" type="checkbox"/>
0 <input type="checkbox"/>	0 <input type="checkbox"/>	249 <input type="checkbox"/>	135 <input type="checkbox"/>

Please note the following rules during configuration:

1. The pre-alarm must be lower than the critical alarm setting.
2. The relative humidity is a minimum of 0% and a maximum of 100%
3. The coldest temperature value is -25 ° C and the highest value + 100 ° C

Note:

As long as the checkboxes for the according alarm is not set, the respective alarm marker. Due to this fact it is possible to configure notification and alarm values and test the settings before activating.

Offset - Settings

Offset

Although the SM_T_H_COM is already a calibrated sensor, the operating environment may require different values. The correction values will be defined via offset settings:

These values will be added or subtracted from the value the sensor provide. This allow to harmonize the sensor values with callibrated external measurings and to adapt the sensor for special operating conditions.

Sensor-related system events

The CS141 provides defining system jobs via connected sensors. The available system events refer to the measured values of the connected sensors. The following events are available for SM_T_H_COM.

SM_T_H_COM Temperature High

The value at Threshold (high) defines the upper critical temperature limit. If this temperature is exceeded, a corresponding alarm behavior can be triggered.

SM_T_H_COM Temperature Low

The value Threshold (low) defines the lower critical temperature limit. If this temperature is undershot, a corresponding alarm behavior can be triggered.

SM_T_H_COM Temperature Normal

Defined by the values for the upper and lower temperature limits. If no limits are entered, any displayed temperature will be displayed as "normal".

SM_T_H_COM Humidity High

The value is defined by Threshold (high) for the relative humidity and determines the upper critical limit for humidity. If this value is exceeded, a corresponding alarm behavior can be triggered.

SM_T_H_COM Humidity Low

The value is defined via Threshold (low) for the relative humidity and determines the lower critical limit for humidity. If this value is undershot, a corresponding alarm behavior can be triggered.

SM_T_H_COM Humidity Normal

Defined by the values for the upper and lower relative humidity. If no limits are entered, any displayed humidity will be displayed as "normal".

SM_T_H_COM Connection Lost

If the connection between the CS141 and the SM_T_H_COM tears off, a corresponding alarm behavior can be triggered via this system event.

SM_T_H_COM Connection Restored

The counter event to Connection Lost: The connection has been restored; a corresponding alarm behavior can be triggered via this system event.

Event classification

At the sub menu Sensors, click on the menu Events:

All sensor events use the same event classification:

- Temperature / Humidity High
- Temperature / Humidity HighPreAlarm
- Temperature / Humidity normal
- Temperature / Humidity LowPreAlarm
- Temperature / Humidity Low

Click **>** to open the general job list. With **+**, the job configuration dialog will be triggered to add a new job to the current job list.

-	<input type="checkbox"/>	+		SM_T_H_COM Temperature High	1	1	0	0
				Job Typ	Wann	Parameter		
				Log	Einmal, sofort	{"text": "SM_T_H_COM Temperature High"}		

Note:
For detailed informationen about how to manage jobs, refer the following chapter: [Managing jobs](#)

Defining a counter job

Please note that depending on the configuration, some executable jobs require a so-called counter job, while other jobs merely do not need to be executed because the event is no longer pending. This job is configured by triggering it when the corresponding new event occurs - e.g. the contact is automatically closed when "Temperature: High" is reached and reopened as a counter event when "Temperature: Normal" is reached. Meanwhile, a mail notification is sent every 5 minutes as long as the Temperature High event is pending.

At this point, do not confuse a counter-event with a counter-job - one is an event that is pending, the other is a corresponding job that, triggered for any event chain - job and event are relative to each other.

Sensor monitor: Check configuration

For this screen, open the following menu:



→ Monitoring of sensors connected to CS141

Once completed all settings, the sensor data will be shown at Sensor Monitor:

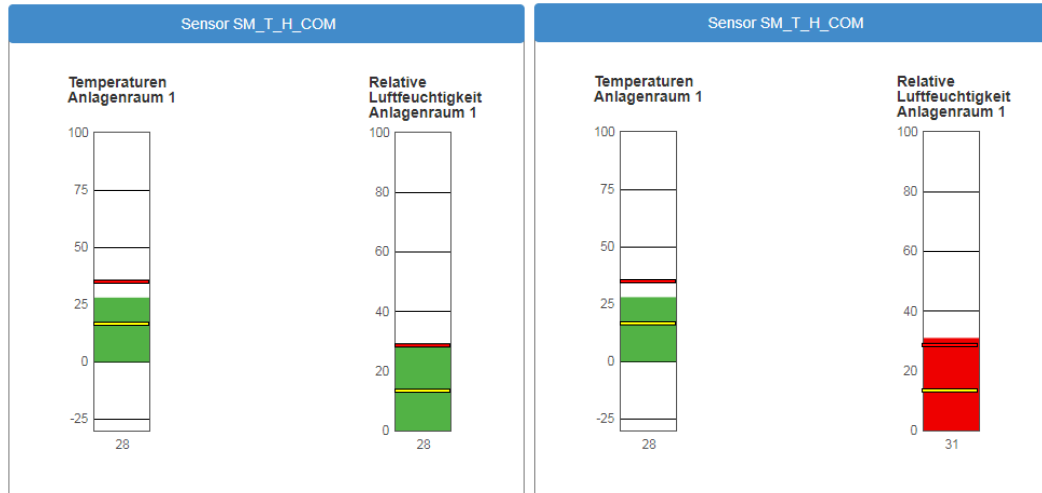

The yellow line represents the value of the Threshold (low). The upper line represents the Threshold (high). As soon as the value exceeds or falls below these lines, the color changes to red and a corresponding job can be triggered for the according sensor event. If you use pre-alarms and alarm settings, the Sensor monitor will show the according marker.

Tipp:

Sollten Sie mehrere Sensoren benötigen, bietet der CS141 über den Sensormanager die Möglichkeit, bis zu 8 Umweltkontrollsensoren zu betreiben.

Die genaue Konfiguration entnehmen Sie bitte der Installations- und Konfigurationsanleitung des SENSORMANAGERS, welche Sie unter www.generex.de im Downloadbereich erhalten können.

SENSORMANAGER

The SENSOR MANAGER is an optional accessory to extend the functionality of the CS141:

The GENEREX sensors / actuators can easily be connected to the SENSOR MANAGER, required RJ12 connection cables are included on delivery. The sensor can be configured via the web interface of the CS141 / BACSWEBMANAGER. Any third-party sensor or actuator that are conform with required specifications, can be used with the SENSORMANAGER.

SENSORMANAGER II application examples:*Monitoring of sensor data*

Temperature, humidity, electr.. Electricity, electr. Voltage, electr. performance and other analogue measurements.

Monitoring of contacts:

Door contacts, fire detectors, motion detectors, water detectors, glass breakage sensors and other potential-free signaling contacts.

Switching:

Switching of optical and acoustic actuators such as flashing lights, warning horns u. relay contacts

SENSORMANAGER II input signals:

Copyright of the European Union is effective (Copyright EU) (c) 2024 GENEREX Systems GmbH, Hamburg, Germany. All rights reserved
TEL +49(40)22692910 - EMAIL generex@generex.de - WEB www.generex.de (This and all other product datasheets are available for download.)

Up to 8 analog inputs (0-10VDC o. 0 / 4-20mA)
Up to 4 digital inputs (potential-free contacts)

SENSORMANAGER II output signals:

Up to 4 digital output signals (open collector / 12VDC max 30mA)

SENSORMANAGER II PIN assignment of the RJ12 connection sockets

INPUT 1:

Pin 1 9-24VDC, output according to input of supply voltage, default delivery: 12VDC power supply
Pin 2 Analog input channel 1 (0-10VDC o. 0/4-20mA)
Pin 3 Analog input channel 2 (0-10VDC o. 0/4-20mA)
Pin 4 Ground (GND)
Pin 5 Digital output (Open-Collector 9-24VDC/max. 30mA, Default on delivery: 12VDC)
Pin 6 Digital input (min./max. 9-24V via Pin 1)

INPUT 2:

Pin 1 9-24VDC, output according to input of supply voltage, default delivery: 12VDC power supply
Pin 2 Analog input channel 3 (0-10VDC o. 0/4-20mA)
Pin 3 Analog input channel 4 (0-10VDC o. 0/4-20mA)
Pin 4 Ground (GND)
Pin 5 Digital output (Open-Collector 9-24VDC/max. 30mA, Default on delivery: 12VDC)
Pin 6 Digital output (min./max. 9-24V via Pin 1)

INPUT 3:

Pin 1 9-24VDC, output according to input of supply voltage, default delivery: 12VDC power supply
Pin 2 Analog input channel 5 (0-10VDC o. 0/4-20mA)
Pin 3 Analog input channel 6 (0-10VDC o. 0/4-20mA)
Pin 4 Ground (GND)
Pin 5 Digital output (Open-Collector 9-24VDC/max. 30mA, default on delivery: 12VDC)
Pin 6 Digital input (min./max. 9-24V via Pin 1)

INPUT 4:

Pin 1 9-24VDC, output according to input of supply voltage, default delivery: 12VDC power supply
Pin 2 Analog input channel 7 (0-10VDC o. 0/4-20mA)
Pin 3 Analog input channel 8 (0-10VDC o. 0/4-20mA)
Pin 4 Masse (GND)
Pin 5 Digital output (Open-Collector 9-24VDC/max. 30mA, Default on delivery: 12VDC)
Pin 6 Digital input (min./max. 9-24V via Pin 1)

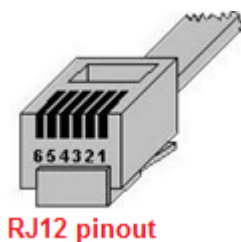

Pin number:	Funktion:
1	9-24VDC, output according to input of supply voltage, default delivery: 12VDC power supply
2	Analog input channel x (0-10VDC o. 0/4-20mA)
3	Analog input channel x (0-10VDC o. 0/4-20mA)
4	Ground (GND)
5	Digital output (Open-Collector 9-24VDC/max. 30mA, Default on delivery: 12VDC)
6	Digitalinput (min./max. 9-24V via Pin 1)

Note:

The voltage provided by pin 1, pin 5 and pin 6 is defined by the power supply unit used on the SENSOR MANAGER. The SENSOR MANAGER itself operates at an operating voltage of 9-24V. If a 12 V power supply is connected, 12 VDC will be offered on these pins accordingly. When connecting external devices, pay attention to the maximum permissible voltage that may be applied:

Overvoltage can damage or even destroy connected devices. In case of undervoltage, however, connected devices may deliver wrong results.

On delivery the SENSOR MANAGER comes with a standard power supply providing 12 VDC.

Analog inputs:

Each of the 4 SENSORMANAGER_II physical RJ-12 connectors provide 2 analog inputs on pin 2 and pin 3.

Administrators wishing to connect a third-party device, must set the signal (0-10VDC o. 0 / 4-20mA) of the third-party device to PIN 2 or pin 3 and pin 4 (ground / GRD).

Digital inputs:

Each of the 4 physical RJ-12 connections of the SENSORMANAGER_II provides a digital input on pin 6.

For Administrators who wish to connect a third-party device:

The high signal (12VDC) from pin 1 must be routed to pin 6 via the signaling contact of the third-party device.

Digital outputs:

Each of the SENSORMANAGER's 4 physical RJ-12 ports provides a digital output on pin 5.

Administrators who wish to connect a third-party device:

The device must be connected to pin 5 (open collector output: + 12VDC / max.30mA) and pin 4 (Ground / GND) are connected.

Note:**How to use third-party sensors**

Due to the fact third-party devices do not have the standardized RJ12 port, our Connection Terminal SM_CON is an easy-to use possibility to connect these devices to the CS141. By using the SM_CON it is possible to adapt open line ends to the Rj12 connector directly - No custom plug

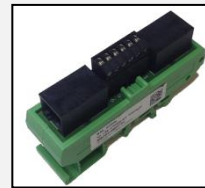
Connecting sensors / actuators to the SENSORMANAGER_II

The sensors / actuators for the SENSORMANAGER II can be connected directly to the SENSORMANAGER II RJ12 sockets- ensure to use the original RJ12 cables supplied with the according sensor.

The SENSORMANAGER II provides to connect several sensors / actuators to one physical port. The system design provides following wiring options:

1. A maximum of two analog sensors per port
2. A maximum of one more digital sensor per port
3. A maximum of one digital actuator per port

The sensor manager supports a total installation of 8 analog and 4 digital sensors as well as up to 4 digital actuators.

Sensor connection scenarios: SENSORMANAGER_II.

The SENSORMANAGER II provides various options to connect sensors.

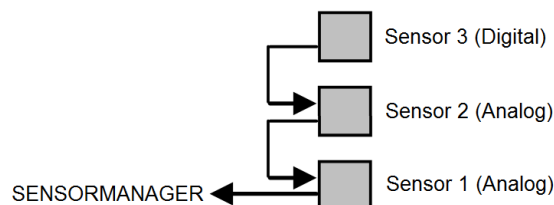
The Daisy Chain: Connection

The daisy chain is a sequential arrangement of sensors and actuators. The signal is transmitted from the sensor manager through the first sensor to the second sensor. In this installation example, a digital third sensor is attached to the second sensor. Please note that no further digital sensor can be attached to the sensor 3.

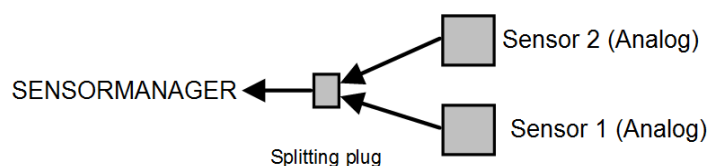
The Splitting Plug SPSMRJ connection

If sensors needs be installed in different areas, the signal distribution can be splitted into two wirings. The optional splitting plug will splitt the signal accordingly. Please note that the sensor manager can only serve two analog sensors per port.

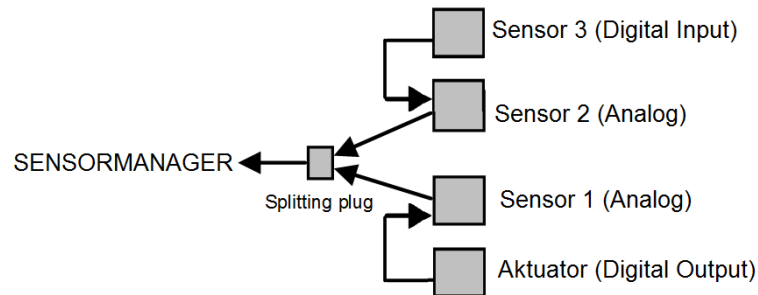
Combined connections: Daisy Chain and Splitting Plug SPSMRJ

This installation constellation extends the existing installation by an actuator and a digital sensor: The port on the sensor manager is maxed out utilizing a total of 4 devices:
Please note the system design:

This installation design provides the maximum of two analog sensors and one digital sensor as well as one digital output per sensor manager port.

SENSORMANAGER II: Available sensors

These sensors are currently available for SENSORMANAGER_II:

GENEREX-Analog-Sensors:

SM_T (Temperature sensor -> 1 analog channel required)
SM_T_H (Combined sensor: Temperature and humidity -> 2 analog channels required)
SM_VMC (True RMS AC voltage sensor -> 1 analog channel required)
SM_CSxxxA (AC- current sensor -> 1 analog channel required)

GENEREX-Digital-Input-Sensors

SM_HYG2 (water and humidity sensor -> 1 digital input required)
SM_Glas (Glas breach detector -> 1 digital input required)
SM_MD (motion detector -> 1 digital input required)
SM_SD (Smoke - und fire dector -> 1 digital input required)
SM_DC (door contact alarm detector -> 1 digital input required)
SM_H2 (Hydrogen Sensor -> 2 digital inputs required)

Digital GENEREX-Actuators:

SM_IO (Ralais-Box -> 1 digital output required)
SM_BUZ (accustical alarm buzzer -> 1 digital output required)
SM_Flash (flash light -> 1 digital output required)

SENSORMANAGER II – Installation and configuration

Before you start ...

The configuration must be saved to the PIC processor of the SENSOR MANAGER. This will be done by the CS141 automatically if pressing save buttons. If a configured SENSOR MANAGER needs to be replaced, the configuration stored in the CS141 must be written to the new PIC processor by applying again. A spare parted SENSORMANAGER will not work without writing the new configuration.

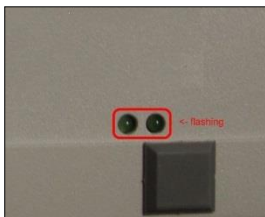
SENSORMANAGER II: Connecting to CS141

Use the supplied cable to connect the COM1 of the SENSOR MANAGER II to the COM 2 of the CS141. Log into the CS141 and go to general COM port settings. Configure the comport for sensormanager usage.

Then connect the power supply to the SENSORMANAGER:

Two LED's are installed on the underside of the SENSOR MANAGER: one should now light continuously and signal the operational readiness. The second LED flashes only when the CS141 makes a request to the SENSORMANAGER.

After the SENSORMANAGER is ready for configuration, open sensor manager configuration menu at CS141 and start configuring your sensors and devices.

Note:

The CS141 will only make a request to the SENSORMANAGER if it is configured accordingly. The LED on the sensor manager will only flash when a request has been received or is answered by the SENSORMANAGER.

Please note that the sensor manager is a stand-alone device with its own power supply. In case of main power supply is not available will cause disabling the connected sensors and actuators. The CS141 will notice this fact and can be configured to send custom alarm messages for sensor lost issues.

When using a SENSORMANAGER, ensure both, CS141 and SENSORMANAGER are secured by independent power supply (UPS) for full operationality in case of main power issues.

Sensor matrix

For this configuration step, proceed to the following menus

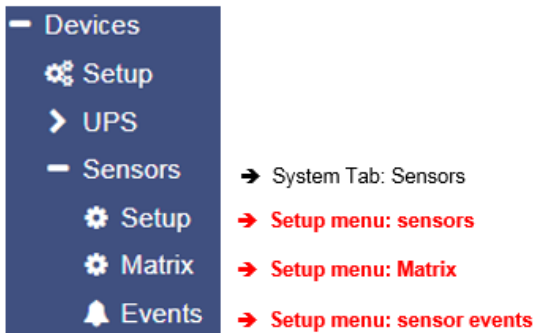

A special feature of the sensor manager is the possibility to link logically all available sensors and contacts via a matrix. Because the matrix does not tell you which sensors and digital inputs you want to use for linking to each other, there are numerous ways to map your operating scenario - as an example, a pressure sensor monitoring a pipe can be used with a temperature sensor on a corresponding pump in the first instance. With a second instance, different sets of sensor markers can be combined to trigger a unique alarm behavior.

How does the sensor matrix work?

As already described, the matrix is a link of individual instances that build on each other

1. Sensors and Inputs -> Individual single configuration and event management
2. Matrix marker -> Links logically individual sensors and digital inputs to a collective marker
3. Output switcher -> Links logically single alarm marker to switch an output

Each of these three instances has its own events, which can be assigned with jobs via the event control inside the sensor menu.:

Adding analog sensors

At system tab Sensors, open Setup to enter the sensor configuration dialog:

Sensor Inputs	Name	Sensortype	Unit	Low PreAlarm	Low Alarm	High PreAlarm	High Alarm	Sensor Range	Offset
1	Temperature	SM_T_H	°C	10	4	70	90	-5 - 100	
	Humidity	SM_T_H	% rel H	17	15	28	30	0 - 100	

Name

Enter a name or a description that will be shown at the alarm matrix as well as the sensor monitor.

Sensortype

Determine the type of sensor. To do this, select one of the predefined sensor types from the list. For third-party sensors, please consult the appropriate user manual to enable connection. Please note that some sensors are so-called combined sensors - two sensors in one housing. These require both channels and no further sensors can be connected.

Unit

With the choice of the sensor a suggestion for the indicated unit name appears. You can customize the name to your liking, but the unit that you see as a suggestion will not change itself.

Pre-alarm / alarm

Passen Sie an dieser Stelle die entsprechende Alarmstufe an. Dabei gilt folgendes Grundprinzip:

Adjust the appropriate alarm level. The following basic principle applies:

With increasing values on a measurement scale, the pre-alarm is BEFORE the actual alarm - at a temperature, e.g. the pre-alarm (pre-alarm) at 70 °C - the actual alarm is 90 °C. As the values decrease, the concept revolves: the pre-alarm must be higher than the actual alarm - in relative humidity, this means the pre-alarm is at 17% humidity during the actual alarm, which would be triggered at 15% relative humidity.

Note:
Please keep in mind, with decreasing temperatures the pre-alarm may be set with +3°C, but the actual alarm is at -5°C. From 0°C down, the numbers will start to increase with a negativ sign.

Sensor range

Many sensors have a predefined measuring range - in other cases it makes no sense to create a measuring range outside certain operating values. With this value range, it is possible to adjust the measuring range to a custom sensor as well as to specific operating environments.

Offset

Although all sensors are calibrated on delivery by GENEREX, operating conditions may use different reference values. The values may differ as a result from changing atmospheric pressure, ambient temperatures, solar radiation, etc. Use the offset values to adjust the values to fit to a local reference measuring. Simply enter the corresponding deviation:

If e.g. If your reference reading deviates downward at a temperature of 2 ° C, enter -2 as offset value.

Sensor event vs matrix event

Configured sensor alarms can be used to configure according event:

For each analog sensor, you will find 2 according events:

- Alarm Analog Input High -> Alarm: critical value reached or exceeded high alarm settings
- Alarm Analog Input High off -> Alarm: Critical value fell below high alarm settings
- Pre-Alarm Analog Input High -> Pre-Alarm: Questionable value reached or exceeded high pre-alarm settings
- Pre-Alarm Analog Input High off -> Pre-Alarm: Questionable value fell below high pre-alarm settings
-
- Normal state – no alarm -> No alarm configurable
-
- Pre-Alarm Analog Input Low off -> Pre-Alarm: Questionable value fell below low pre-alarm settings*
- Pre-Alarm Analog Input Low -> Pre-Alarm: Questionable value reached or exceeded low pre-alarm settings*
- Alarm Analog Input Low off -> Alarm: Critical value fell below low alarm settings*
- Alarm Analog Input Low -> Alarm: critical value reached or exceeded high alarm settings *

*) Please note the paradox that the value can also increase with negative values (eg at temperatures in the minus range).

For each of these events, you can configure a corresponding job to setup a specific alarm behavior. Using the alarm matrix, you can summarize the corresponding events and stitch them an event marker with coming with it's own conditions.

Open the menu Matrix to find all events as checkbox list:

Sensor Inputs	Name	Sensorty																		
1	Temperature Area 51	SM_T_H																		
	Humidity in % Area 51	SM_T_H																		
			1	2	3	4	1	2	3	4	1	2	3	4	1	2	3	4		
			<input checked="" type="checkbox"/>	<input checked="" type="checkbox"/>	<input type="checkbox"/>	<input type="checkbox"/>	<input type="checkbox"/>	<input type="checkbox"/>	<input type="checkbox"/>	<input type="checkbox"/>	<input type="checkbox"/>	<input type="checkbox"/>	<input type="checkbox"/>	<input type="checkbox"/>	<input type="checkbox"/>	<input type="checkbox"/>	<input type="checkbox"/>	<input type="checkbox"/>		
			Sensor Input 1				7	8	5	6	7	8	5	6	7	8	5	6	7	8
			Temperature Area 51				<input type="checkbox"/>	<input type="checkbox"/>	<input type="checkbox"/>	<input type="checkbox"/>	<input type="checkbox"/>	<input type="checkbox"/>	<input type="checkbox"/>	<input type="checkbox"/>	<input type="checkbox"/>	<input type="checkbox"/>	<input type="checkbox"/>	<input type="checkbox"/>	<input type="checkbox"/>	<input type="checkbox"/>

At sensor configuration, you can enter a name for each channel. After entering a name press apply and change to the menu „Matrix“: The recently entered name will be displayed automatically as soon as you move the mouse over the according channel checkbox.

Setting up the logical connection

Using the logic link, the condition can be defined to set the marker to a logical On:

And Both conditions must be met
 Or At least one of the configured conditions are met.

Inverted mode

As a standard, the marker is pre-configured to switch to ON as long as the conditions for ON are met. The inverted turns this switching behavior from OFF to ON: The marker is always at High (ON) position and will switch to Low (Off).

Digital inputs

In addition to analog inputs, the SENSORMANAGER can manage up to 4 digital inputs. The inputs

Diese Eingänge werden entsprechend der Konfiguration auf Aktiv geschaltet und können im Alarmverhalten als NC (Normally Closed) oder NO (Normally Open) – Kontakt definiert werden.

Input	Name	NC Contact	Active
1	<input type="text" value="hull brake aquarium 2"/>	<input type="checkbox"/>	<input checked="" type="checkbox"/>
2	<input type="text" value="water level below 80%"/>	<input type="checkbox"/>	<input checked="" type="checkbox"/>

Linking digital inputs

The marker only looks whether the result of the digital input is "High (On)" or "Low (Off)" - The type of contact is unimportant for the marker. Like the analog inputs, name of the digital input will be shown by mouse over action. The linking of the digital inputs follows the same principle as with the sensors.

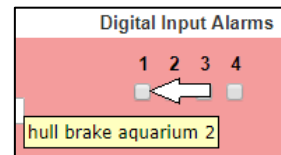

Linking digital inputs and analog sensors

Simply select the appropriate digital inputs with the analog inputs. Press Apply to save the setting and restart the services for the sensors.

Switching an output

Outputs will be switched in case of conditions met via the defined alarm markers:

SensorMan2 Digital Outputs			
Port	Name	Logic	Marker
1	Output 1	And ▼	1 <input checked="" type="checkbox"/> 2 <input checked="" type="checkbox"/> 3 <input type="checkbox"/>
2	Output 2	Or ▼	1 <input type="checkbox"/> 2 <input type="checkbox"/> 3 <input type="checkbox"/>
3	Output 3	Or ▼	1 <input type="checkbox"/> 2 <input type="checkbox"/> 3 <input type="checkbox"/>
4	Output 4	Or ▼	1 <input type="checkbox"/> 2 <input type="checkbox"/> 3 <input type="checkbox"/>

In contrast to the markers, however, no pre-alarms are used - if the marker is set to high, the output will be switched depending on its switching logic. The CS141 matrix provides combining up to 8 markers individually and assign them with an AND / OR combination. The output will be switched:

1. As soon as only one of the configured marker are set to high. („OR“)
2. As soon as all configured marker are in high state („AND“)

Fallback of the output to normal state

the output is only switched as long as the condition has been fulfilled exactly hereby the corresponding logical link will decide which condition leads to the drop of the output:

In a restrictive AND operation, only one marker to off will force the output to off.

With an OR operation, the output remains at ON state until each marker is turned off.

Keep in mind that the markers conditions for an on/off state will not be checked by output switching control – This control only checks logically the markers state and act according to it.

Tutorial: Example scenario: aquarium

In this simple example the cross reference between a cracked disc and a leaking aquarium will be described. It shall show you how markers, inputs and outputs will be linked and work together. The total scope of scenarios can reach very high complexity and fitted even to very custom problems....

Huge aquariums with large glass panels are dependent on ensuring the structural integrity. If a glass panel is damaged or cracked, a corresponding alarm must be issued automatically. For this purpose, the sensor manager offers a digital input:

Input	Name	NC Contact	Active
1	hull breach alert aquarium 2	<input type="checkbox"/>	<input checked="" type="checkbox"/>

The method this crack sensor uses to detect a cracked glass is a secondary question as the SENSOR MANAGER also supports the connection of third-party sensors. If necessary, connect an additional relay box to each sensor manager input: With the SM_IO box, managing all 4 inputs and outputs is made intuitive.

In this scenario, a glass crack sensor would close a switch and thus report a problem to digital input 1.

The second essential value is the water level of our aquarium, which requires intervention drops below a certain amount of water. In this case, a level sensor is used, which closes a digital contact at a filling level of 80%:

2	water level below 80%	<input type="checkbox"/>	<input checked="" type="checkbox"/>
---	-----------------------	--------------------------	-------------------------------------

This input clearly indicates that the water level has dropped, but not why it happened - normally this will be caused by natural evaporation.

The cross reference:

Using the matrix, you can now handle both events in conjunction to each other:

In this case, marker 1 would be set active if both inputs are closed at the same time: The idea is that a glass crack alarm is present AND the level has dropped below 80% - in this case someone should be informed at once.

In the Events menu, fsearch for Alarm Marker 1:

In diesem Beispiel soll eine SMS geschrieben werden, sobald beide Bedingungen erfüllt sind:

In this example, an SMS should be sent as soon as both conditions are met:

At the moment the marker is activated, the CS141 will issue an emergency SMS if a GSM modem or alternatively an IP modem is available. Thus, both individual input events have been directly connected, other jobs are possible that will be repeated as long as this marker status is present.

Add Job to Event Alarm Marker 1

Job:

Parameter

Text:

Phone:

The marker status will be terminated with two basic conditions:

1. The water level has been corrected
2. The glass damage has been fixed

Since these two conditions are coupled by an AND link, this marker is triggered only when both conditions are met.

Using several markers

This marker can handle two basic problems:

A dropping water level below 80% and some kind of cracking glass. And yes, if this happens simultaneously, it is possible that water leaks. Due to the fact, 20% water inside an observation room can be very many water, a third sensor may be useful:



This sensor will find water or increased humidity levels at visitors observation room - something that can only be caused by a cracked aquarium windows (or something visitor- caused).

With the matrix settings, a second sensor can be configured:

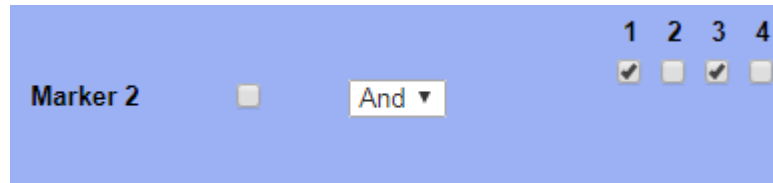

This marker defines that there is a glass breach alert present and water is found at visitors observation room., dass ein Glasbruchproblem vorliegt und im Besucherraum zudem Wasser auftritt.

The Or connection

Okay, from now on the emergency conditions are set:

1. Glass breach and water level drops below 80%
2. Glass breach and water found at visitors observation room

Es However, it may now be the case that the water level drops and / or water is reported in the visitors' area without an obvious glass breakage. This may happen and someone need to mainenance this issue, but it is not really critical. In some cases it could be wanted.

To show this scenario, a third marker can combine both conditions with an OR:

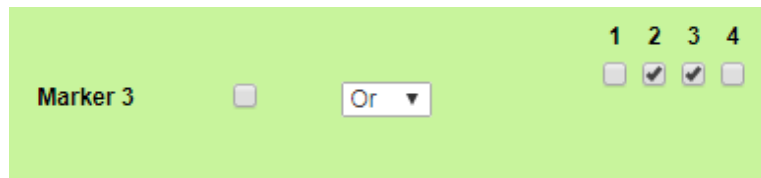

This basic marker can be used as a non-critical overview lookup:

1. Water level below 80%
2. Unusual Humidity or liquids found at visitors observation room

With the OR operation, these two conditions can occur independently of each other - in both cases, the marker is set to high – on the other hand, this marker will only fall back to off position if all standard maintenance work is done.

Switching outputs

In this example scenario, many trigger points are included. For the matrix, these issues are configured:

- Glass breach **and** dropping water level
- Glass breach **and** water/liquids at visitors observation room
- Dropping water level **or** water/liquids at visitors observation room

Die kritischen Probleme sind hierbei mit festen UND-Bedingungen verknüpft, da ein schnelles Handeln erforderlich ist. Die Eskalationsstufe ist, dass alle 3 Ereignisse aufeinandertreffen: Es gibt ein Glasbruchproblem, der Beobachtungsraum läuft voll Wasser und der Füllstand auf 80% gesunken ist.

The critical issues here are linked to fixed AND conditions because quick action is required. All three problems together means, visitors can be endangered: There is a glass break problem, the observation room will be filled by water and the water level has dropped below 80%. Perfect for automatic emergency procedures - all critical I markers can be summarized and linked to an

SensorMan2 Digital Outputs									
Port	Name	Logic	Marker						
1	Output 1	And ▾	<table border="1"> <tr> <th>1</th> <th>2</th> </tr> <tr> <td><input checked="" type="checkbox"/></td> <td><input checked="" type="checkbox"/></td> </tr> <tr> <td><input type="checkbox"/></td> <td><input type="checkbox"/></td> </tr> </table>	1	2	<input checked="" type="checkbox"/>	<input checked="" type="checkbox"/>	<input type="checkbox"/>	<input type="checkbox"/>
1	2								
<input checked="" type="checkbox"/>	<input checked="" type="checkbox"/>								
<input type="checkbox"/>	<input type="checkbox"/>								
2	Output 2	And ▾							

output:

As long as marker 1 and marker 2 are set to ON (high), output 1 will be triggered: :

Ausgänge			
Name	Status	Anschalten	
1 Output 1	●	Switch Off	
2 Output 2	●	Switch On	
3 Output 3	●	Switch On	
4 Output 4	●	Switch On	

UPS: ● OK

Sensor: ● Output 1 On

This output can inform ordinate and subordinate monitoring systems via alarm contacts, switch of switch off sockets near the floor, etc. Via the event "Output 1 On", any additional job chains can be created inside for advanced automatic emergency measures.

Fallback to normal state

The output will be switched off in case of one of these markers fall back to normal state.

Note

As with the configuration of the markers, you can create an And / Or dependency between up to 8 different markers. As an example, this function is useful if a machine may only be started if preconditions like pressure, temperature, etc. met specific operating values. By using the matrix, the output that unlocks the start button will not be released until all conditions have been met..

Combination of sensors coming with the sensor matrix

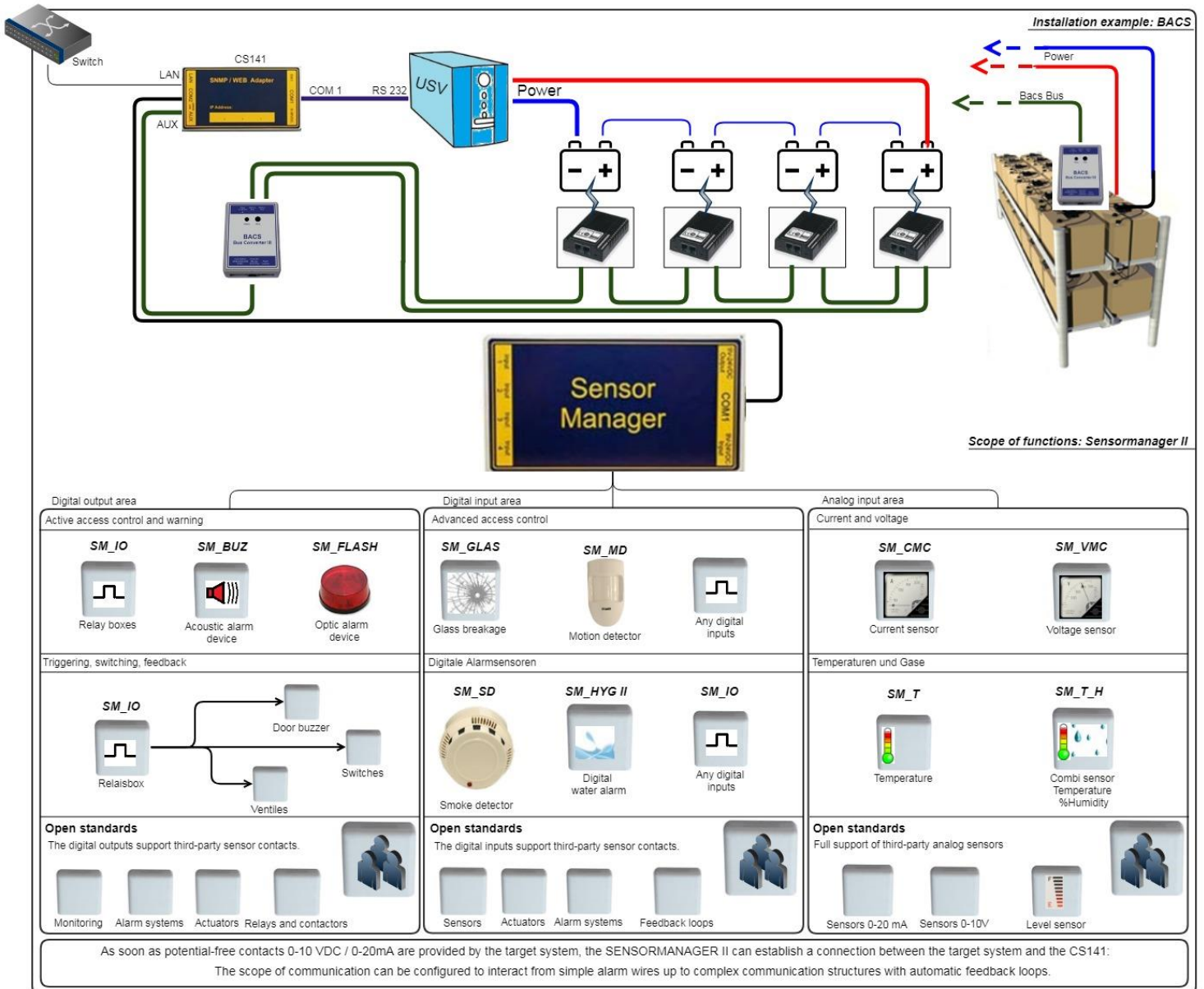

Buzzer

The CS141_BUZ is an acoustic alarm to be used with the CS141 SNMP adapter (CS141 SC or CS141 L). The CS141_BUZ is based on a piezo element using an internal power supply. Due to this fact, no separate power supply is required. The volume is about 85 db. The CS121_BUZ provides an RJ12 to be directly connected to CS141. Furthermore, an RJ12 socket for the output of PINs 1, 2, 3 to use external devices.

In addition, the acoustic signal of the buzzer can be remotely reset by closing a potential-free contact via the two-poled contact terminal block. Furthermore, a LED indicates a manually switched off alarm. This LED will stay blinking until it will be triggered by CS141 to normal state.

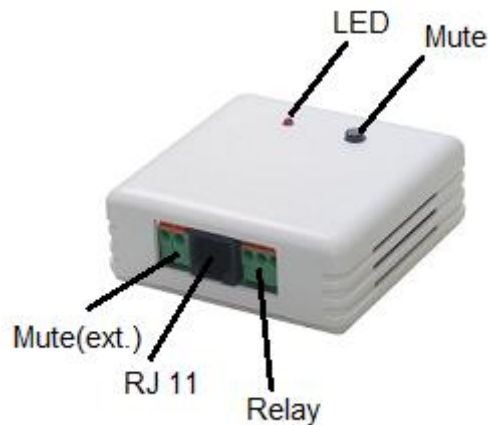

Technical data:

voltage usage:	12 – 15 VDC
power usage:	ca. 30mA
Volume:	ca. 85 dB
Connection type:	wired, RJ12, 6_5, 5_m
Dimensions:	70 x 70 x 40 mm

Connect to CS141:

Use enclosed cable to connect the buzzer CS141_BUZ to AUX Port of CS141.

Configure the buzzer:

Step: 1

COM3

Device

Under Devices/Setup, select Buzzer at COM and press Apply.

Step 2

Under Devices you find the buzzer alarm menu:

Apply transfers the current setting to the system configuration. Selected functions will be displayed at the BUZZER MONITOR. Furthermore, in the upper status bar the buzzer will be shown as operational.

Step 3:

Select an event the buzzer shall toggle – as an example buzzer alarm if recognizes a power fail

Press + to open job configuration dialog:

Under Job select Buzzer:

Relays on

Additionally, the buzzer provides a relay for external connections to be switched.

Buzzer on

In case of a power fail the buzzer will be triggered. As soon as main power returned back, the event "Power restored" needs a job to switch off buzzer.

Events according to a buzzer

Search for the buzzer event menu:

>	+	Event	Jobs	Log	Email	Email Trap	RCCMD Shutdown	RCCMD Message	RCCMD Execute	UPS Shut
		contains...								
>	+	Relais On	1	1	0	0	0	0	0	0
>	+	Relais Off	1	1	0	0	0	0	0	0
>	+	Buzzer On	1	1	0	0	0	0	0	0
>	+	Buzzer Off	1	1	0	0	0	0	0	0

At BUZZER ON click + to start job the configuration dialog

Choose the job to be executed, because the buzzer was triggered.

Depending on your setting, a corresponding action will be triggered in addition to the triggered buzzer and simultaneously noted in the event log.

Add Job to Event Relais On

Job: RCCMD Message

Parameter

Text:

IP: Broadcast

Port:

Timing

Immediately, once

After seconds

After seconds, repeat all seconds

After seconds on Battery

At seconds remaining time

Save Cancel

Note:

You can define structured job chains by different devices connected to the CS141: Therefore, it is possible to select the BUZZER from inside the AUX menu and trigger it and use this system state to trigger the next event accordingly. In that case, the AUX event handling will trigger the buzzer and then the next event.

Events related to other devices

Events for this device can be performed by any device connected to the CS141.

As example, an SMS is triggered by an alarm transmitter - a buzzer - because the alarm relay has jumped to ON:

>	+	Ereignis	Jobs	Log	E-Mail	Email Trap	RCCMD Shutdown	RCCMD Nachricht	RCCMD Execute	UPS Shutdown	Buzzer	RCCMD Trap	Send WOL	Send SMS
		contains...												
>	+	Relais On	1	1	0	0	0	0	0	0	0	0	0	0
>	+	Relais Off	1	1	0	0	0	0	0	0	0	0	0	0
>	+	Buzzer On	1	1	0	0	0	0	0	0	0	0	0	0
>	+	Buzzer Off	1	1	0	0	0	0	0	0	0	0	0	0

At the event RELAIS ON, click + to start the configuration dialog:

Under Job, select the job to be executed because the buzzer's relay has been triggered.

Depending on your setting, a corresponding action will be triggered in addition to the triggered buzzer.

Note:

If installed, you can also select the BUZZER via the AUX menu and may it have triggered accordingly. In that case, the AUX event will trigger the buzzer. The fact the buzzer is triggered will be able to trigger the next event. This behavior allows you to define as many individual events as well as event chains. You can even configure time delays ...

GSM-Modem

A GSM modem provides the ability to notify responsible persons via SMS as an additional security measure. This is useful to help staff reducing response time.



GSM-T61

3GT61

Technical data:

GSM-T61

Power supply:	12 – 15 VDC
Power consumption:	ca. 30mA
Dimensions:	70 x 70 x 40 mm

3GT61

Power supply:	12 V
Power consumption:	ca. 50mA
Dimensions:	70 x 70 x 40mm

Setting up the SIM card

There is no option to store access data for the SIM card inside the GSM modem or at the CS141. The SIM card must be configured accordingly by a network-compatible device to ensure no dial-in data ("without PIN") will be required for operation: The corresponding configuration guide for your SIM card can be obtained from your mobile service provider as well as from the operating instructions of the device selected for the configuration.

Insert / remove the SIM card

Once the SIM card has been configured appropriately to be used with the GSM modem, it can be inserted into the device. Please note that you insert the SIM card with the contacts upwards with slight pressure until it locks in place by a spring mechanism. To remove, press the SIM card to unlock the mechanism:

The card pops out and can be removed.

How the GSM modem works

SMS modems provide the ability to notify responsible contact persons or administrative personal independently to any other automatic notification procedures in a very direct way. Due to the fact the GSM modem is a standalone device, it will work even in worst case scenarios when the intranet of a company is not available.

If emergency situations occur, it will help to shorten reaction time chain essentially.

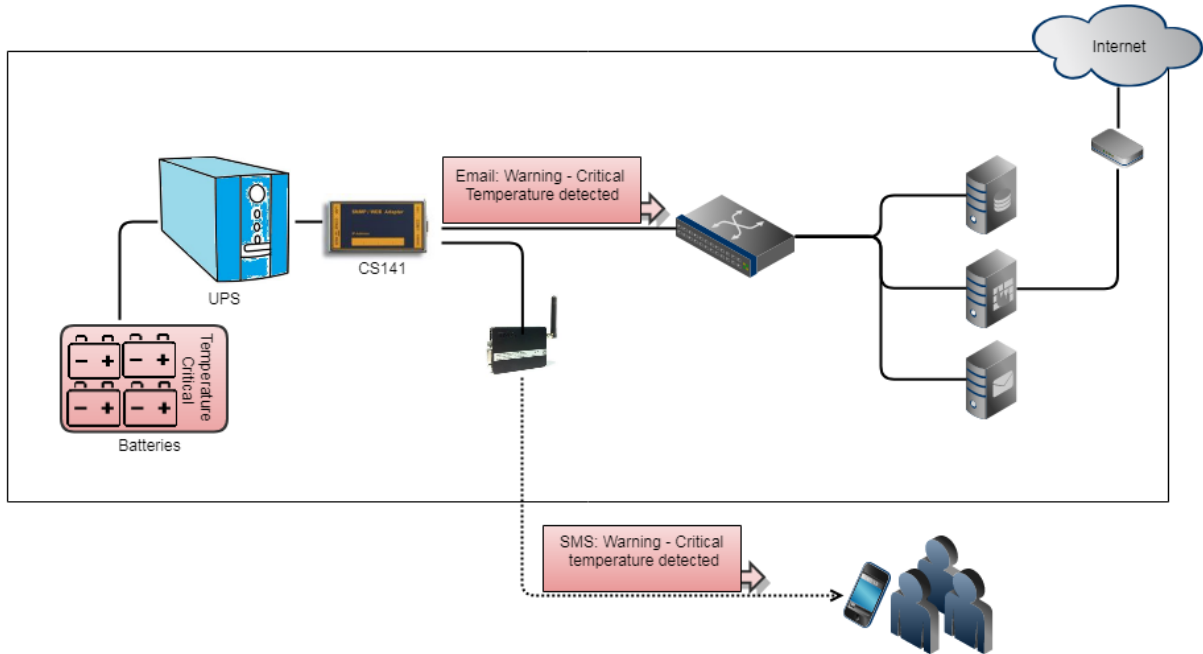

In cooperation with other auxiliary devices, the GSM modem can be configured for numerous events:

- Critical temperature measurements
- Door contacts / access control and unauthorized entry
- Parent and child system failures
- Emergency ventilation usage
- ...

Please note that a GSM modem is intended for sending short messages and is not designed to connect to the CS141 via the local mobile network. Currently the following options are supported:

- A GSM-Modem as serial standalone device
- IP/SMS-Gateway SMS communication

CS141: Setting up the GSM modem for serial usage

For this configuration step, navigate to the following menu



Connect the COM port of the modem to COM2 interface of the CS141 and connect the power adapter. After connecting, open the CS141 system tab Devices. At COM-Port 2, Select GSM Modem

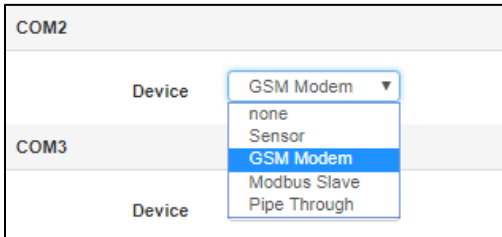

The GSM modem symbol should appear in the upper bar and show the quality of the signal accordingly:



In addition, the CS141 will display the system tab GSMModem:

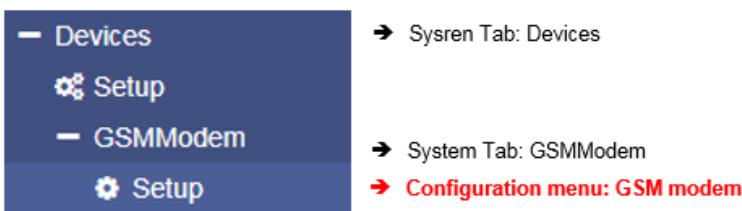

Serial COM port connection

To use a serial connected GSM modem, select com as operating mode.

If necessary, adjust the values for baud rate parity and stop bit. Please note:

default values in normally represent the optimal setting and do not need to be changed.

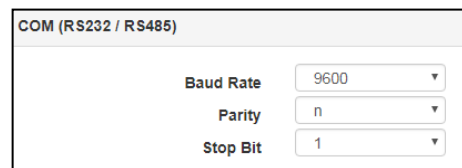

Job configuration using an SMS

Under UPS event handling, choose the event *Powerfail*.

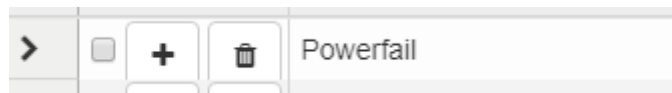

Press + to begin with the job configuration dialog

Choose the job Send SMS.
SMS text allows you to enter a small text message.

Under Phone, enter the mobile phone number of the SMS receiver.
Ensure there are no spacers at the phone number you entered.

Use Timing to configure how often an SMS should be sent.

Press Save to finish job configuration.

The example dialog screenshot job will be triggered in case of a power fail occurs and send an SMS. If several parties need to be informed, define a separate job for each mobile number.

When you need an sms if other devices are triggered

Any device that is listed with a system event can be used to trigger an sms job. In this example, a buzzer will be used to trigger an sms.

		Ereignis	Jobs	Log	E-Mail	Email Trap	RCCMD Shutdown	RCCMD Nachricht	RCCMD Execute	UPS Shutdown	Buzzer	RCCMD Trap	Send WOL	Send SMS
>	<input type="checkbox"/> +	contains...	<input type="checkbox"/>											
>	<input type="checkbox"/> + <input type="checkbox"/>	Relais On	1	1	0	0	0	0	0	0	0	0	0	0
>	<input type="checkbox"/> + <input type="checkbox"/>	Relais Off	1	1	0	0	0	0	0	0	0	0	0	0
>	<input type="checkbox"/> + <input type="checkbox"/>	Buzzer On	1	1	0	0	0	0	0	0	0	0	0	0
>	<input type="checkbox"/> + <input type="checkbox"/>	Buzzer Off	1	1	0	0	0	0	0	0	0	0	0	0

At the event RELAY ON, click +

As Job, choose SMS, enter the text message and a valid phone number.

As a consequence, the event chain will be shown as followed:

Because there is a power fail, the buzzer is on and the relay is on. Because the Relay is on, the SMS will be sent with a custom text and logged accordingly

Note:

These event chains are very capable: In theory, it is possible to set up very complex event chains, where a job triggers the next event, etc. – you can use inputs and outputs to communicate all over the IT without the need of a network: “High/Low” or “ON/OFF” can trigger many things and produce complex notification alerts.

But be careful when using long event chains: They may brake if a single device is not available or configured accordingly.

CON_AUX4 and CON_R_AUX4

There is more than one method to communicate with parent and child systems: The external devices CON_AUX4 and CON_R_AUX4 provide input as well as outputs to get information as well controlling third-party devices:

To start configuration, define COM3 as AUX port. Type will be used to toggle between CON_AUX4 and CON_R_AUX4.

Configuration

Once the AUX service has been started, the general operability is displayed accordingly in the upper bar. Please wait until the service is ready to use before accessing the configuration menu - it will appear automatically as a sub menu at Devices.

Depending on whether a CON_AUX4 or CON_R_AUX4 has been connected, the configuration screen will differ:

Port	Name	NC-normally closed
1	AUX Port 1	<input type="checkbox"/>
2	AUX Port 2	<input type="checkbox"/>
3	AUX Port 3	<input type="checkbox"/>
4	AUX Port 4	<input type="checkbox"/>

Figure 1: Configuration menu – CON_AUX4

Port	Name	Output	NC-normally closed	Switch on cs141 Powerup	Powerup Delay (seconds)
1	AUX Port 1	<input type="checkbox"/>	<input type="checkbox"/>	<input type="checkbox"/>	0
2	AUX Port 2	<input type="checkbox"/>	<input type="checkbox"/>	<input type="checkbox"/>	0
3	AUX Port 3	<input type="checkbox"/>	<input type="checkbox"/>	<input type="checkbox"/>	0
4	AUX Port 4	<input type="checkbox"/>	<input type="checkbox"/>	<input type="checkbox"/>	0

Figure 2: Configuration menu – CON_R_AUX4 Port

1: Port

Current port number

2 Name

Since the cable of the target device can be up to 60 meters, define a name or location. The field Name is freely editable.

3 Output

The ports can be configured as an output to switch potential-free contacts. This function is only available at CON_R_AUX4.

5 NC normally closed

Determine if the input / output normally contains an open or closed contact. Among other things, this function defines the alarm behavior

Switch on cs141 Powerup

The port is automatically switched on if the CS141 is starts or after reboot.

7 Power up delay

During CS141 boots, the port will be turned on after predefined seconds. This allows a time-delayed startup or switching through potential-free contacts during a restart.

8 Apply / Cancel

Apply will save the configuration and restart the service – a reboot is not necessary. Cancel will abort configuration dialog without saving data.

Define jobs to an AUX-Port

Under devices, navigate to AUX Event configuration menu:

Setup		AUX Event Configuration													
>	<input type="checkbox"/> +	Ereignis contains...	Jobs	Log	E-Mail	E-Mail Trap	RCCMD Shutdown	RCCMD Nachricht	RCCMD Execute	UPS Shutdown	AUX	RCCMD Trap	Send WOL	Send SMS	
>	<input type="checkbox"/> +	AUX Port 1 High	0	0	0	0	0	0	0	0	0	0	0	0	
>	<input type="checkbox"/> +	AUX Port 2 High	0	0	0	0	0	0	0	0	0	0	0	0	
>	<input type="checkbox"/> +	AUX Port 3 High	0	0	0	0	0	0	0	0	0	0	0	0	
>	<input type="checkbox"/> +	AUX Port 4 High	0	0	0	0	0	0	0	0	0	0	0	0	
>	<input type="checkbox"/> +	AUX Port 1 Low	0	0	0	0	0	0	0	0	0	0	0	0	
>	<input type="checkbox"/> +	AUX Port 2 Low	0	0	0	0	0	0	0	0	0	0	0	0	
>	<input type="checkbox"/> +	AUX Port 3 Low	0	0	0	0	0	0	0	0	0	0	0	0	
>	<input type="checkbox"/> +	AUX Port 4 Low	0	0	0	0	0	0	0	0	0	0	0	0	

Click **+** to start the configuration dialog.

Possible jobs and timing configuration is similar to UPS event configuration

Add Job to Event AUX Port 1 High

Job

Parameter

Text

Zeitpunkt

Sofort, einmalige Ausführung

Nach Sekunden

Nach Sekunden, wiederhole alle Sekunden

Nach Sekunden auf Batterie

Bei Sekunden Restlaufzeit

This example will trigger a job in case of AUX Port 1 is set to high. (on)

Trigger AUX Ports to high/low (on/off):

The AUX ports can be triggered as a job:

As an example, open Event Powerfail at UPS event handling. Select job AUX. Choose the port number that should change a state in case of a power fail occurs. Under Command, select the state the AUX port should be switched to.

Note:

The port state to be switched to is completely independent to the actual switching state. If the port is set to high/on and you switch the port to high, it will be switched accordingly again. Timing configuration is similar to other jobs

Switch an output

With CON_R_AUX 4, it is possible to switch a potential-free relay contact on activation:

Manually switched

AUX Port 1		AUX Port 2	
Port	1	Port	2
Usage	Input	Usage	Output
Inverted	Yes	Inverted	No
State	●	State	●
<input type="button" value="Switch On/Off"/>		<input type="button" value="Switch Off"/>	

➔ Manual switching on / off of a port

Each channel defined as output can be manually switched by pressing the Switch on button at AUX monitor.

AUX status monitor

For monitoring, CS141 provides an AUX Status Monitor. To open the AUX Status Monitor, select AUX Monitor from the top-level menu:

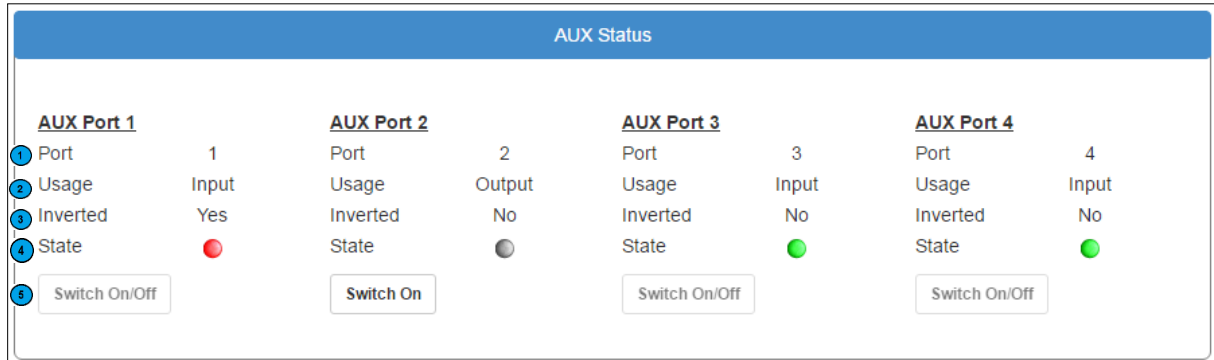

Figure: CON_R_AUX 4 AUX Monitor: Port 1 is inverted, port 2 is output and port 3/4 is default

1: Port

Port number shows the current port.

2: Usage

Usage shows whether the used port is configured as input or output.

3: Inverted

Inverted provides information about the behavior of how the connected device should be interpreted. There are two valid states:

Inverted: No

The connected contact must normally be closed.

Inverted: Yes

The contact is normally considered "open". This function can thus be used to invert the alarm behavior.

4: State

State displays the current switching state. Please note this state will change according to the LEDs at CON_AUX4 and CON_R_AUX4. Due to the fact web technology is used, there is a time delay based on refreshing time of the browser.

5: Switch on /off

If a port is defined as output, this button will toggle the current state of the output.

Scheduler

For this configuration step, navigate to the following menu:

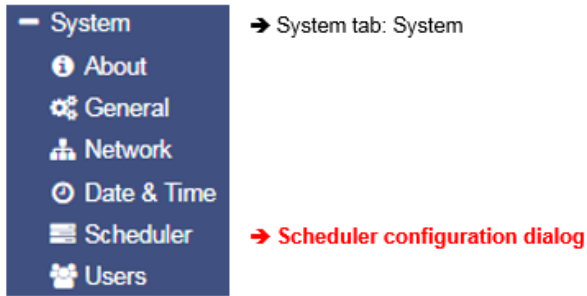

Regardless of all system events, the models of the CS141 series offer the possibility to run jobs at freely definable times.

These so-called scheduled jobs can be used, for example, to control subordinate systems, to restart computers, to perform battery tests, etc.

Configuration menu for scheduled jobs

As factory default configuration, no job is defined. They need to be defined by administrators or engineers

Press **+** to start scheduled task configuration dialog

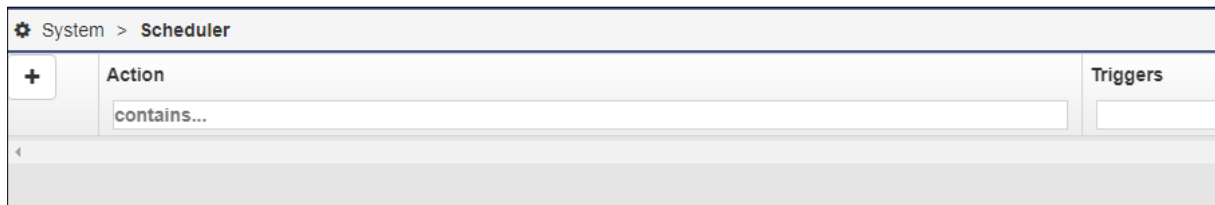

The job configuration dialog is similar to UPS event job configuration dialog. Timing configuration differs due to the fact these jobs have to be triggered independently to UPS alarm states:

Start: enter date and time the job will be executed the first time.

Repeat toggles the job repeating behavior

These values are valid:

One time: only one execution

Daily:

Every day depending on system time

Weekly:

Once a Week depending on system time

Monthly:

Once a month depending on system time

Timing	
Start	08.03.2018 10:52
Repeat	One Time ▾
Triggers	At 10:52 on 3/8/18 one time

Note:

In some cases, jobs can be set ups can vary according the configuration of connected devices.

Webserver

For this configuration step, navigate to the following menus:



Note:

If possible, do not disable the web server!

In order to fit to some high security-compliance conditions, it may be desirable that the web interface of CS141 has to be switched off after configuration work. The CS141 operates exactly "as configured". But it will be a little bit awkward if you need to change or add settings afterwards.

For security reasons, there is no console access. Configuration work will be done via a standardized web interface.

Webserver setting

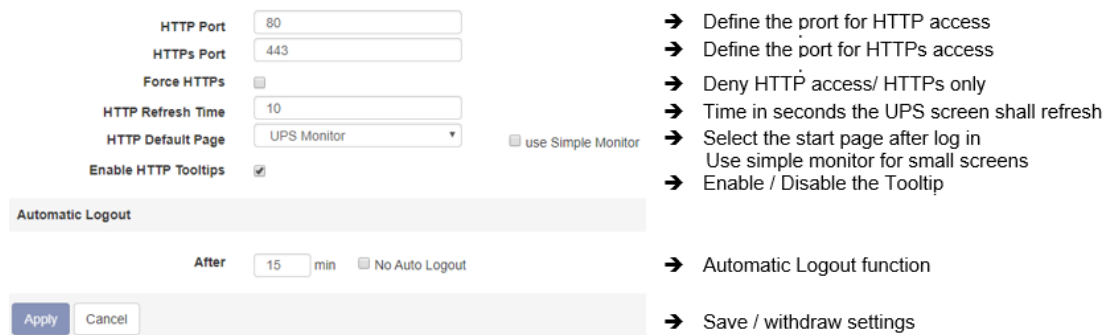

HTTP or HTTPs - Port settings

Setting up the HTTP port

The international standard for web access is port 80 - normally this port does not have to be changed. Anyway, since this is not a fixed standard, your IT infrastructure manager may use settings that differs. If this is necessary, you may use this setting to fit to your IT infrastructure right here.

Please note, if you use a custom port setting, you need to name the according port for web access.

- o 192.168.3.1:85

In this example, the WEBMANAGER will only be accessible at the IP 192.168.3.1 and the port 85. With port 80, you would run into an error message that is generated by your web browser.

The HTTPs Port

In case of using HTTPs, the standard port is port 443. Like the HTTP port, you may use this setting to define custom ports for HTTPs access.

Note:

As soon as force https is active, *https://* is mandatory for a direct web access to the CS141. If you miss to use this syntax, there are two different types of web browser behavior:

Connection Timeout

Since CS141 answers in case of a HTTPS queries, the web browser waits some time and shows a connection timeout issue.

Forwarding (depends on which web browser is in use)

If several CS141 in your network are configured to use https only, your web browser may think you entered the wrong IP address and forwards you to another device.

Force HTTPs

A standard HTTP connection on the Internet can easily be intercepted by intruders. In order to avoid this and to ensure secure data transmission, an HTTPs connection is recommended used. By doing so, the connection is encrypted and the server is authenticated.

The advantage is an increased data security, but at the cost of an increased response time, since the data is transmitted encrypted.

Force HTTPs prevents regular HTTP traffic and enforces to use HTTPs.

HTTP Refresh Time

The CS141 provides dynamic update system status pages. Among other things, these pages display the status and many values of the UPS the CS141 is connected to. By default, the CS141 updates displayed screens every 10 seconds, but you may choose your own refreshing time.

Use simple monitor

The CS141 offers two different displays as a UPS monitor, which differ in terms of layout and content:

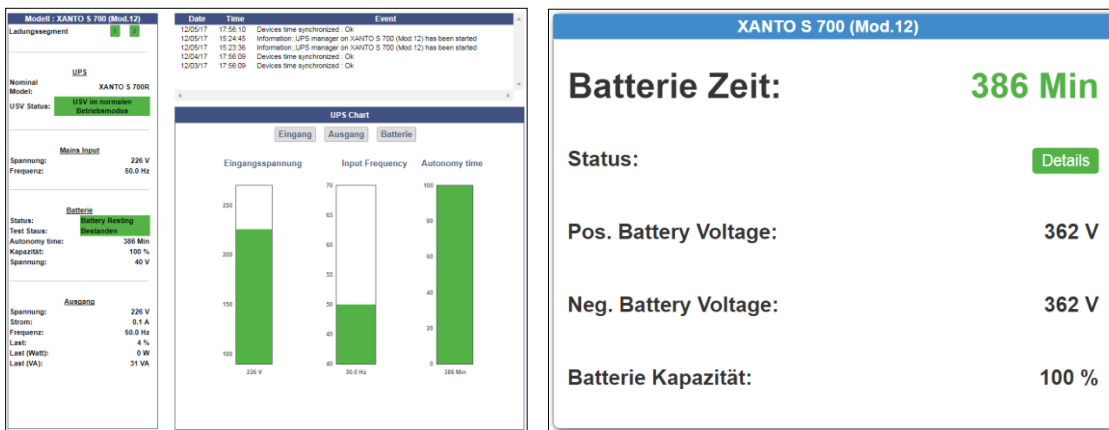

The simple monitor (Fig. Right) contains significantly less information, but better legibility.

Enable HTTP Tool Tips

Tooltips are context-related pop up screens that appear automatically as soon as you move the mouse over a setting option. As a default, the tooltips are enabled. Unchecking this box will disable the tooltips.

How to Enable / Disable the webserver

With Services>Setup, the CS141 provides functions to disable the build-in Web server service.

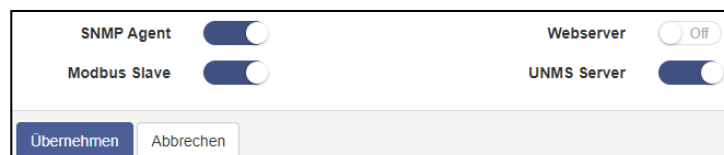

Please note that the complete user interface is linked to the web server - afterwards you cannot carry out any further configuration as well as accessing the monitoring screens. For an access of the user interface, resetting the device to factory defaults is mandatory.

Tutorial: Once upon a time, you switched the web server off...

And now you want to take a look at the monitoring screens and they are gone. Any you do not really know what to do? This tutorial shows you how to reset your CS141 and start over again – the CS141 is not locked up completely ...

Use Backups

“Disable the web server” is very powerful, so it takes a little bit planning before you set the web server restrictively to "OFF": As soon as the web server has been disabled, it will be a little awkward to add some configuration at the CS141 – the current configuration interface is gone. But if you have a backup file you may be able to recover nearly the complete configuration of your device. Which final backup / restore strategy you choose, depends on what you want to achieve.

In principle, there are two basic scenarios:

1. You need to change configuration regularly
Make the full data backup before you disable the web server. You can easily create the backup via the System>Backup configuration.
2. Change a single device that runs “as configured” by a new one
Create a backup file after disabling of the web server. Since the configuration interface is offline, you cannot press System>Backup to create it. So just enter:

`http(s)://<your IP address>/backup`

You will be asked for the standard user name admin and the current password (Standard: cs141-snmp).

Note:

In both cases, the rule is that a backup should only be used with device that comes with the same or a newer firmware version. An older firmware may not work as expected because changes during a firmware update may change the format of backup file, add features or something like that. The older firmware version may not know how to handle these changes.

Using a Backup file

After you have switched off the web server, you can no longer change the configuration. If you do not have a backup now, you will have to completely reconfigure the CS141 after resetting the configuration.

Otherwise, it works as followed:

1. Reset the CS141:
At your web browser, enter this command:

`http(s)://<you IP address>/update`

Even the web server is already disabled, some functions will still work. One of these functions is the direct call of the update window:

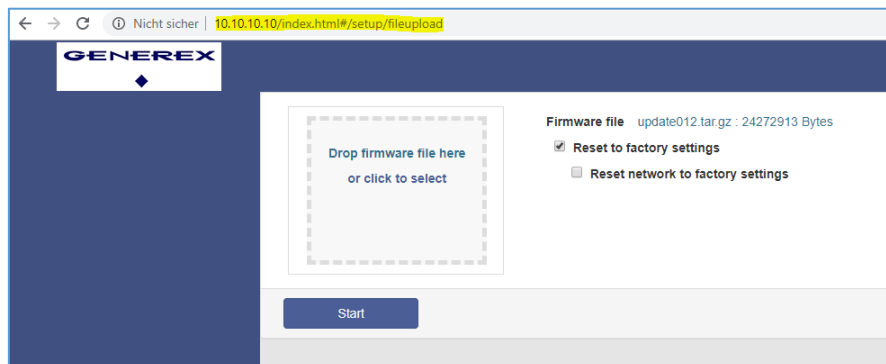

Marking „Reset to factory default will advise the CS141:

- Delete the basic device configuration
- Keep the network settings

After flashing, the CS141 will restart and the web interface is available. Open System>Backup and use drag and drop to place the backup file.

2. Change the device 1:1 by another device / spare part

Open the flash routine as described, and then insert the backup file. Since you have a backup file with a disable web server, the backup will lock up the user interface! You cannot change settings. The new device will run as configured like your old device. Ensure to use all backup file items.

- If you want to refresh a broken configuration file, just use the complete backup file.
- If you want to change the device by a spare part, please note, that you need to depower the original device before powering up the spare part. Otherwise, you may get an IP address conflict.

Tutorial: How to create a *.pem-file

There are many ways to create a key and a certificate. One convenient options is provided by the freeware tool X Certificate and Key Management. In addition to creating valid certificates, this tool also offers options for creating necessary keys at the same time. The created files can then be exported in the correct format. Furthermore, this tool comes with a small database that can be used to manage all keys and certificates in a clear and concise manner:

- - Easy handling
- - Fast key and certificate creation (administration)
- - This tool is available for Windows, Apple and Linux..

Download and Installation

The tool is available via several download sources, a good and clear download is provided by the developer itself:

<https://hohnstaedt.de/xca/>

Please note that download links may change over time and need to be adjusted accordingly.

The setup file contains an installer that guides you through the installation process. Furthermore, this tutorial is based on version 2.4.0! Later versions may differ - keep in mind to adapt your settings.

Creating a Database

This is optional: If you need a one-time self-signed certificate on site, you may choose to skip this step. However, if you would like to generate further certificates at a later date, then it is recommended that you briefly create a local database in which your keys and certificates are stored:

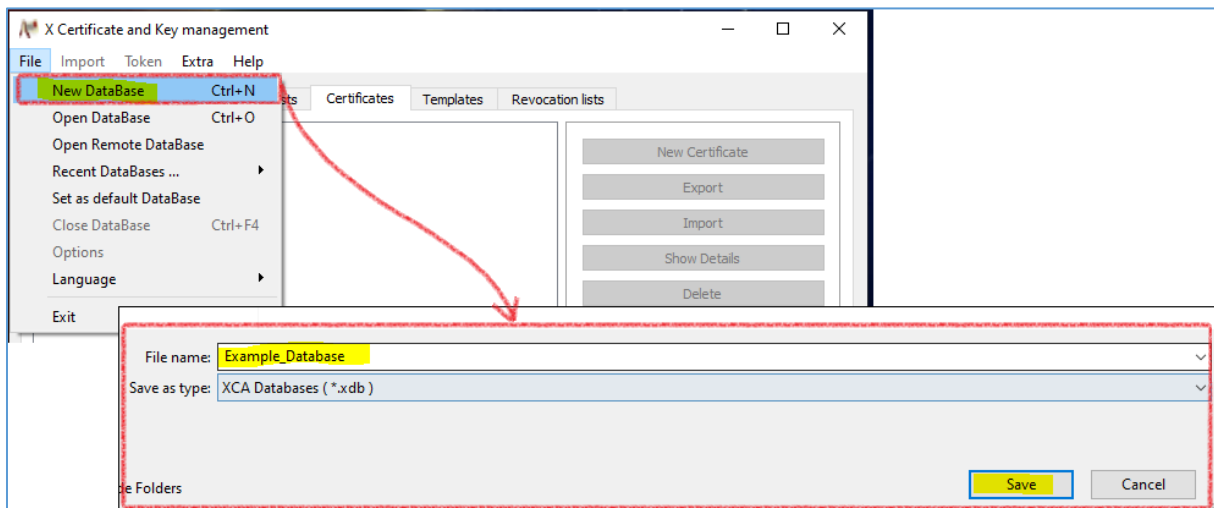

On next start of this tool, select "Open Database" and select the database you want to use to generate new certificates and keys. This will help in case of complex key / certificate setups.

Note: Shall I set a database password?

The tool will ask whether the database should be secured by a password in order to protect against it unauthorized access. This does not harm or effect the keys and certificates created with the tool!

Creating a certificate (Example for Windows, Linux or Apple menues may differ)

When running the programme after installation, it is simply empty, which means there are no sample files to look at first. So open the tab "Certificates" and click on "New Certificate":

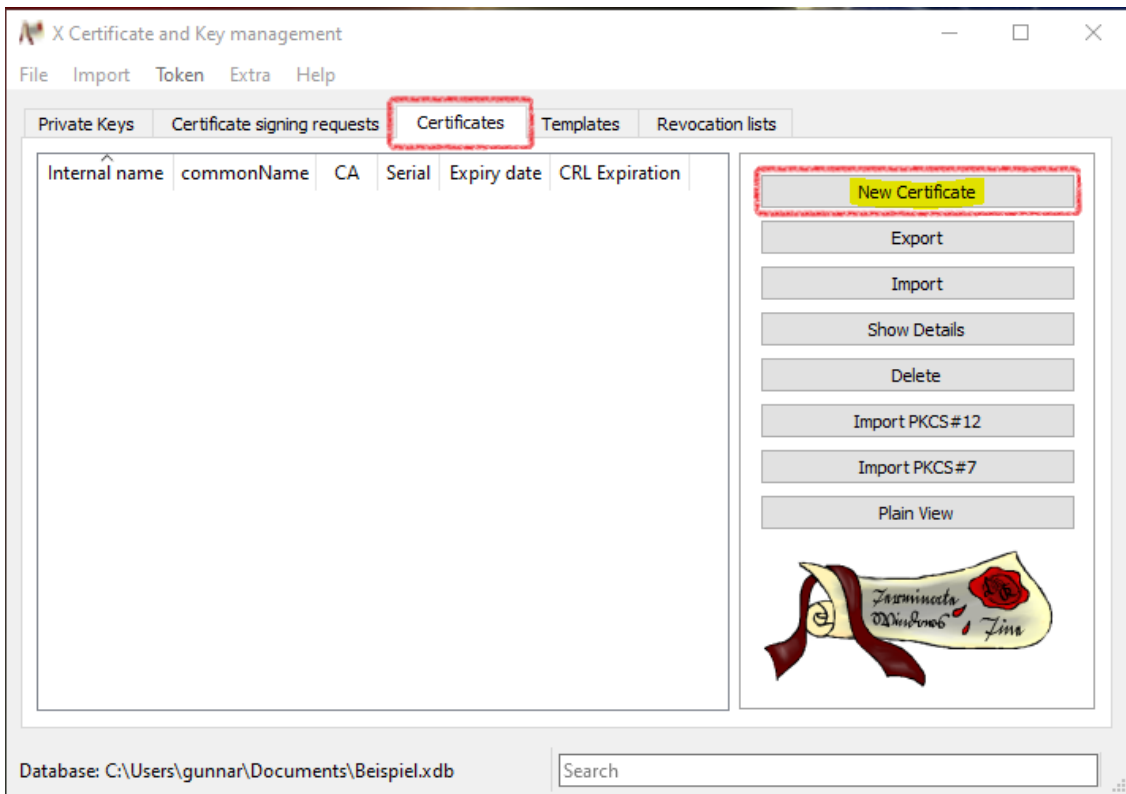

This will trigger a configuration dialogue that will help you to create a self-signed certificate. This tutorial will show you how to use the basic settings needed for CS141. If more or other features are required, please refer to your local system administrator.

Settings at Source:

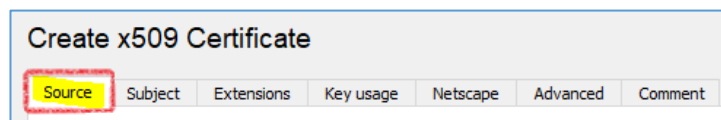

At Signing, please select „Create a self signed certificate“

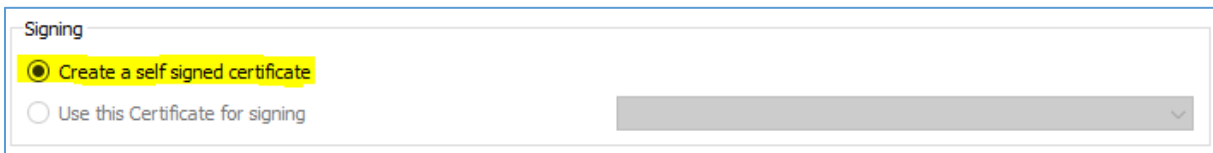

Remember to check whether the default EMPTY TEMPLATE is also active:

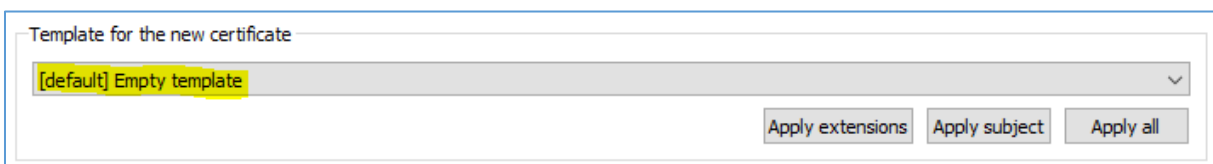

Ignore all other settings, the run out of the box.

Settings at Subject:

Create x509 Certificate

Source **Subject** Extensions Key usage Netscape Advanced Comment

At the tab "Subject", you need to do some configuration work to personalize your certificate.

Internal Name **My Self-Signed Certificate**

Distinguished name

countryName	HH	organizationalUnitName	GENEREX-IT
stateOrProvinceName	DE	commonName	YOURDOMAIN.LOCAL
localityName	IT Department	emailAddress	support@generex.de
organizationName	GENEREX		

Internal Name:

This entry is for internal use only. If a database is available, the tool save this name and show this at the main window.

Distinguished name

Personalize your certificate by filling up the fields. Keep in mind, for a host certificate, the "commonName" must be the FQDN (Full Qualified Domain Name) you want to use the certificate for.

Generate or choose the key for your certificate

Private key

Used keys too **Generate a new key**

Either select the key you want to use, or - if you have not yet generated a key - click on "Generate a new key" to make it so:

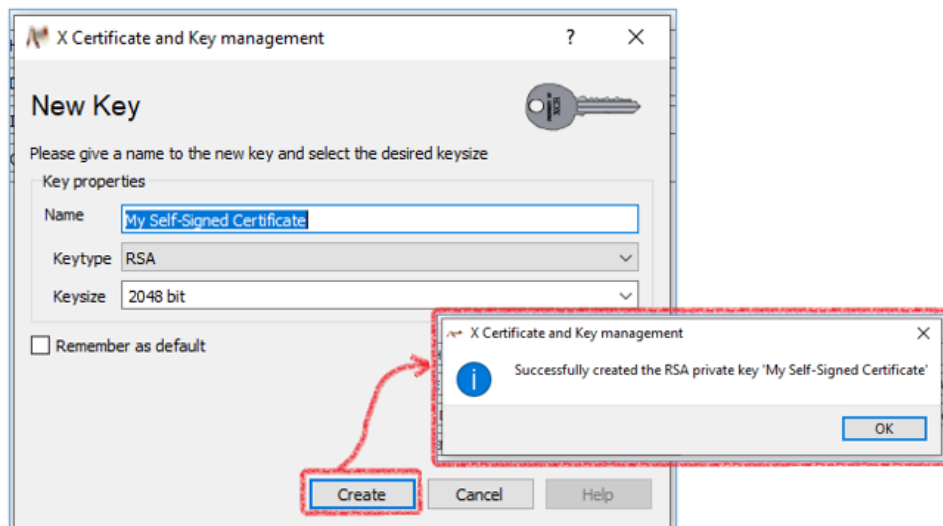

Click on "Create" to build the key. It should now be automatically selected at "Private Key":

Private key

My Self-Signed Certificate (RSA:2048 bit) Used keys too

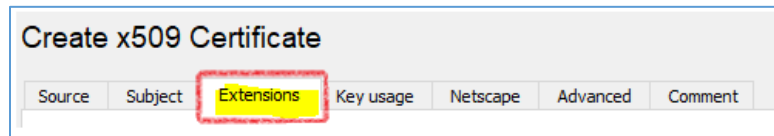
Settings at Extentions:

For this tutorial, the only setting you need to change, is „Validity“: This configuration determines how long your certificate will be valid and can be used. As a standard, devices can be configured to reject invalid certificates. Adapt the time settings to fit to your IT security guidelines.

Validity		Time range	
Not before	2022-10-18 12:31 W. Europe	1	Years
Not after	2023-10-18 12:31 W. Europe	<input type="checkbox"/> Midnight	<input checked="" type="checkbox"/> Local time
		<input type="checkbox"/> No well-defined expiration	Apply

Create the certificate:

This is quite simple: If configuration is done, simply click OK to generate the certificate. Since there are no further optional extensions added to the certificate, the tool will ask you to verify that the certificate will be carried out correct.

Since we know, it is correct in this case, click Continue rollout and move on:

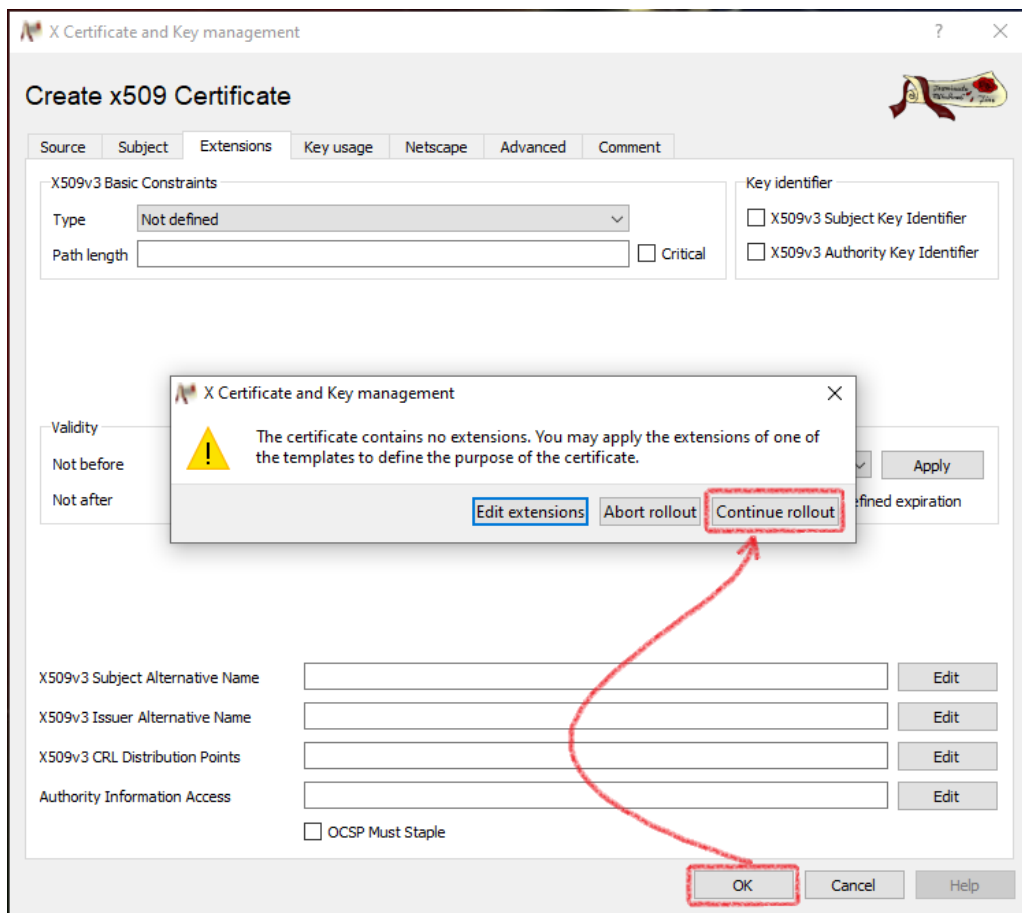

The certificate will appear at “Certificates” and ready to use.

Export the certificate

The next question is: How to get the certificate out of the tool and create a *.pem – file the CS141 can use?

We..., the recently created certificate should now appear at the tab "Certificates". To export the certificate, select it and click "Export":

At export dialogue, select PEM + key (*.pem) as the export format. Then rename the file to "server.pem" - this is the file name needed for the CS141.

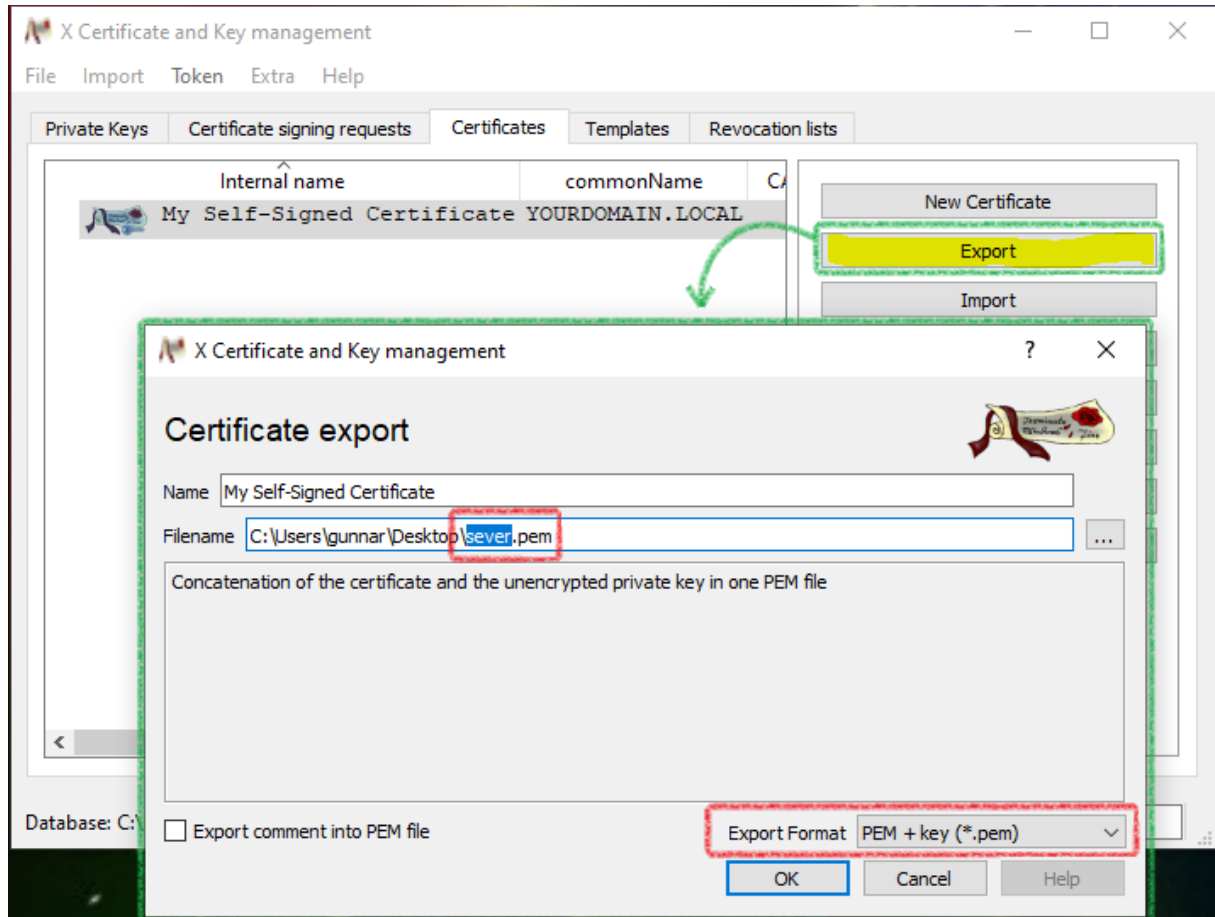

Check the server.pem

Open the PEM file with a simple text editor. It should look like this:

```

*server - Notepad
File Edit Format View Help
-----BEGIN RSA PRIVATE KEY-----
MIIEogIBAAKCAQEA3rv8IvVx3EZbMnwDBMK/b8dj71s8QDLQ/gkr2/ro5ACRYrOD
3ZLKRZH/1KXG8zdB6Qo49tUT+/oWFzv4NGjSGQfyLXS1UhrKc6fC9LDqOvPru7f2
[...]
9m8GytJ64WfVakAukf2Ajo1+F0FqIvF5Vg/ONvvAB4zNh78puwYNwzJFNYiVbduK
jsGJ3dQrM9NiyfK8rV2i5y1Jh0pa7vUwdUPaW08yGKaMGsnYK2E=
-----END RSA PRIVATE KEY-----
-----BEGIN CERTIFICATE-----
MIIDnjCCAoagAwIBAgIIN1JX/DWbm8owDQYJKoZIhvcNAQELBQAwY4xCzAJBgNV
BAYTAkhIMQswCQYDVQQIEwJERTEQMA4GA1UEBxMHR0VORVJFWDEQMA4GA1UEChMH
[...]
fyUGUnf6p/pCWLo/vkxm0L3tjVg3QC1/wTRZ+t3iJ8KKQs6egE17rys1XkLoMS
yv7s9k9RQ1F9ykXTJRKmOoGT
-----END CERTIFICATE-----

```

Note: Can I use another tool than this one?

Yes, you can! The tool presented is merely an example to show and explain how to create a basic pem-file. For more functions and options your IT infrastructure may require, please refer to your local administrator.

Uploading the certificate to the CS141

Open the web interface of the CS141:

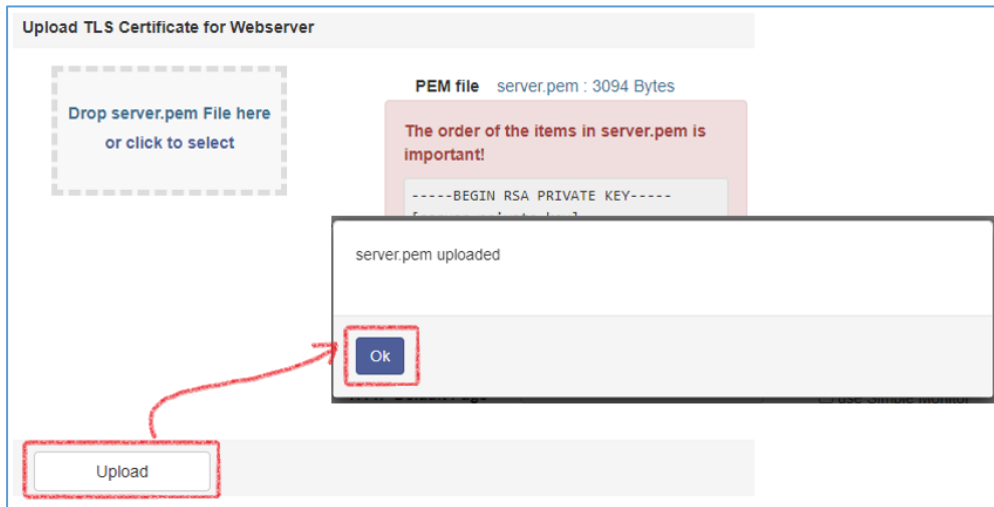

Drag'n'drop the file server.pem into the according upload box and press Upload. After Upload, the CS141 needs a reboot to import and activate the certificate. Go to System>Tools and click on reboot. Since the UPS is a complete different device, this button only restart the CS141.

After Reboot, you can simply check it by testing with:

http://<Ihre IP-Adresse>

https://<Ihre IP-Adresse>

If both requests are available and work as expected, feel free to enable explicit https encryption with "Force https".

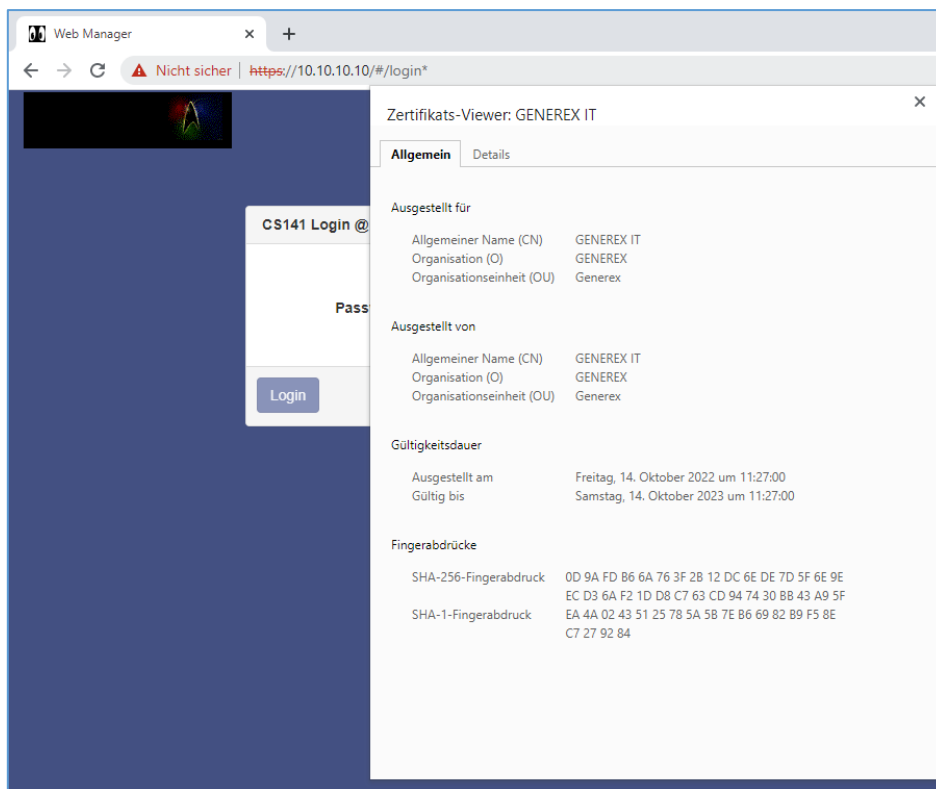

Diagnostic: Status LED's

The CS141 offers several options for diagnosis. The fastest method is a quick visual inspection of the LEDs

To perform a quick inspection, take a look at the two LEDs in front of the CS141:

Green LED	Red LED	Adapter
OFF	OFF	No Power
OFF	AN	Boot in progress
OFF	SLOW BLINKING	Update in progress
AUS	FAST BLINKING	Update failure
ON	ON	Communication lost: UPS or external device
SLOW BLINKING	OFF	Everything is OK with the world

After logging in, the CS141 will display a more detailed overview of the current system state:

UPS:  Ready

A green marker indicates communication without problems.

Please note the setting no UPS device selected will show a dummy screen and the LED will also be green.

UPS:  Initializing

A yellow marker is displayed if:

- - The device will initialize and the communication is being established
- - there is a warning behavior. It might be required appropriate intervention in the near future.

UPS:  Temperature Bad

If the LED is red, an alarm or critical condition is currently detected:

- The CS141 has lost communication with a connected device
- There is a system critical condition, which requires a timely intervention.

The type of the alarm is displayed in detail.

UPS:  Communications Lost

A blue marker indicates that the device was probably configured correctly, but no initial communication has been established.

Sensor:  Disabled

A gray marker and the description disabled means that a device has been completely deactivated and cannot provide any data.

Example: Quick diagnosis using LEDs and marker

At the front of the CS141 both, red and green LED's, are on, but they should be off or just the green one flashing slowly. The UPS is definitely recognized ... and seems to work normally.

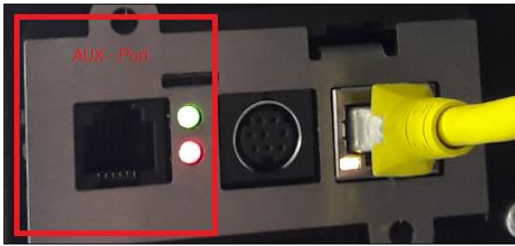

As you can see the red and the green LEDs are lit statically. Since it is a slot card, it is plugged into the UPS and is supplied with the necessary information about it.
The yellow plug is the ethernet cable to connect the CS141 to the local network

In this example scenario, the AUX port is the cause of a communication error:

After logging into the CS141, the top status bar displays the following information about enabled devices:

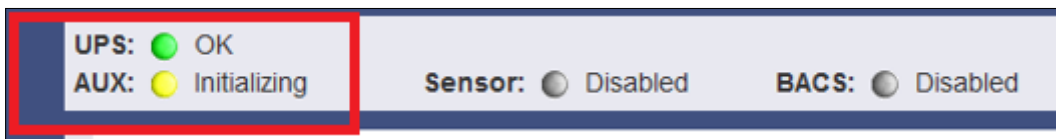

The UPS is set correctly and has made the communication accordingly. The AUX port, on the other hand, is set to initializing. However, since the AUX port has no device connected to CS141, the yellow marker will change from yellow to blue in time, while the LEDs on the front of the CS141 continue to glow green and red statically.

Due to the fact the UPS indicates a green marker and other devices are set to disabled, the AUX-Port will cause trouble.

What you can do:

Once a CON_AUX4 or CON_R_AUX4 device has been connected to the AUX port of the CS141 and successfully initialized, the marker in the status bar will turn to green and provide feedback with OK. Furthermore, the LED status at CS141 will indicate normal operating mode.

If no AUX device is to be used, you can set the AUX port at COM3 to none in the general configuration menu.

In this case, the AUX port will be disabled as well as the AUX marker will be removed from the top status bar.

As a consequence, the LED at CS141 will indicate normal operating mode.

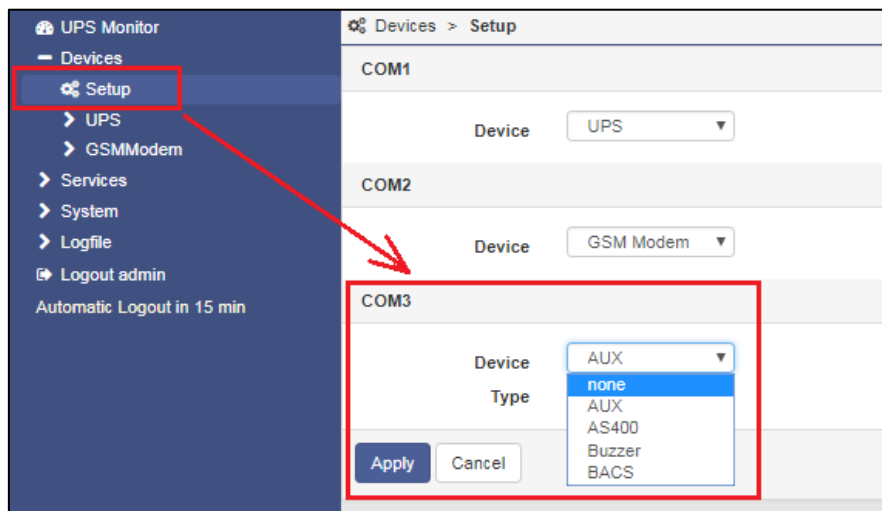

Logfiles

Event Log

Since this is not a configuration step, just navigate to the following menu:

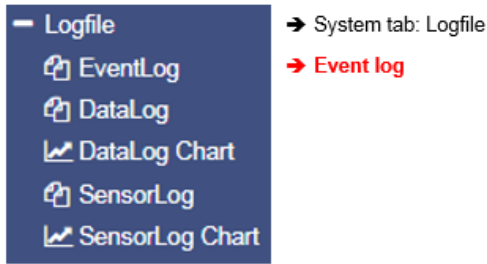

The event log contains all actions concerning the CS141 and the UPS are recorded. The event history will be written by any event containing a log job. The most significant jobs are included by default settings. Administrators may create, edit and delete default settings as well as creating custom log entries.

Logtime	Logtext
<input type="text" value="Logtime search"/>	<input type="text" value="Logtext search ..."/>
12/07/2017,09:38:01	time synchronization job : OK
12/07/2017,09:38:01	Restart NTP service: OK
12/07/2017,09:33:45	UPSMAN on No UPS model defined has started
12/07/2017,09:33:25	CS141L V1.63 - OEM 32

[Download als CSV Datei](#)

After reboot the first entry is a message by CS141 with its OEM ID:

12/07/2017,09:33:25	CS141L V1.63 - OEM 32
---------------------	-----------------------

Please note the latest entry is always on top of the list. Download as CSV file creates a CSV file from this event log and stores it locally on your hard disk:

DataLog	04.10.2017 13:45	MICROSOFT EXCEL-C...	400 KB
eventlog	07.12.2017 10:45	Microsoft Excel-C...	1 KB

Any program that can deal with CSV files can be used to open the event log.

	A	B
1	12/07/2017,09:33:25, CS141L V1.63 - OEM 32	
2	12/07/2017,09:33:45, UPSMAN on No UPS model defined has started	
3	12/07/2017,09:38:01, Restart NTP service: OK	
4	12/07/2017,09:38:01, time synchronization job : OK	
5		
6		

In case of current memory to store event, logs are exhausted, the CS141 will open an archive file and move the current event log. This archive file will be provided for both: downloading as well as instant view.

Note:

Depending on the configuration, the system events in the event log are kept for up to three months. As soon as the running memory for the current event log file is exhausted, the files are stored alternately in up to two archive files. This generally provides a monitored period of up to 9 months from initial startup.

Navigate between logfiles

By default, the current event log is displayed

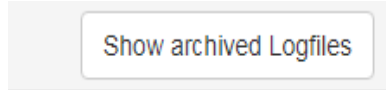

Administrators are able to toggle between the two logs by clicking the button "Show archived Logfiles" in the upper right corner.

By doing so, the label of this button will change:

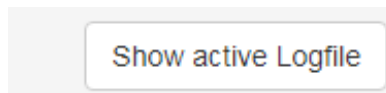

To return to the active log file, press the button labeled "Show active log file"

Data Log

Since this is not a configuration step, just navigate to the following menu:

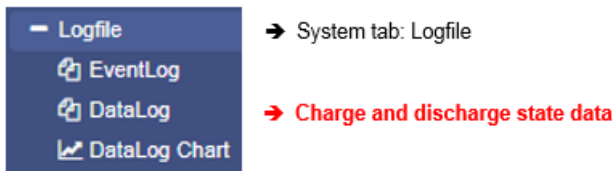

Logfile > DataLog																
↻																
Date,Time	InVolt1	InVolt2	InVolt3	InFreq	Load1	Load2	Load3	BattVolt	UPSTemp	BattCap	OutVolt1	OutVolt2	OutVolt3	OutFreq	AutonomTime	
01/01/2000,00:04:51	n/a	n/a	n/a	n/a	n/a	n/a	n/a	n/a	n/a	n/a	n/a	n/a	n/a	n/a	n/a	6.0
01/01/2000,00:07:59	230.0	230.0	230.0	230.0	50.0	100.0	n/a	n/a	n/a	n/a	100.0	n/a	n/a	n/a	n/a	6.0
01/01/2000,00:11:06	230.0	230.0	230.0	230.0	50.0	100.0	n/a	n/a	n/a	n/a	100.0	n/a	n/a	n/a	n/a	6.0
01/01/2000,00:14:16	230.0	230.0	230.0	230.0	50.0	100.0	n/a	n/a	n/a	n/a	100.0	n/a	n/a	n/a	n/a	6.0
01/01/2000,00:17:23	230.0	230.0	230.0	230.0	50.0	100.0	n/a	n/a	n/a	n/a	100.0	n/a	n/a	n/a	n/a	6.0
01/01/2000,00:20:31	230.0	230.0	230.0	230.0	50.0	100.0	n/a	n/a	n/a	n/a	100.0	n/a	n/a	n/a	n/a	6.0
01/01/2000,00:23:39	230.0	230.0	230.0	230.0	50.0	100.0	n/a	n/a	n/a	n/a	100.0	n/a	n/a	n/a	n/a	6.0

The data log recognizes measurement data of the UPS. Due to the fact these are provided with a time stamp, they can be combined with the event log:

Analysts can build event chains with additional UPS data.

Like the event log, data log can be exported as CSV file as data backup. The data log stores the entries every 3 minutes and keeps the entries 8 weeks as the current data log file. After that the actual data log will be moved to an archive file and a new data log for the current data is opened.

The CS141 provides storing up to 2 independent archive files:

In addition to the current period, there are up to 24 weeks available. After expiry of the time, the oldest archive file is replaced. As with the event log, administrators can toggle between active log and achieved logfiles.

Data log Diagram

Since this is not a configuration step, just navigate to the following menu:

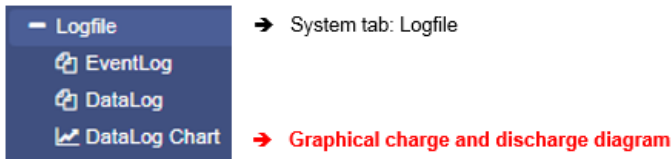

With data log Chart CS141 provides a graphical presentation of the battery history:

This feature allows to examine all entries within the data log exclusively. Single entries can be selected by using checkboxes:

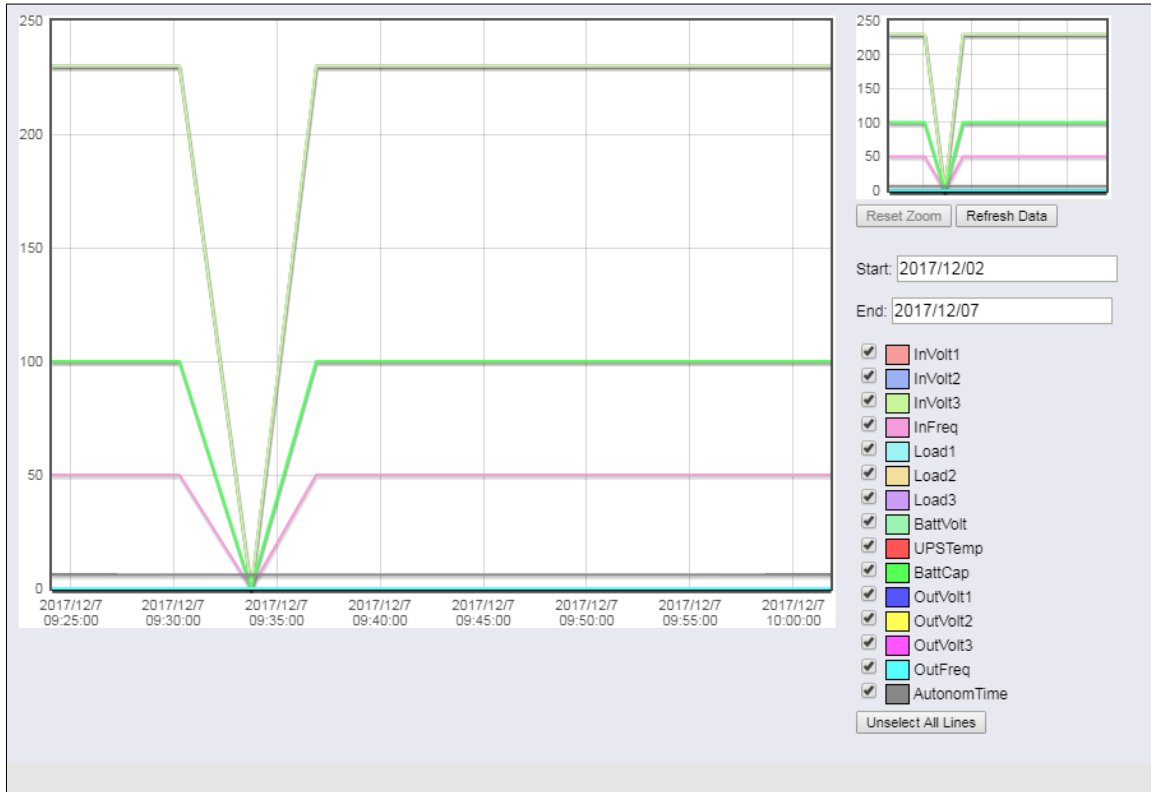

In addition to the current values, the CS141 provides selecting specific values from current databases.

As a default, all check marks are set when called. You can use the Unselect All Lines function to remove them and set the relevant checkmarks.

How to use the calendar

The calendar feature provides a quick overview of existing time periods that are selectable. Click the date field to bring up the calendar:

The dates of the corresponding period are automatically loaded and displayed inside the main window.

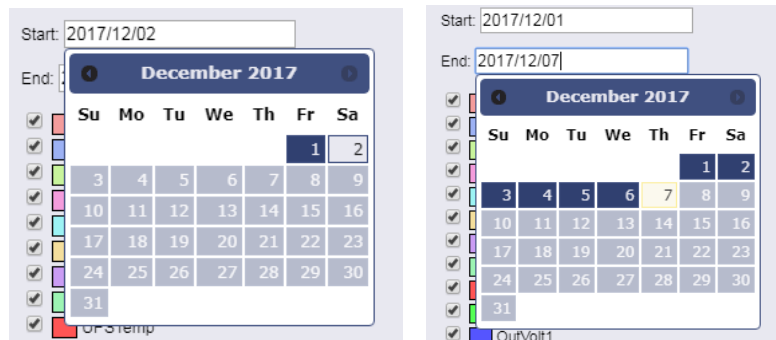

Zoom the Chart

The CS141 provides zooming the data and thus obtain a detailed view within the displayed measurement data.

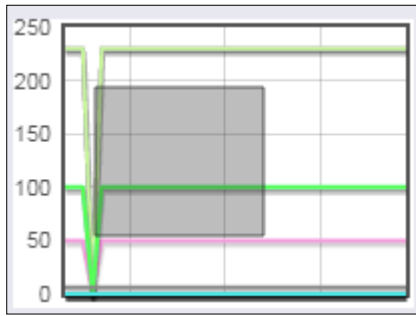

To refine display, drag a frame inside the small window. The main window will automatically show a detailed view und provide a customized timeline.

The zoom function allows an enlargement of the timeline up to 2 minutes.

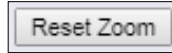

This function resets the zoom back to the original scope.

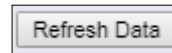

This function updates the current data shown and refocuses the timeline.

Premium function: The UPS alert history

This menu is only available if your UPS will support the functionality
 Since this is not a configuration step, just navigate to the following menu:

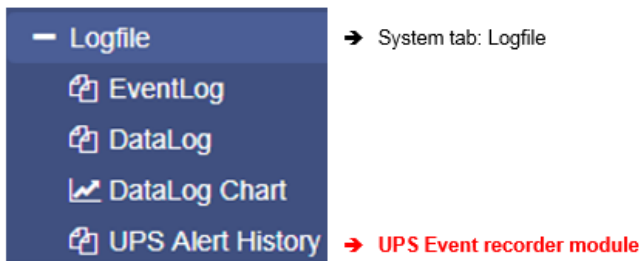

Not only the CS141 logs events - many UPS systems provide their own internal non-volatile memory to log events as well as internals. This information can provide very useful insights if irregularities occur after a configuration.

Note

The CS141 adapts itself to functions a UPS provides - The UPS Alert History is only available if your UPS supports this function.

Reading internal event logs of the UPS

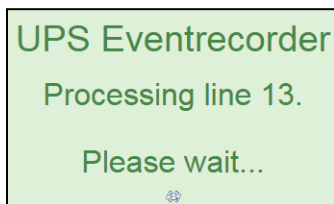

Each time the UPS Alert History button is pressed, the event memory of the UPS read out and displayed accordingly.

Please note that displayed status messages as well as the scope and information value may vary:

Some UPS models provide more useful information than others.

After reading, UPS data are displayed inside a chronologically arranged history. At the top of the list, you will find the oldest UPS log entries. At the bottom of the list, the latest entries will be shown.

```
2018/05/30 14:42:28.780 Event #298: ABM testing
2018/06/05 14:02:54.000 Event #290: Clock set
2018/06/11 10:06:07.610 Event #139: Inverter off
2018/06/11 10:06:07.610 Event #294: UPS off
2018/06/11 10:48:57.130 Event #139: Inverter on
2018/06/11 10:48:57.130 Event #298: ABM discharging
2018/06/11 10:48:57.170 Event #237: UPS on normal
End
```

End determines the last entry of the logfile.

Exporting UPS data log

If needed for later analysis for statistical and diagnostic purposes, the CS141 provides to export and save the log as CSV file and save it locally to your hard disk



Note:

The UPS Event Recorder polls the current list from the UPS with each call - These log data will not be cached or saved by CS141.

Tools

The GENEREX system tools are a collection of useful utilities to help in case of diagnostic problems. To ensure authorized access only, this menu acquire administrative credentials:

To open the Toolbox, navigate to the following menu:

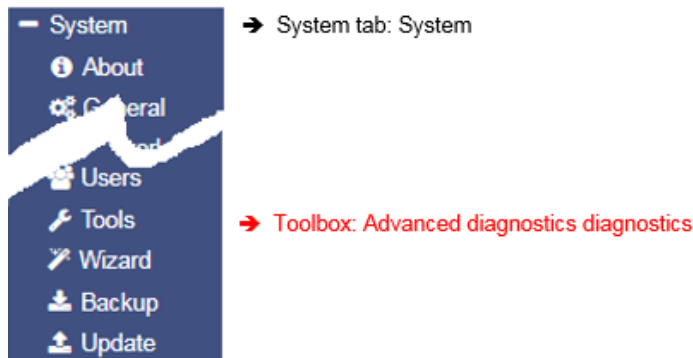

Reboot

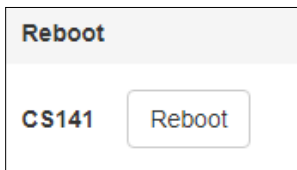

Due to the fact the CS141 accept changes inside the configuration and start or restarts the corresponding system services in real time, a complete restart is an exceptional situation. In case of a restart of the CS141, UPS continues its normal mode: A reboot of CS141 does not affect the UPS. To prevent an accidental triggered reboot, this feature was deliberately placed inside *Tools*.

Tracer

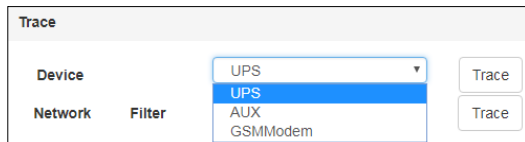

The Tracer is a comprehensive diagnostic tool for verifying communication between the CS141 and the connected devices as well as for identifying network problems.

Under Device communication information about external devices connected to CS141 can be queried. To track a device, open the

context menu and select the device you want to monitor. As the screenshot illustrates, the CS141 provides COM 1 / UPS, COM 2 / GSMModem and COM 3 / AUX-Port:

COM 1/ UPS

The tracer will screen the current communication running at the serial RS232 port. Faults or faulty communication are displayed in real time and can be saved for later evaluation

COM 2 / GSM-Modem

The Tracer queries the communication between the CS141 and the GSM modem and displays the telemetry in real time. Errors and communication problems can be easily collected and saved for later analysis.

COM 3 / AUX

A CON_AUX4 or CON_R_AUX4 can be connected via the AUX port. The tracer can interrogate communication with the device in real time.

Note:

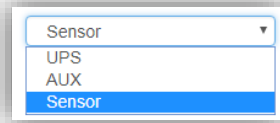

The Tracer adapts itself to the choice met under Devices in the configured in general port settings. If sensors or a Sensor manager 2 is configured instead of a GSM modem, the tracer will show these devices.

The button labeled with Trace starts the process. Depending on your browser's configuration an open a new tab will be opened to show the data stream of the communication between the device and the CS141:

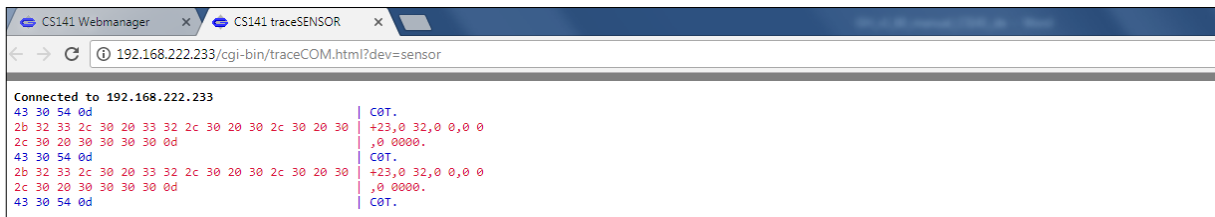

The trace ends automatically by closing this tab. Please note that the data will be discarded. To save the data, mark it with the left mouse button and copy the content with CTRL + C, and insert the information with CTRL + V to a text file.

Available Tracing tool control options

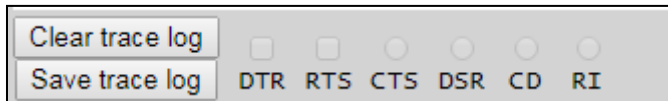

- *Clear trace log*

Clear trace log deletes the current display - the information cannot be recovered afterwards.

- *Save trace log*

This function will transfer the current browser content into a standardized text file.

Note

This log file contains the complete time-stamped communication between the CS141 and UPS connected to it: The CS141 asks and the UPS responds accordingly. Since these entries are time stamped, this communication may be compared to external events - this valuable information may help finding the cause of an incident.

The telemetry data file is placed in real time inside the memory of the web browser. By closing this window, the trace data file is automatically terminated and lost. Ensure saving data before closing the window of the web browser.

Trace file evaluation

Open the saved text file. Please note the extended text formatting - Ensure to use a text editor mastering extended text formatting. As an example, typical applications would be editors like sublime or the editor write by Microsoft Windows.

For a detailed analysis, the official protocol description of the UPS is necessary.

For further details, please refer to the manufacturer of your UPS.

Network-Scan

As special feature the CS141 provides an integrated network scanner to examine the LAN for issues and errors. The network scan provides extensive information for evaluation about the network the CS141 is connected to. All data packets are collected in a log file. After network scan, the network log can be downloaded for evaluation.

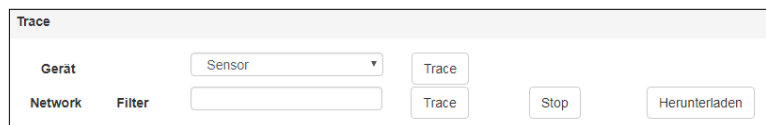

Privacy Policy:

Since the network scan records all traffic in this network segment the CS141 is connected to, an evaluation with a corresponding network tool can be used to find error. Furthermore, deep insights into the network traffic are available, e.g. to log the user behavior. Technicians should inform the respective responsible person before use.

To perform a network scan, click on the Trace button in the Network line. The tracer will confirm tracing activity with a short fade in.

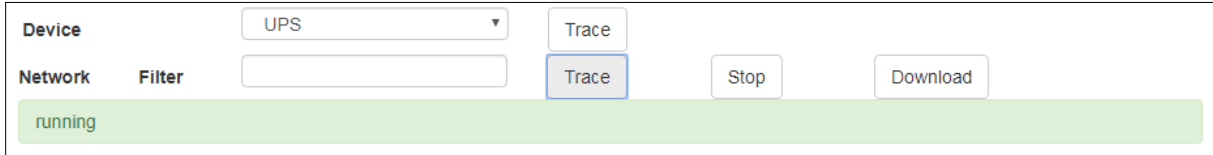

The Tracer logs packet data within the LAN segment in real-time and stores it locally on the CS141. The tracer will quit if there are two conditions:

1. A reboot (expected / unexpected)
2. By pressing the Stop button

After finishing, the data will be downloaded in the form of a packed archive for later evaluation.

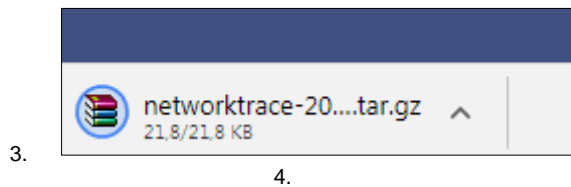

Note:
 The network tracer is usually very rarely needed. In seldom cases GENEREX technical support needs specific additional information to locate a problem.
 In this case, it is recommended to start the tracer without using filtering options. Furthermore, it turns your CS141 into a powerful network diagnostic tool that lets you examine your local LAN:
 Refer www.tcpdump.org to find extensive tutorials how to define filters in order to use the full potential of the CS141 as a network diagnostic system.

Data evaluation

The data analyzed via diagnostic tools such as Wireshark *:

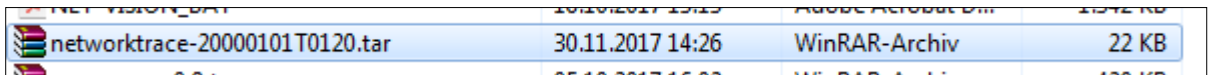

Downloaded data can be read and analyzed by special diagnostic tools such as Wireshark *:

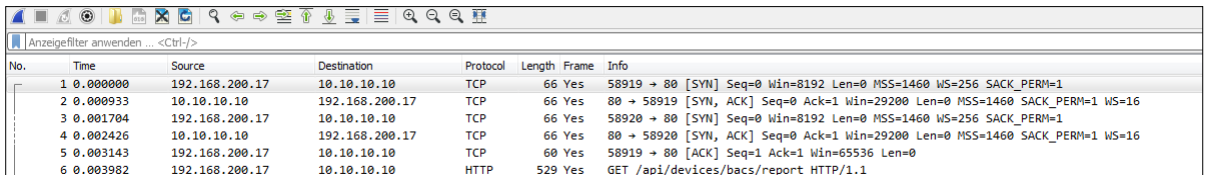

*Wireshark is not a GENEREX product. It is available at www.wireshark.org

Delete log files

The CS141 collects and logs many data and uses non-volatile memory to store it permanently:

These data can then be retrieved via a web browser or evaluated by diagnostic tools. Since the log files may contain very sensitive information about a network state, it is recommended to delete all data before re-using the CS141 Webmanager.

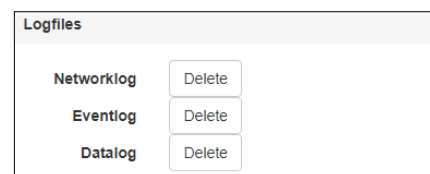

Networklog

Deletes any network trace data

Eventlog

Deletes all logged data according to events

Datalog

Deletes additional data of UPS measurements.

Note

Once deleted, the logfiles are gone with the wind! Normally, the CS141 provides enough space to store the data a complete lifetime cycle. If in doubt, ensure a backup of the data files is available. Please note, there is no option to recover data on the device itself.

Tutorial: Complete data delete routine

As a web manager, the CS141 provides a large amount of data about installed devices to ensure deep analysis in case of incidents:

- Battery data
- Sensor data
- Event Logs
- Transmit / receive confirmations
- [...]

The exact data collected by the CS141 Webmanager depends on the hardware connected to it as well as the state of configuration. However, as these data may contain both, very sensitive information about the security concept of an IT infrastructure and clearly reconstructable chain of events, a complete data deletion is recommended in case of a reorientation to new tasks.:

As an example, if the CS141 shall be sold, all user traces should be removed completely.

Where are log files stored?

In principle, these log files can be found in two places:

1. The regular operating mode

The current log files are created in real time and managed accordingly. If you intentionally delete these files via the toolbox, they are lost - data recovery is not possible

2. The Rescue Mode

As soon as you perform a system update in any form, the existing data and configurations are parked in the Rescue Mode as "last known good". The regular operating mode is set back to 0 and starts after a successful flashing with a new set of log files. Due to this fact, the CS141 provides even an emergency data rescue option:

After an accidental flash, the rescue mode will allow to access log files as well as the last existing configuration since the previous planned firmware flash.

Complete removal of all user traces

To completely erase all data, first set the slide switch to center position to enable the configuration mode and its hard-coded IP address 10.10.10.10 and the subnet mask 255.255.255.0. Make sure that you have assigned a suitable IP address to your computer or enter a corresponding route to access the CS141. Carry out two flash updates in a row. Ensure both cases the checkboxes are selected: Factory default and network reset.

The first flash update transfers data and configuration from the regular operating mode to the Rescue mode and deletes all data during the subsequent flash process. The second flash update transfers the completely empty configuration from the configuration mode to the rescue mode.

Note

Type <http://10.10.10.10/update> in the browser and run the flash update after entering the current administrator password. On the second pass, the default password cs141-snmip is active

Change the logo

Some companies do not want foreign logos inside their IT Infrastructure. Therefore, it is possible to change the logo shown on the upper left side.

How to change the logo

1. Open the graphic program of your choice
2. Create a new picture, maximum size is 200 X 54 PX

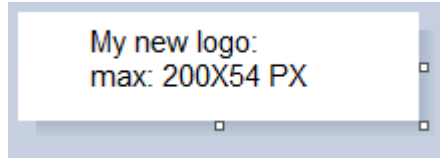

3. Edit the logo as your wish
4. When finished, save the logo with filename logo.gif – otherwise it will not work.
5. Open CS141 Toolbox:

Under Tools, you will find the configuration screen:

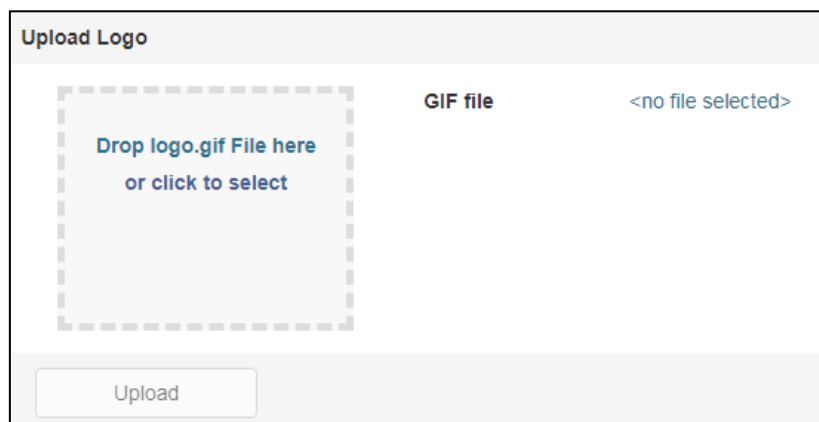

Use drag and drop to insert the new logo or click to select from a list.

6. Press Upload to insert the new logo.

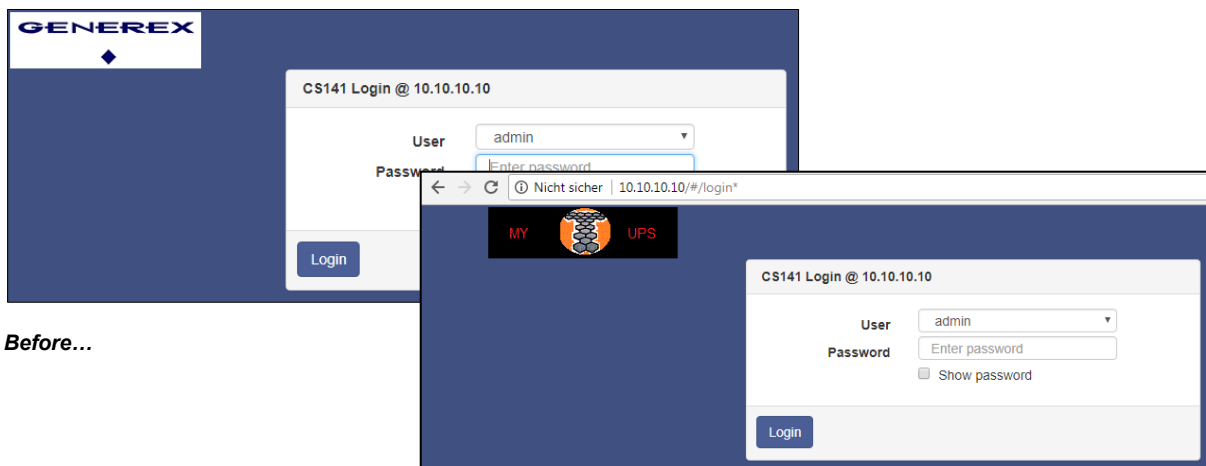

Before...

... and after

Data backup and firmware update

For this configuration step, navigate to the following menus

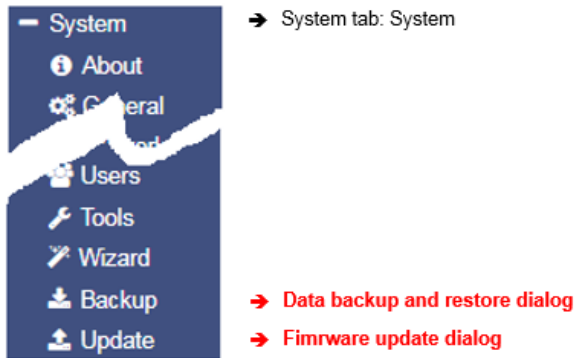

Data backup offers the option of completely backing up the current system configuration in order to quickly perform a recovery if required. The backup and restore will be done in two steps:

Step 1: Perform a backup

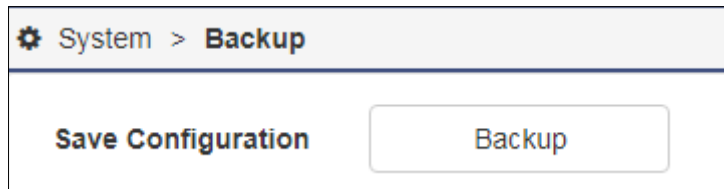

Open *Backup*. Under Save Configuration, click Backup to locally save a backup file to your download directory. Since the backup function is system-critical, CS141 asks for the valid administrator password.



This data backup can be run with any CS141 using a similar or higher OEM firmware version. Please note, renaming the backup file is subject to some restrictions that may lead into an invalid restore procedure:

[backup-200001707T0416.tar.gz](#)

For changing the name of the backup file, please note the hints as followed:

- You need the packed file as downloaded.
- The area marked in red cannot be changed
- No spaces inside the file name
- No special characters

Step 2: Restoring data

Importing a backup will use the same menu:

Use drag'n'drop to place the packed file into the box or left click on the box to open a file browser and double-click on the desired backup file. With Restore, the recovery process will be triggered. During recovery process, CS141 unpacks the file and automatically takes over as a current configuration. After completing the process, you will automatically be logged out and have to re-login with credentials according to the backup.

Restoring network data

Restore network settings

If you back up multiple identically configured web managers, you can exclude IP address settings from recovery. By doing so, previously configured IP address entries will persist while restoring all other configurations.

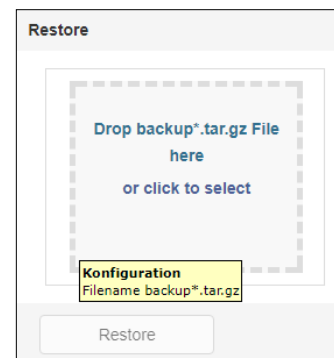

Please note that backups from a CS141 are compatible with any CS141 of the same or later firmware: If you use the backup on a CS141 with an older firmware, problems may arise. This behavior is reasoned by general improvements as well as new features older firmware versions cannot work properly with. In some cases, it is possible the backup does not work.

Firmware updates

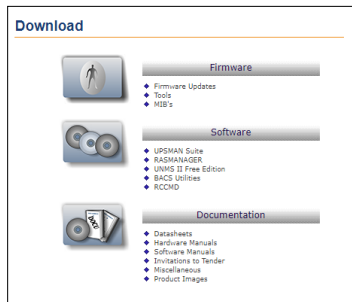

Firmware updates can be found at www.generex.de by following the download area. These System updates are regularly provided for the CS141. In addition to general product enhancements such as increased stability and improvements in operational and reliability, these updates also regularly provide new features that integrate seamlessly to existing configurations.

By default, the OEM ID 12 / GENEREX is preinstalled on delivery.

Deviations will result if you have purchased the Web Manager as part of a UPS from a manufacturer that comes with OEM agreements.

Note:

Due to the fact CS141 is not technically locked, you can install the OEM version of another manufacturer at any time. In case of another UPS is used, just install an according OEM firmware version.

Under Firmware, select the version you need to use and download it to your computer. Unpacking the file is not necessary.

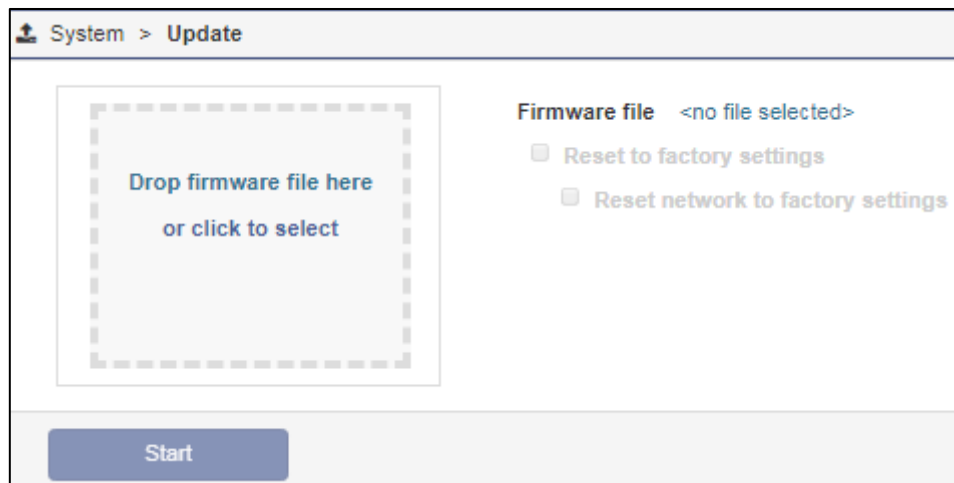

After downloading, open the web interface of the CS141 and open *Update*:

Drag the downloaded, packed file directly to the provided window. With Start will trigger the update process. Before triggering the update with Start button, you can select the following additional options:

Reset to factory settings

This option deletes all configurations during the update and returns the device to the delivery state.

Reset the network to factory settings

This option also resets the network and IP settings to factory defaults.

Note:

These two options are independent to each other to ensure not losing the IP settings. Due to this fact a factory reset using a remote access to the CS141 is possible. Please note Reset network to factory settings needs to be de-selected if CS141 has to hold its IP settings

Since the update is interactive, please remain on the page until you are prompted to restart the device. Under system, open about menu to check the success of the update.

General note: Please read before flashing:

In general we recommend to use the latest firmware version:

The latest firmware version provides product improvements, new UPS models and bug fixes. Additionally, the ongoing development process allows to deploy regularly new functions. This ongoing development process includes to update core components or file systems, too.

Unfortunately, some changes need are deep inside the core system. With firmware 1.82 such a step is necessary:

1. You can always update to the firmware version 1.82 or later.
2. After the update is finished, a downgrade is only allowed until firmware version 1.82.

If you want to test the new firmware on an existing device first:

In case of a regular firmware update, the update routine will move the currently used firmware version to the rescue system as so-called "last-known-good". By doing so, you have an optional way for downgrading as long as you have not stored the firmware 1.82 as rescue mode.

How to use the rescue system can be found in the chapter "Starting the rescue system".

Although we do not recommend to use old firmware versions - if it is necessary that you need an older firmware version, please contact us: support@generex.de - our support team will try help you in this special case.

Changing OEM Firmware

The CS141 Webmanager comes in two different firmware versions:

- GENEREX - ID 12
- OEM version of the manufacturer of your UPS

If you cannot find your UPS in the list of selectable UPSs, it may be necessary to install a different firmware.

For this, it is necessary to understand how you can detect the currently installed firmware and the required firmware:

The current firmware

You can see the current firmware by the logo in the top left corner:



Depending on the manufacturer, you will find the corresponding logo.

Checking firmware version

In the general system information, you will find this entry

Hardware	BACSKIT_B4
Firmware	CS141-SNMP V1.64.12 171213
Serial	1004211625 - 0030D6160377

The firmware version shows the OEM key:

- V1.64 - the current firmware
- .12 - the currently installed OEM version
- 171213- read the creation date backwards

If you want to operate the CS141 in a UPS of another manufacturer, you will find the necessary firmware on www.generex.de in the download area



CS141 Series Ethernet Adapter for the control and the management of UPS Facilities

Documentation
Connectivity
Tools
Firmware

Choose which CS141 firmware package to download

We make the CS141 firmware available for nearly all OEM UPS manufacturers.

- Release Notes
- Acknowledgements

Which OEM firmware would you like to download?

Generex (OEM 12)

You are about to download:

Generex (OEM 12)
Version: 2.06 220413

Download Now

Use the Show Version Info to check if an updated firmware is available for download. Please note that unlike updating within the same OEM firmware, changing the OEM firmware requires triggering a factory default setting since features and functions may vary among UPS manufacturers.

Most common problems while configuration and updating

This list contains typical errors that can occur when dealing with firmware updates:

Dip-switches / slide switch in wrong position

As a result, the CS141 uses either at the configuration mode IP address or an IP address assigned via DHCP. In this case you can no longer reach the CS141. Since the configuration mode on the hardware side has the 10.10.10.10 as a pre-set, it may also cause a network error, since this IP address will be used by any CS141 as a default.

Forgot manual IP address assignment or IP address set to factory default

The CS141 boots up and tries to get an IP address. If this is not possible, it starts with the default IP 10.10.10.10.

Forgotten Reboot

Since the CS141 offers the possibility to change the sliding switch on the fly and to carries out the function via software reboot, an update can evidently trigger the change of the IP address and the CS141 is no longer accessible. The reason for this is that the CS141 starts regularly with 10.10.10.10 and points the route to it on the local PC:

if you boot the CS141 the first time, set the sliding switch to manual mode, enter IP address data and then perform an update, only the IP settings you entered will be used. As a consequence, it seems CS141 cannot be accessed at the hardcoded IP address 10.10.10.10.

Web Browser caching caused issues

Modern web browsers use technologies designed to speed up content viewing and improving multimedia experiences:

- Speech recognition
- Auto-complete names and address data
- Automatic login into websites
- Personalized commercials
- Pre-caching files from websites
- Holding website files for faster revisit
- and many more ...

These media files are loaded into a separate browser cache to ensure the fastest and most comfortable possible web experience. The CS141 uses build-in web-based technology. If you use more than one CS141, web browsers sometimes show pre-cashed data:

Mixing identical content from different devices can cause strange or illogical error messages.

Note:

This is caused by web browsers' behavior. In this case, the browser cache must be deleted.

Force https is active

Depending on patch level and web browser used for displaying web-based content, some web browsers tend to detect this condition and automatically add the https. However, others ignore the wrong http query and return a device is not available message or react in a very strange way:

https was sometimes automatically enabled, but the https-query will be redirected to another device. In this case, browser logged your surf behavior and assumed that you meant another device that is known to use https. As a result, you enter the IP

address <http://192.168.3.15> and <https://192.168.3.56> will be shown. At <https://192.168.3.15>, however, it would have been the correct CS141 been displayed.

Again, the behavior of the web browser is involved to cause some confusion. Deleting the browser cache will fix it.

If nothing works...

The CS141 comes with two possible options if a problem needs to reinitialize the firmware or resetting the device to factory defaults.

If the CS141 does not allow a login or the interface shows a faulty display, but still can be reached regularly, administrators may try the following:

[http:// <IP address> / reboot](http://<IP address>/reboot)

This option allows you to force a restart of the CS141 directly.

[http:// <IP address> / update](http://<IP address>/update)

This option takes administrators directly to the update screen without the need for logging in

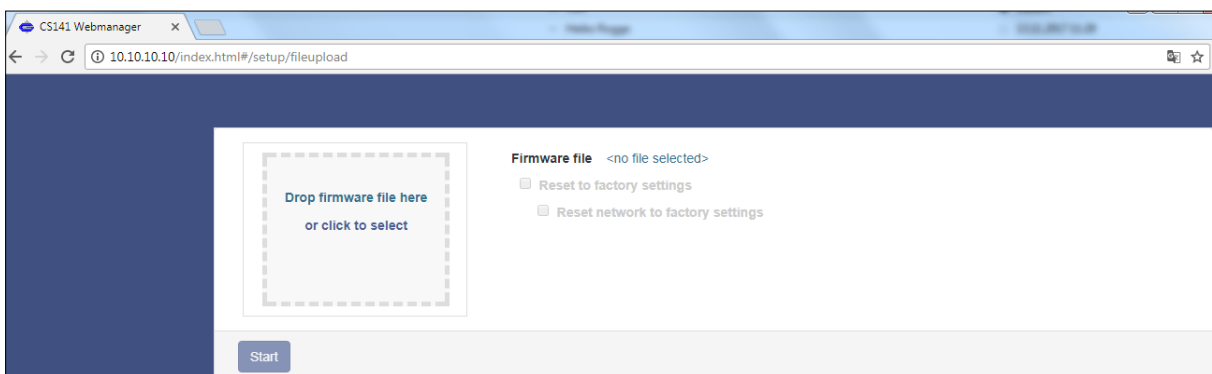

From now you can select the desired firmware package by drag & drop or by clicking the button. Please note, this function is a rescue system, the CS141 will reset all settings except the IP address. All configurations are deleted and the device is set to startup configuration.

Enter the password for the administrator account, if you are not in configuration mode.

The process starts and after successful flashing the standard login screen will be shown.

Note:

If you have lost the administrator password, move the DIP switch to center position. After cold boot, it is possible to flash the device directly. Enter the following line in your web browser:

<http://10.10.10.10/update>

As a consequence, the administrative password will be set to default setting.

Password lost / forgotten

For this feature, update your CS141/BACK to firmware 2.14 or higher
To use this function, physical access to the device on site is mandatory:

Put the sliding switch on the front to center position and restart the CS141 by pulling the card out of the slot (For the HW161, press the reset button to restart). For external devices, briefly cut main power. After the restart, the device is in configuration mode and can only be reached on IP 10.10.10.10 /24 (255.255.255.0)

Reconfigure your notebook to a counter IP (e.g. 10.10.10.12), connect directly to the CS141, open a web browser and enter the following:

[http\(s\)://10.10.10.10/resetPwd](http(s)://10.10.10.10/resetPwd)

The admin password will fall back to the default setting:

Nutzer: admin
Passwort: cs141-snmp

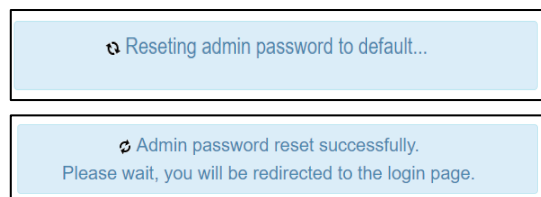

Starting the rescue system

If this feature is not available, the CS141 offers second option: During flashing, the CS141 saves a complete backup including the configuration of the "last known: good".

This version can be activated by setting the following jumper:

CS141:

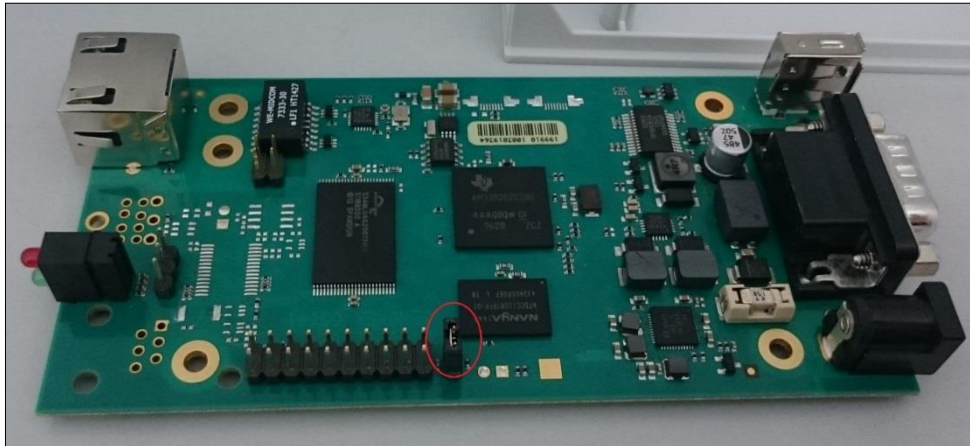

If the jumper is set and the adapter boots, CS141 will run this version as a rescue system based on the last firmware version: Inside the About menu, the firmware version will add the word RESCUE to show its current operational mode.

CS141 HW161



Rescue mode on CS141 mini*CS141 HW141 MINI:*

Due to its compact design, the CS141 Mini has no jumper that can be set. To activate the rescue mode, set both DIP switches to the ON position:

*CS141 HW161 MINI:*

Run a firmware update and reset the adapter to factory settings. Please note you are not flashing the operating system of the rescue mode:

You will not see the result until you return to normal operating mode and restart the CS141.

Note:

The CS141HW161 MINI / R2 has been fundamentally technically revised and, like all WEBMANAGERs of the CS141 product family, now offers the convenient rescue jumper: if your CS141 MINI provides a reset button and the slide switch on the front, use the rescue jumper for rescue mode.

PART II - BACS[®] Battery Analysys & Care System

Users manual

What is BACS®?

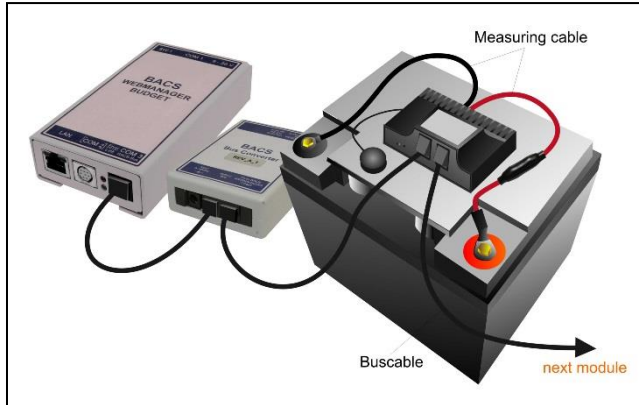

BACS® - the "Battery Analysis & Care System" - is the most advanced system on the market to manage stationary battery systems. It is a standalone battery monitoring and management system that can be easily integrated into your network infrastructure. With its intelligent web-technology configurable management technology, it cyclically checks the internal resistance, the temperature and the voltage of each individual battery. In addition, it can readjust the charge voltage of each battery and manage environmental readings (temperature, humidity, hydrogen gas content) as well as loads (UPS, inverters, and other devices). The accumulators are thus always kept in the optimal working range. The ongoing monitoring and limiting of the individual charging voltages of each block ensures the estimated maximum battery availability at any time. After installation, BACS® will

significantly find a way to increase and secure the performance at all lead-based, closed and sealed batteries (AGM, GEL, wet batteries, maintenance-free), nickel cadmium and lithium-based cells.

The BACS system was designed for the individual monitoring and to control each single accumulator inside a battery system. BACS regulates the voltage symmetry during charging and provides individual scalable notification options in case of an asymmetric discharge or similar faults:

- It stops the overcharging of individual batteries and warns in case of pending deep discharges.

The problem that weak accumulators may be damaged by unrecognized overcharging or deep discharging is now observed. Notifications in time allow counter measures before an incident occurs.

- The BACS unique system architecture provides active charge / Discharge control for each accumulator

The GENEREX BACS EQUALIZATION distributes evenly

the voltage from the charger / UPS is evenly distributed to all accumulators. As a result, a homogeneous voltage is present across all batteries inside the system. Due to this fact, average lifetime and capacity will be increased significantly.

- Sulfation problems are no longer a creeping threat

BACS EQUALIZATION minimizes the problems of sulfation through a constant trickle charge. In case the sulfation is in progress, BACS can detect this as a problem and ask for further assistance by the operator in good time. As a result, countermeasures like controlled discharging or removal of sulfation can be initiated before the accumulator is severely damaged.

- Real Time Capacity Test for all batteries

The Equalising / Balancing procedure provides BACS with all the necessary data to perform a qualified capacity test of each individual battery in a system. Once installed, BACS not only noticeably improves reliability and service life, a user also gets real time capacity information at the BACS monitoring screen.

A battery capacity test is normally well-known as a time intensive, costly and awkward method that requires beneath specially trained staff a lot of measuring hardware.

What is the advantage of BACS?

Manual monitoring and maintenance are expensive and complex - With BACS, they are no longer necessary Since the individual data of the accumulators are now available it is possible to maintain each accumulator individually at any time. If the BACS EQUALIZATION repair procedure does not work on one or more accumulators or irreparable defects are detected on a battery, it is possible to change one cell before the defect has a negative effect on the neighboring cells. The precautionary replacement of all batteries inside the system is therefore no longer necessary. By doing so, BACS ensures more than the availability of the battery system:

Its unique technology provides by the constant monitoring and managing of the batteries, the optimum capacity to ensure emergency operating time.

The data and experiences gained through our unique BACS since 2004 on the realistic behavior of battery systems shows how to double the average service life time of rechargeable batteries that are installed into UPS systems and why the UPS usage differs from a single rechargeable battery usage: The estimated life of a single accumulator is determined by the manufacturer - As an example, he states an estimated life time for a special battery model as 10 years. Since inside large UPS systems very many accumulators are interconnected, the single battery behavior will change according to the number of batteries in use:

The number of weak batteries with negative influences to neighbored ones will increase statistically.

Due to this fact, the overall behavior of all batteries leads into a significantly reduced time for active usage inside a UPS - the so-called service life. Astonishingly, this active service time is usually half of the stated battery life time. With BACS, it is possible to extend the life of any battery running inside a UPS to the manufacturer's stated battery lifetime. BACS offers more than best economical possibilities in single battery monitoring - it provides reliable data for extensive analysis and long-term studies.

BACS systems are available in 4 versions (2V, 4V, 6V and 12V) for a range of uses ranging from small 7 Ah batteries to large stationary lead-acid batteries up to 6000 Ah.

In addition, the BACS system has a state-of-the-art alarm threshold system that is continuously under development. BACS collects readings inside specially designed internal database for battery histories:

The device determines and stores individual battery values like internal resistance, temperature and voltage. With the optional BACS CSxxx current sensor, the scope of measured data will be enhanced with additional charge and discharge current measurements, valuable data for comprehensive long-term analysis. Collected sensor data will be sent directly via its own bus system to the central control unit, the BACS® WEBMANAGER.

All incoming information will be stored and processed:

After processing sensor data, the BACS® WEBMANAGER provides an intuitive well-structured interface to present the measurements. In companion to the data presentation and configurable notifications, additional alarm LED and alarm buzzer ensures that the UPS will be safe during operation. Finally, the BACS® WEBMANAGER has an intuitive user interface via web browser, which also contains a clearly arranged configuration menu.

EQUALIZATION: How to maintain individual charging / discharging of accumulators

As a continuously running background process, the BACS® WEBMANAGER calculates a so-called "charging voltage point" - A value each block should have at the instantaneous total voltage. If an accumulator deviates from this average charging voltage, the BACS WEBMANAGER sends a command to the corresponding BACS module that manages the accumulator. The BACS Module will manage to adjust the charging voltage to the calculated charging voltage point.

As mentioned, many different values are recorded and monitored - even the average activity and the number of charging and discharging cycles. If an event occurs during the monitoring which can be classified as serious or dangerous, the BACS WEBMANAGER can manage alarm notifications provided by direct network alarms as well as email, SMS, SNMP or RCCMD. If available, even an optional Modem can be used for customizable SMS alarming. In case of being operated inside a Modbus system, BACS Webmanager will also serve the MODBUS format via one of the serial interfaces and / or via MODBUS over IP

Additional Features

Thanks to optimised storage routines, the BACS WEBMANAGER provides a lot internal flash memory to record and store all battery data for up to 3 years (depending on the number of batteries and alarms). By using download options, all measuring data can be stored permanently: Alarms from the batteries or other devices connected to the UPS are logged with a timestamp - in order to ensure data and time allocation, the BACS® WEBMANAGER provides automatic time synchronization with free definable time servers as well as second clock inside the BACS BUS CONVERTER.



Picture: typical setup of a BACS

CS141 and BACS

To upgrade the CS141 into a full BACS system, you need the BACS Bus Converter



In case of your project involves larger installations with more than 50 batteries, we recommend the BACS Splitting Box. The Splitting Box allows to divide the installation into individual strings. A further application is the possibility to realize well-structured clear cabling of the BACS modules.

These devices can be ordered separately, among others, via the GENEREX web shop as well as comfortably worldwide via a certified GENEREX partner.

What is the difference between the BACS Webmanager Budget and the CS141 in companion with a BACS Bus Converter?

First of all: both devices fulfill exactly the same functions.

The difference is that the combination of a CS141 BACS and a Bus Converter is modularly composed of two separate devices, while the BACS Webmanager Budget consists of a complete device: While the single device has a more compact design, the modular solution allows to separate the BACS BUS Converter: Take it along while the CS141 will continue in place its monitoring and managing works. In both cases, it is possible to connect a computer and use the BACS tools.

BACS WEBMANAGER Kits



The BACS WEBMANAGER BUDGET is the central control unit for all batteries connected to the BACS bus. The BACS WEBMANAGER KIT contains a BACS WEBMANAGER, a BACS CONVERTER, all necessary cables as well as power supply.

The BACS WEBMANAGER can be configured via a special BACS data cable as well as via a network interface.

Each BACS WEBMANAGER system includes a full-featured SNMP / Web UPS Manager on COM 1 and offers a variety of sensors for access control, temperature and humidity as well as versatile environmental sensors. Even customer-specific sensors can be used via the optional SENSORMANAGER.

Upgrade your CS141 into a full-featured BACS Webmanager:

For this configuration step, navigate to the following menu:



General COM port settings

Under Devices, click on the menu Setup. This will allow to activate the BACS capability and is necessary for further configuration. Without this setting, the BACS menu is not accessible.

Note:

An easy method to figure out if your CS141 model can be used as a BACS Webmanager:

As soon as your CS141 provides an AUX-Port, your CS141 will support a BACS BUS Converter in general. You just need to look at the ports. If you cannot access the device physically, you can take a look at the General COM Port settings. If your CS141 model does not provide an AUX port, COM3 is not available.

BACS can be operated a completely standalone system - independently of your previous UPS configuration. Even it is useful for BACS to know the current UPS state, it is not required. If you just want to monitor the batteries in standalone mode, you can disable the UPS functionality by setting COM 1 from UPS to none.

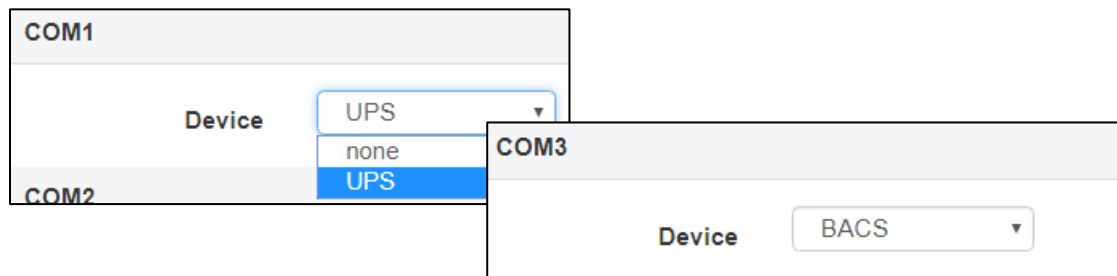

If you want to monitor the alarm behavior of the UPS and already manage your network, let COM 1 be on UPS - BACS will be operated like an additional feature. These basic settings are mandatory to be set for both - slot card versions and the external versions of the CS141.

Note:

The UPS with their connected batteries generally stay together!
You can not monitor a UPS and connect the BACS-monitored batteries to another UPS. The power source is not important for CS141 as long as the correct UPS is queried:

it is crucial that the charge / discharge detection is configured to UPS as well as the associated batteries.

Since the BACS Webmanager provides different possibilities to query a UPS it is possibly it is up to you to select the best power source as well as to configure the correct target. You can not use one BACS Webmanager for different Battery sites.

When saving, necessary services are started. After finishing this process, a new BACS menus will be accessible:

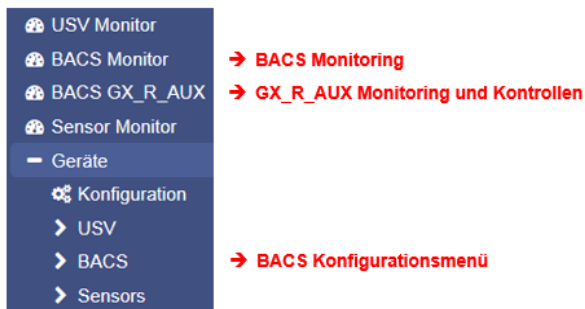

Hardware precondition: Connecting the BACS Bus Converter to the CS141

Even the menus are accessible, the BACS Bus Converter needs to be connected to CS141 before starting configuration. Use the AUX-Port of the CS141 and the COM 3 Port of the BACS Bus converter to establish a connection between the devices:



From the CS141 AUX-Port

... to the COM 3 port of the BACS-Bus Converter

Since the cables are coded, a wiring failure should not be possible. During installing, ensure neither to jam the connectors nor to use brute force - the contacts may be damaged.

Once communication has been established between the devices, a relay will click inside the BACS Bus Converter and a red LED will light up on top, followed by a buzzer.

Press Mute to temporarily switch off the alarm. You can not switch off the alarm permanently, after some time it will be automatically fall back to active state.

In addition, the upper status bar inside the CS141 web interface will show a "Communication Lost" issue - This status is normal in this configuration state since there are no modules installed or something is configured.

Using the BACS capabilities of a CS141 SC slot card



Connect the AUX-Port of the CS141 SC with COM 3 of the BACS Bus Converter. At CS141 SC, configure the COM-Ports as described. You do not need to restart the CS141 SC.

Note

If the menu does not appear even though you have switched COM3 to BACS, your web browser may use old files stored at an internal browser cache. Modern web browsers use caching technologies to increase the display speed of web-based content: As an example they store alleged static contents for further usage or may pre-cache complete webside contents before displaying them. In this case, it may lead into presentation failures like missing links or even wrong menus if they has been moved by a firmware update.

Please clear the browser cache and press CTRL + F5 to refresh the display and the menu should appear.

Now let us talk about your brand-new, worldwide unique BACS® - the "Battery Analysis & Care System":



This graphic illustrates a full-featured and fully equipped BACS system. Due to the fact BACS is scalable it can grow with your UPS and even easily ported to a new system – if you decide to purchase a new UPS, you can take all the modules from your old BACS – equipped UPS and install it on your new batteries.

After a quick reconfiguration, BACS will automatically start to learn how your batteries work and what they really need for best performance.

How to read and use the BACS manual

BACS is designed as a stand-alone system

Since BACS is a complete stand-alone system, it can operate on its own, too. You do not need to read the complete CS141 manual, but it will help you to understand how the menu structure works and all about the icons used. If you want to use a UPS and the RCCMD environment, we recommend to start with the CS141 configuration guide and then moving on to your BACS installation.

If you have worked with the CS141 before

If you are familiar with the menus of the CS141 and know how to add a job as well as how to set up mails, mailtraps, etc. ... well, you do not really need the first part of the manual and will be able to understand and configure the BACS system quickly:

- Events
- Jobs
- Mail / Mailtraps
- Discharge detection

The BACS web interface is designed to provide a fast way to configure it intuitively. And like the CS141 part inside this manual – this manual is written to explain.

BACS Module installation guide**DANGER:**

Please keep in mind that batteries, battery racks and current-carrying equipment may be under high voltage - there is a real danger to life when touching high-voltage components! Working with batteries need your total attentions and following the rules. „Short cuts“ are just a method to figure out if you can survive your mortal incident...



In the case of non-expert or appropriate handling, there is an acute danger to life when handling modern battery systems. There are also numerous legal requirements that personnel must meet during installation, operation and maintenance of electrical systems. For this reason, we ask you to read the following safety instructions carefully and consult in case of doubt experts or at least specially trained professionals:

Fundamentals when working on battery systems

Make sure that the environmental conditions for installing BACS is met.

An incorrect handling can lead to personal and material damage! GENEREX is not responsible or liable for any direct or indirect damage caused by incorrect handling.

Risk of explosion and fire

Avoid short circuits! Caution: Metal parts of a battery are always charged, so never put metal objects or metal tools on the battery!

Elektrolyte are extremely corrosive liquids.

Leaking electrolytes in a battery are harmful to the health of the eyes and the skin. Heat fumes can be easily inhaled and cause severe damage to the lungs.

Ask trained and qualified personnel only

Working with batteries installed inside high voltage areas are dangerous and always need special attention. Especially installation and maintenance procedures should only be performed by these trained personnel or by personnel authorized by the battery manufacturer - the personnel must be familiar with the handling of batteries as well as necessary precautionary measurements.

Non-expert staff can run into situations with acute danger to their life due to high voltage!

Follow the legal regulations carefully

- ZVEI publication "Instructions for the Safe Handling of Electrolyte for Lead-acid Accumulators."
- ZVEI publication "Safety Data Sheet on Accumulator Acid (Diluted Sulphuric Acid)."
- VDE 0510 Part 2: 2001-12, in accordance with EN 50272-2:2001: "Safety Requirements for Secondary Batteries and Battery Installations - Part 2: Stationary Batteries".
- IEEE Standard 450-2002: "Recommended Practice for Maintenance, Testing and Replacement of Vented Lead Acid Batteries for Stationary Application."
- IEEE Standard 1375-1998: "Guide for Protection of Stationary Battery Systems"

Note

The legal requirements may vary depending on country and state. Furthermore, the current legal requirements may be adapted or even changed completely by local regimes over time to include new technologies and scientific findings or as a direct reaction of incidents dealing with a special technology:

If in doubt, contact the local authorities before determining any safety precautions for the installation or operation of a system.

Obey the safety rules when handling electrical conductors and components

- Ensure that all electrical loads and power supplies (chargers) are switched off as well as required fuses and switches are secured before starting maintenance work. This must be done by qualified or specially trained /certified staff.
- Remove all wristwatches, rings, chains, and other metal objects before and working on batteries until work is done and you enter secure marked area.
- Use insulated tools that are certified for the work.
- Wear insulated rubber gloves as well as rubber shoes
- Never place tools or metallic components on the batteries.

- Make sure that the batteries are not accidentally grounded. If the system is grounded, release the connection: Touching grounded batteries may lead to an electric shock accident.
- Check the correct polarity before wiring a battery. Wrong polarity will lead into damaging including the possibility fire, explosion, corrosive hot gas
- Stuffed lead acid batteries contain high explosive gas (hydrogen / air mixture). Never smoke and or provoke sparks near the batteries. Avoid electrostatic discharges - wear cotton clothing and, if necessary or required by local law, ground yourself before maintenance work.
- Always wear the appropriate clothing and take care they are suited to statutory safety and protective arrangements.

Avoid areas that are not suited for battery installations

Standard modules shall not be used in case of ...

- outdoor or open space usage as well as non-water protected, enclosed spaces.
- dusty rooms or places with high levels of dust.
- in areas of high concentration of saline as well as oxidizing gases.
- the place is next to open fire, spark zones, heat sources or inside heat extreme zones.
- areas that are known for high temperature fluctuations that cannot be normalized by environmental control systems.
- areas that are known for with high vibration or mechanical movements
- areas that are known for gas concentration or other flammable substances

Note

In some cases, there is a small and fluently defined borderline that decides about a location is appropriate or inappropriate for installing and operating a BACS system. If in doubt, please contact the GENEREX Support Team, we are happy to advise you about the possibilities as well as environmental conditions to be met. Just write a small mail to our support team: BACS@generex.de.

if you need to install BACS and the area is known to deviate from a standard installation for technical or environmental reasons:

GENEREX offers especially insulated and sealed modules to handle these installation scenarios.

To be noted during installing a BACS

1. *High voltage danger*

Do not open the BACS sensor; Do not attach objects to the battery or to the BACS modules! The BACS modules and cables could be under high voltage!

2. *Magnetic fields*

Keep in mind that every live wire creates a magnetic field around it. The strength of the magnetic field depends on the current: a large If insufficient shielded, a UPS system can generate very high electromagnetic interference (EMI). Therefore, avoid the installation or operation of technical equipment that is susceptible to electromagnetic fields.

Take care for technical staff using a cardiac pacemaker - Magnetic interferences may harm regular functions and even destroy these vital devices!

3. *Trained and BACS qualified technical staff only!*

BACS is installed on batteries that can be under high voltage during installation. As soon as the BACS measuring and connecting cables are connected to the batteries, they may be under high voltage, too. To prevent short circuits, ensure the system is disconnected before performing any maintenance or installation work in companion with BACS cables. Since a certain order must be adhered to, special trained and certified BACS technicians are required.

Note

Need a BACS training for your technical staff? Speak to us – our BACS training team will be pleased to advise you the best way to get a BACS certification training.

4. *Replace damaged batteries before installing BACS for the first time*

Damaged are batteries often not determinable by a mere visual inspection. A damage can be found during a measuring the internal resistance - the higher the internal resistance, the worse the current condition of the battery.

The problem:

If a battery is highly damaged that the internal resistance exceeds maximum possible highness, the charge / discharge current will no longer be able to pass through the battery. Because the charge/discharge current must find a way it would seek the path of least resistance: The BACS module. As a consequence, unplanned heat will be generated that can damage or destroy the BACS module over time. Due to this fact, do not continue and use batteries in a battery bank that are already detected externally as defective or if the BACS module measures a very high internal resistance!!

5. *Never mix different BACS module versions as well as BACS types of measurement cables.*

BACS modules differ technically within the revisions. The according measuring cables were specially adapted to the corresponding revision of the BACS module. If you mix different BACS modules, it will not work in general. In addition, an unfortunate combination of different modules may lead into irreversible damages to the cables and BACS modules. Before starting to install cables and modules, ensure that you do not have mixed your stock for installation:

Sort modules and measuring cables beforehand.

Rework, maintenance and care

Regularly check the measured values of the modules and the temperature development of the batteries

- ... during installation and during the first charge / discharge cycle

During its initialization, BACS performs its own diagnostic measurements to find hidden defects that may occur within combination of used and new batteries. Until BACS has fully captured the batteries in order to provide a reliably report defective batteries:

As soon as unusual temperature fluctuations and unusual increases are noticed, the according battery should be replaced immediately.

- ... up to 12 hours after complete discharge until depleted

Followed by a regular discharge from a power outage, the most common "thermal runaways" occur - a massive increase in temperature on damaged batteries that can become so hot that leads into acute fire hazard. Statistically there is the highest risk of battery failure with damage to the electrolyte within the battery can be found significantly inside a time window of 0 to 12 hours after discharge. If the temperature of the battery continues to increase after a discharge instead of staying the same or slowly decreasing, the charging cycle should be stopped immediately and the affected battery replaced. On passing this time window, a battery pack can be regarded as stable - it can be reintegrated into the normal chain of alarm states.

The warnings and issues BACS provides should be taken seriously - Respond in good time!

BACS was designed and developed to extend the service life of accumulators in multiples. BACS will not only inform you with cyclically status messages that something was wrong after deviated behavior is detected at the monitored systems. Thanks to the unique control technology combined with efficient early warning and alarm functions, BACS will inform you before an incident can harm your system:

You can react before a real incident occurs that may damage your entire system.

Please keep in mind that the protected technologies behind BACS will cushion battery or charge control errors over a period of time from the first warning, but will not be able to permanently compensate for real defects.

Additional components required to assemble a BACS:*BACS Battery C-Module*

The control of the charging and discharging processes of each accumulator during the EQUALIZATION procedure as well as the measurement of the actual battery state are carried out by so-called BACS® battery C-modules. These modules are mounted on each individual accumulator. The according C module to be used in your battery system depends on the battery used and must be dimensioned accordingly.

The key figures of the available C modules are documented in the current BACS data sheets

BACS measuring cable

This cable is used to measure the voltage and impedance of the connected battery. It is a 4-pin cable with 2 fuses in the positive cable (red) to protect the BACS system against high currents or short circuits. When installing, the connection order is important: This cable must be firmly connected to the battery poles BEFORE connecting the BACS modules:

With wrong handling, the integrated fuse is sensitive and may trigger.

BACS bus cable

The BACS bus allows high-speed communication between all BACS modules within a battery system. This cable is specially designed for use with BACS only. It is shielded and calibrated against EMI to ensure communication even in harsh environments.

Before you start ...

like the CS141, when using BACS there are many things that should be considered before starting an installation - there are many individual installation options to be used. One of the most important thoughts coming with this context, is whether and how to extend the technical possibilities of existing systems. One of the biggest problems here is that completely different systems may have to be coordinated with one another in order to work together towards the same goal.

fact, the BACS system makes it easy to be added:

It does not care whose batteries should be managed unless different UPSs are combined to charge the batteries - this should be avoided, because a BACS Web Manager will expect one UPS for the connected batteries is responsible. Otherwise the measurements are strange and not suitable analyses. However, as long as this framework condition is met, it would be a quite useful information if the UPS could communicate its own operating state, but it is not needed.

Due to this fact, a BACS system can be fitted seamlessly into almost any infrastructure in order to manage the batteries *The*

Central task of BACS inside an existing infrastructure

In addition to the monitoring of the battery conditions, the central task is care and active regulation of the batteries during the complete charging / discharging cycle. Thereby BACS takes into account the needs of each individual battery in relation to the overall system in order to ensure improved lifetime as well as maximum performance if an emergency situation occurs.

For the operation of BACS, it is not important to know UPS that will charge the batteries or which discharge circuit will be used - as a standalone system, BACS can detect the basic system states with its own sensors inside each BACS module:

- charge status
- discharge
- trickle charging status

The following installation examples may give you an insight overview about installation possibilities:

Installation example 1: BACS as a standalone system

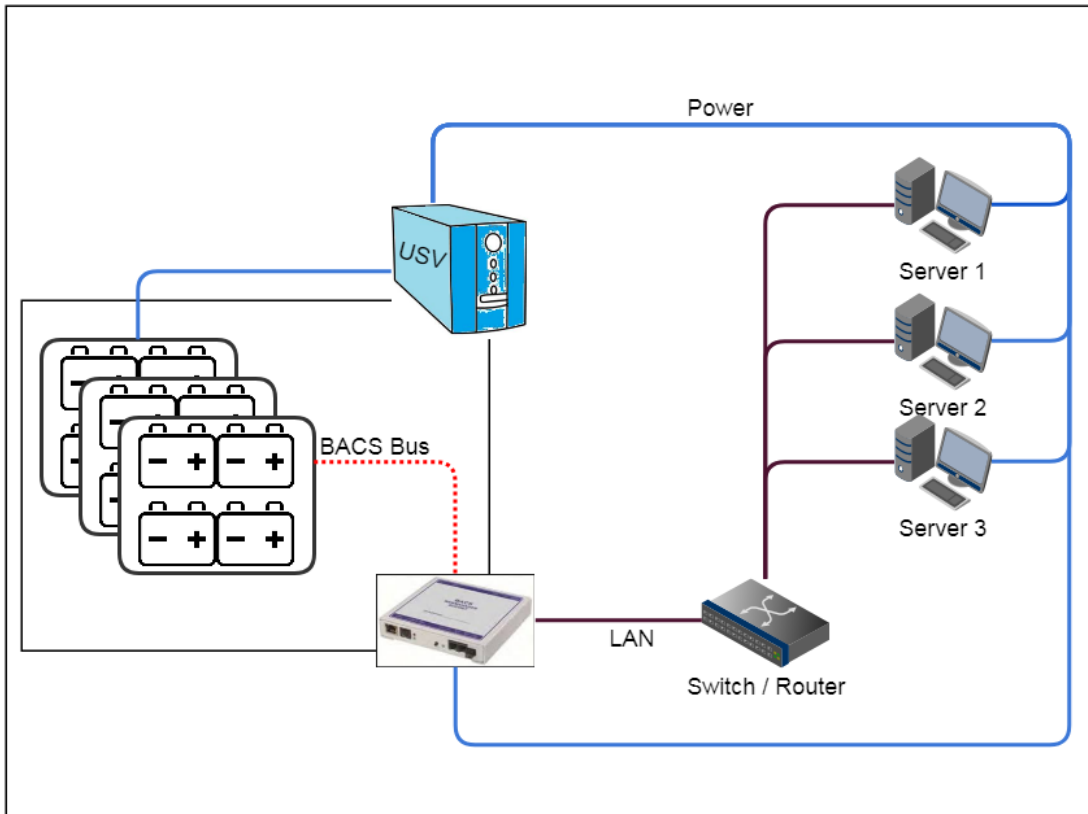

BACS is not able to get system states from the UPS and is limited to the core task of monitoring connected batteries and regulating charging cycles. The sensors of the BACS modules, which are individually connected to each battery, can detect charging / discharging cycles and provide the necessary data for the control to the BACS. If individual batteries with deviations become noticeable, the BACS Web Manager can automatically inform about this battery condition before a dangerous incident occurs.

The disadvantage is that the general UPS functions and system status are not available:

BACS can detect that the batteries are discharging but fails to inform about the reason, why this happens.

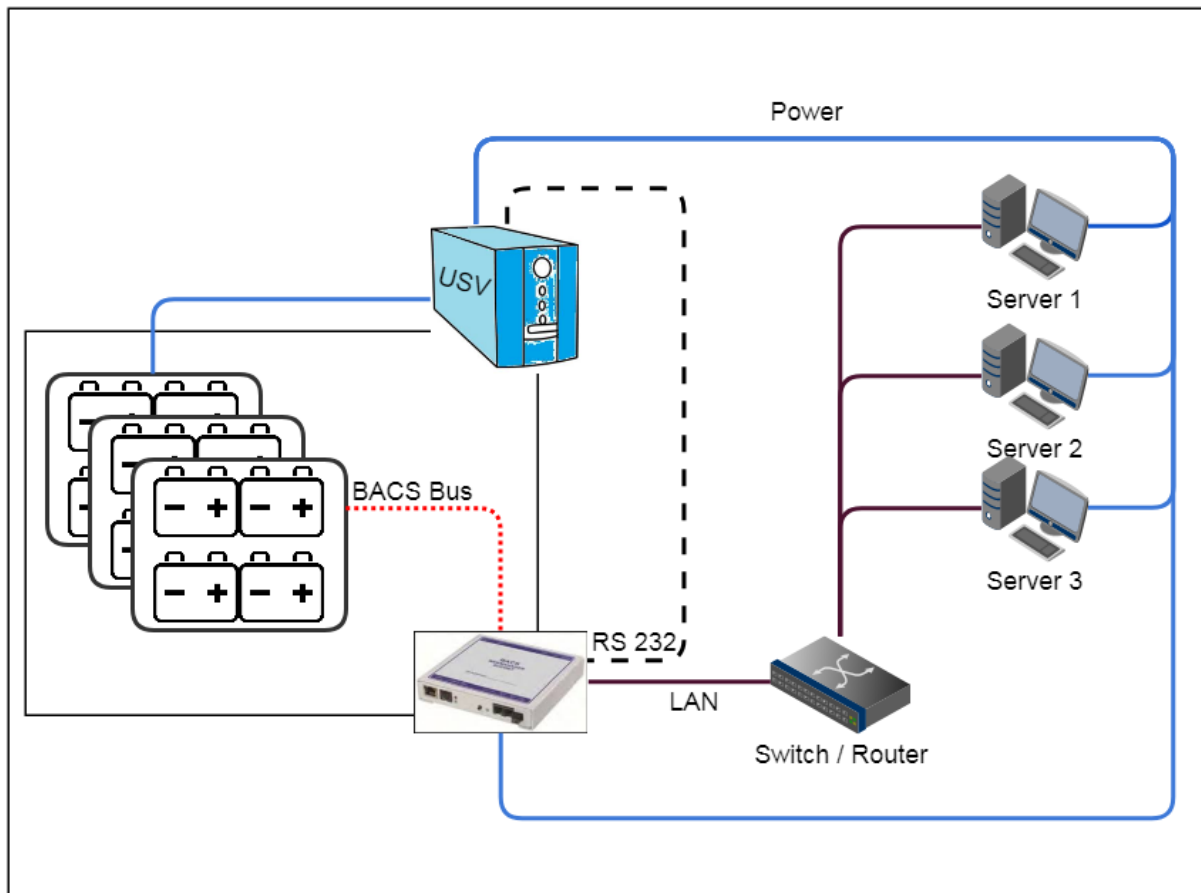
Installation example 2 – the complete solution: BACS is connected to the UPS via RS232

The BACS Webmanager budget is connected to the UPS via the RS232 interface. The BACS modules are supervised by the BACS Webmanager budget. With this solution all options of BACS and the CS141 are available:

- Extended UPS management
- Freely configurable emergency behavior
- Connection of external sensors
- Emergency server shutdown management
- External Input / Output management

While the UPS monitoring is fully featured, the BACS Wemanager can handle complex jobs according to system events to protect the entire IT infrastructure, the integrated BACS system protects the batteries from dangerous charging currents to ensure a reliable and solid emergency power supply.

The BACS Webmanager budget is an all-in-one solution for your entire network.

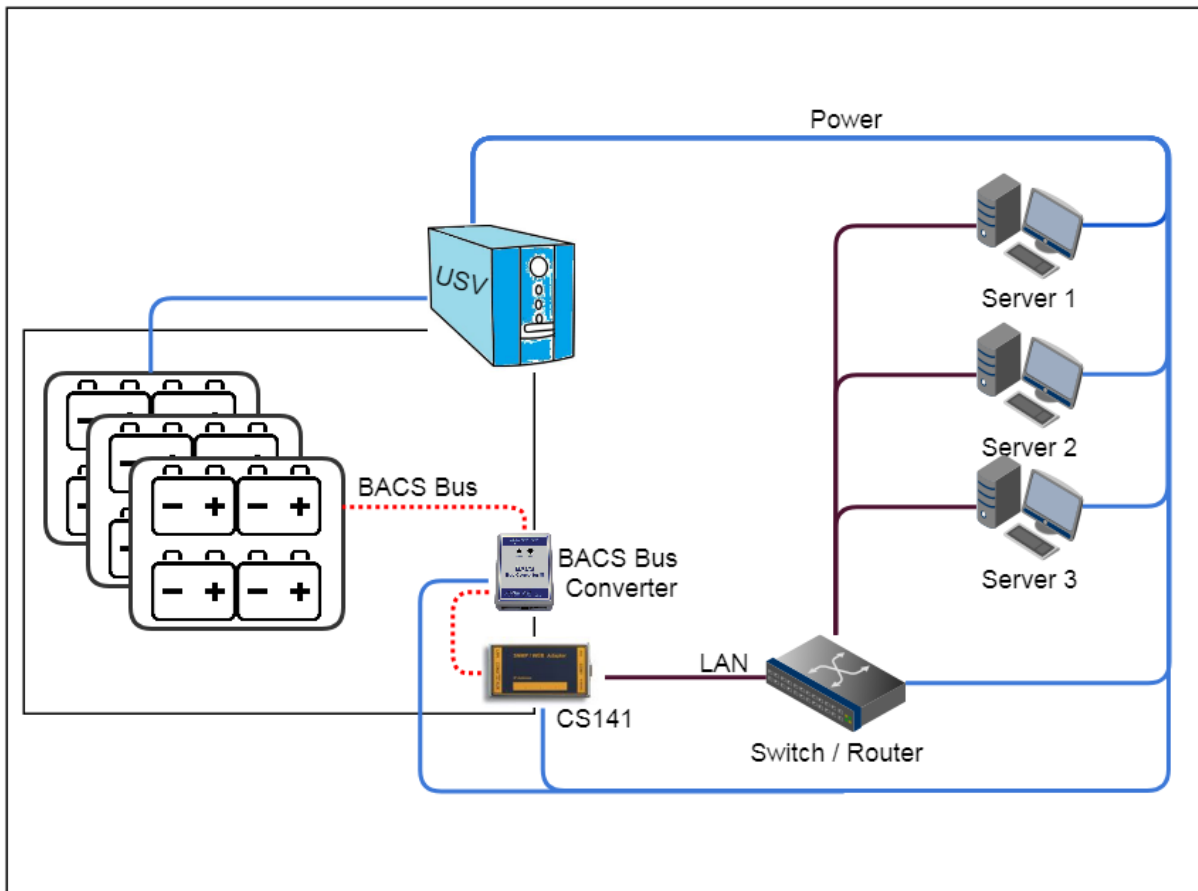
Installation example 3: A modular solution that grows with your IT infrastructure

The modular BACS solution provides more than just installable in case of realigning by installing a new UPS controlled emergency power solution. The modular version can be installed as a UPS manager, and then grows with the tasks even to a fully featured BACS system that always fits to your UPS. As the modular installation example shows, a BACS bus converter is set between the BACS modules and the CS141 and activate the according COM Port inside the CS141. The CS141 will start the BACS capability and provide all menus of a full-fledged BACS System.

The BACS Bus Converter is needed to establish a communication between CS141 and BACS modules. The peculiarity here is that you can "reuse" already purchased parts, which minimizes the acquisition costs for a full-fledged BACS system.

The existing UPS configuration with the alarm behavior will be enhanced by battery monitoring and management capabilities.

It is up to you to decide ...

If you prefer the the CS141 as a slot card or as an external box - once the CS141 provides the AUX interface, it can be upgraded to a BACS system.

With BACS, you can plan your emergency power solution and adapt it to future trends as required.

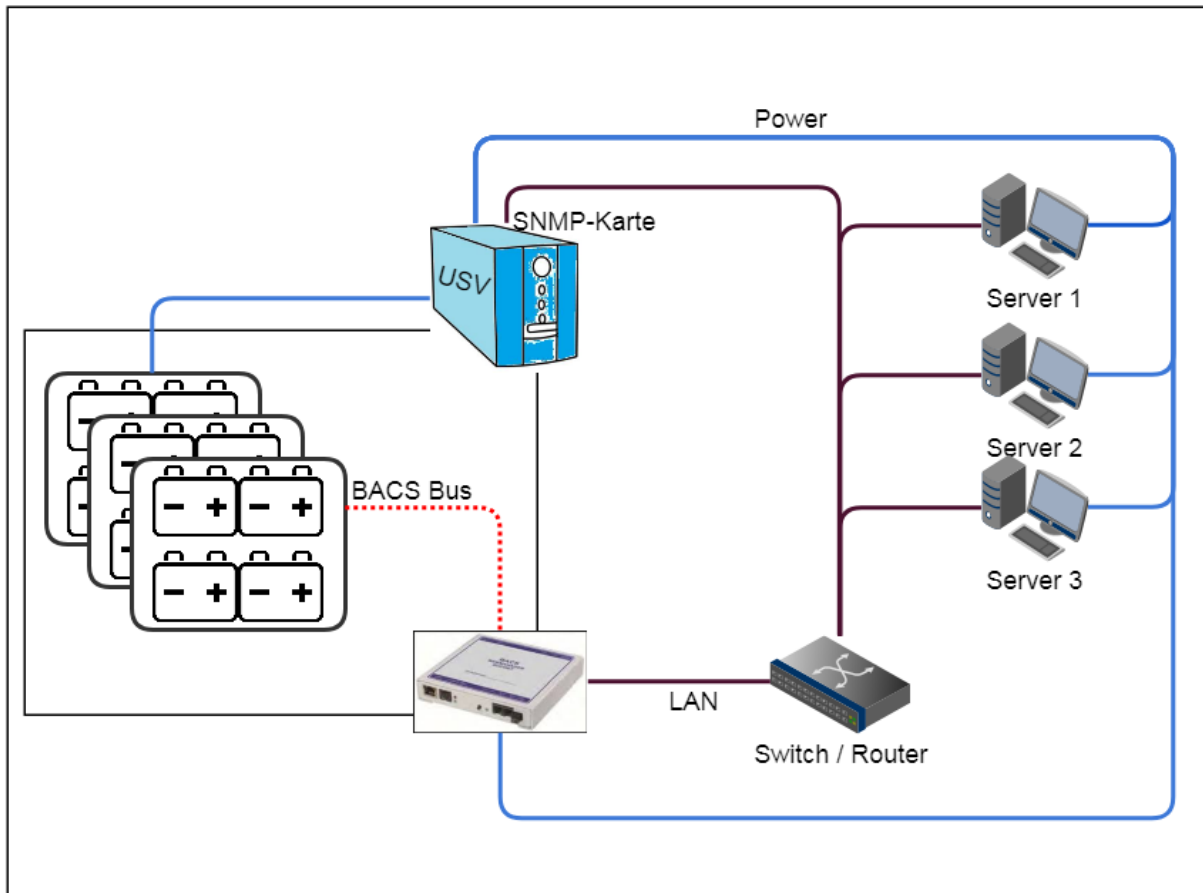
Installation example 4: The LAN SNMP solution – if you need UPS information without a direct connection

If you have read the CS141 manual, you will notice this feature at the latest at this point:

Unfortunately, some UPS models are not compatible with the CS141. Causes are, for example, that the interfaces do not exist or are otherwise occupied, existing slots of the UPS have a different design or simply the manufacturer wants to use their own system cards. If your UPS uses its own SNMP card or a similar solution, you can use the UPS settings in the BACS Web Manager to query the signals via SNMP and manage all UPS functions based on this data - each CS141-based model provides this feature.

Since BACS can use this UPS information as "Discharge Detection", this data is not only interesting for general monitoring, but also a reliable means to detect the current UPS state:

All you need to do is:

- Open UPS configuration dialog
- Select RFC 1628 smart interface as UPS model
- Enter IP address of the target SNMP card
- Enter SNMP v1 / 2 / 3 credentials
- Configure an according SNMP user at the target card.

The SNMP card will be queried by the CS141 / BACS Webmanager budget and presented at the UPS monitoring screen.

Note

Yes, this feature can be used with the predecessor CS121 or an existing CS141 that is already installed but does not provide an AUX port, too – if the BACS Webmanager cannot be fitted directly to the UPS, you may use this powerful feature to adapt the BACS Webmanager fitting to your existing UPS solution.

The BACS Bus topology

As well-known from network technology, there are always different ways to connect nodes and devices with each other. You need to choose the best solution for the according task and take care not to connect all nodes in a way to set up a network short circuit...

When connecting BACS modules, there less things to be obeyed - the wiring of the BACS modules follows two simple rules:

Rule 1: Each ID can only be assigned once

One single Strain:

On delivery, BACS module and BACS sensors use the basic ID 0. When the BACS Web Manager calls the address 0, all modules are addressed. During initialization via BACS Programmer, the individual BACS modules receive a single unique ID. This ID is once inside this BACS installation. The module installation order does not follow the according row of address ID's: After initialization, the BACS Web Manager queries individual addresses and the addressed module will respond accordingly.

Two or more strains:

Inside the strain, the ID's hast o be sorted by a specific order. Between different strains, the pool of numbers must be sorted:

Strain 1: Module-ID 1 – 10
Strain 2: Module-ID 11 – 20
Strain 3: Module-ID 21 – 30

Never mix ID module pools between strains!

Rule 2: Obeye the maximum cable length

The better the signal, the more stable the entire BACS system will finally work

Rule 3: Obeye magnetic interferences

Any live wire produces a magnetic field that affects other metallic objects and conductors. Although the BACS cables are specially shielded against magnetic influences, the installation site can strongly take effect to the quality of the data signal. If you have a lot of interference, test for these magnetic interferences.

Connection examples

in general, BACS does not tell you how to connect all modules each other - a structured wiring method will help you to do maintenance work as well as finding problems during installation. Furthermore, well-structured connection methods will help to improve reliability when operated. Due to this fact, there are some hints you should need to before wiring. Both, the BACS Bus Converter as well as the BACS Webmanager Budget provide two ports for a BACS bus. The possibility to select the appropriate installation type allows different setup scenarios

1. The classic ring topology:

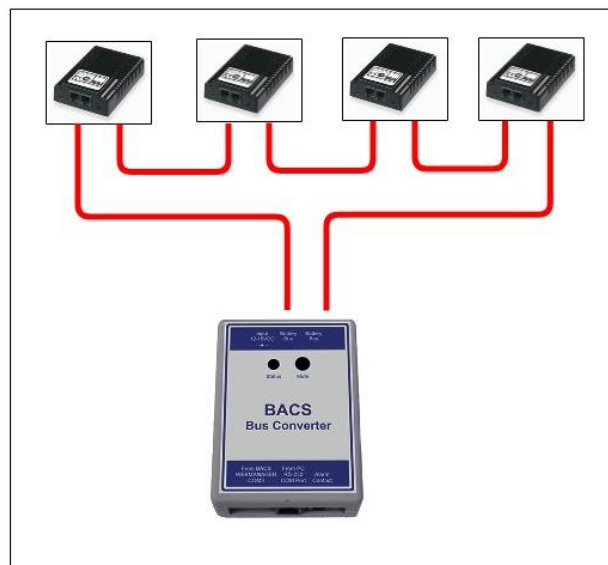

The advantage in the ring topology is the extremely high reliability. The BACS modules can be reached by the manager via two different directions. Should one cable fail, there is a second redundant connection that can compensate for this.

Note:*Special feature of ring structures in connection with changing magnetic fields and electromagnetically interfacing pulses*

In this manual, you will often be informed about the advantages of a ring structure. Generally speaking, the advantages are obvious, because with a ring structure, each module always has two uplinks to the BACS Web Manager and can therefore be reached redundantly.

But as always, there is a disadvantage, too: Electromagnetic Interference (EMI):

In this case, this topology can prove to be counterproductive, because a ring in particular, despite all shielding, is simply a very good antenna for the reception of electromagnetic waves. Due to the nature of a ring topology, electromagnetic pulses may create sporadic interference pulses within the BACS Bus cables that may build up over time until the pulses interfere with the BACS Bus data signal. Unfortunately, it is difficult to predict when this will happen, as there are many spatial, natural and technical influences (usage behavior, position of the cables, interference pulses from the chargers but also consumers or even natural influences such as rock formations in underground vaults, ...).

If you encounter such problems, it is recommended to drop the ring topology and use simple bus cabling instead.

2. The classic star cabling:

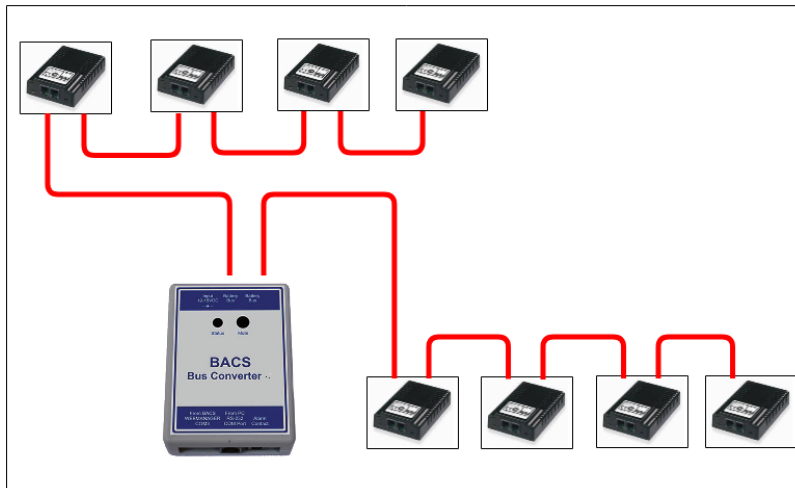

With this topology, the bus cabling runs in different directions from a central point. Its advantage is the more flexible design of the wiring and the resulting usability of premises.

Since you are not bound by certain conventions, the batteries can be arranged flexibly and adapted to the environment:

Each single strain may use the maximum available length.

Due to the fact, a star uses a single line connection type, a cable problem will lead into connection lost alerts.

The Splitting Box

A good tool for a well-structured cabling is the separate available BACS splitting box. This box allows splitting a cabling strain into different smaller strains to realize well-structured cabling and to avoid loss of signal due to the longer cable increasing resistance:

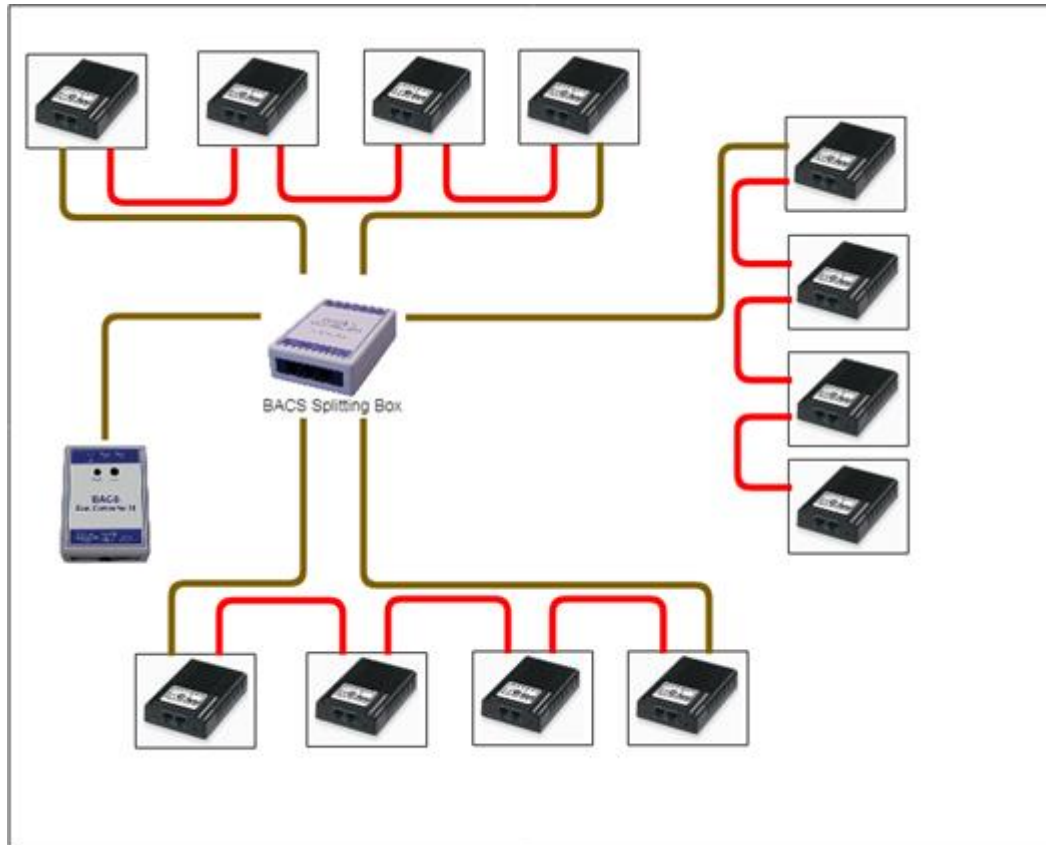

Each box provides six ports and allow several configuration methods. In this example there is a ring-topology with 3 strains – but finally it is up to you how to set up the wiring:

- Ring topology
- Star cabling – connect up to 7 single strains
- Both of them – two ports for a ring two ports for the BACS webmanager, 4 ports for single strain
- Mixed up – Port 1 of the BACS webmanager for starting a ring, one port for the BACS Splitting box, at splitting box 6 Ports for single strains and one port to close the ring from the BACS webmanager, ...

Only the use of one single splitting box will enhance you options to connect BACS bus cables.

How to use more than one BACS Splitting Box (and the reality of electromagnetic interferences)

The BACS splitting box is a flexible device. With this device, it is possible to:

- Create partial redundancies
- Create partial ring cabling
- Create ring cabling with different splitting boxes

This flexibility allows technicians to be structured as well as flexible about the locations and technicalities of a BACS installation to maximize reliability:

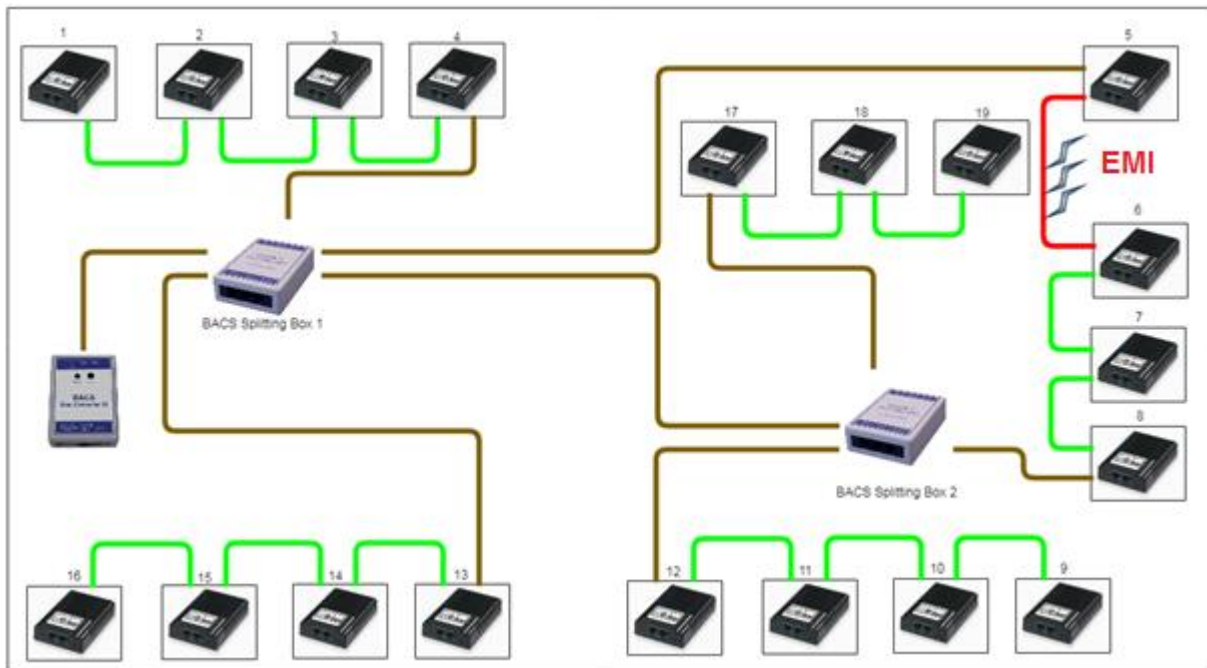

Example: The diagram shows a combined BACS Bus wiring

The drawing represents a wiring plan, oriented to fit to spatial local possibilities. On a close look, the diagram comes with both, a simple bus wiring and a ring topology:

The ring starts at the BACS Splitting Box 1 and goes to first from BACS Module No. 5. From there, the ring wiring proceeds its way via module 6 7 and 8 to the Splitting Box 2, which in turn is directly connected to the Splitting Box 1. By following the wiring, a small ring is formed up.

Why someone chosed the central ring within the BACS Bus:

Even in case of a broken data cable between the direct connection of Splitting Box 1 and 2, the BACS bus shall continue to run via Module 8.

Practice, however, put a spanner in how the idea works:

Since the ring topology acts like a perfect antenna, EMI - electro magnetic interference radiation -from a UPS or any high voltage lines may be accidentally received and therefore form up interferences on the BACS bus over time. Finally, the ring topology will lead into a sporadic disturbed BACS bus. In this scenario, the BACS bus cable between module 5 and 6 must be removed to eliminate the interference, because a ring line would be counterproductive.

Note:

The BACS Webmanager is the central monitoring and management device. The BACS bus is designed to ultimately avoid network short circuits and to provide any number of redundancies. Nevertheless, structured cabling is recommended to ensure the transparent traceability of an installation

Technical data of the BACS Splitting Box

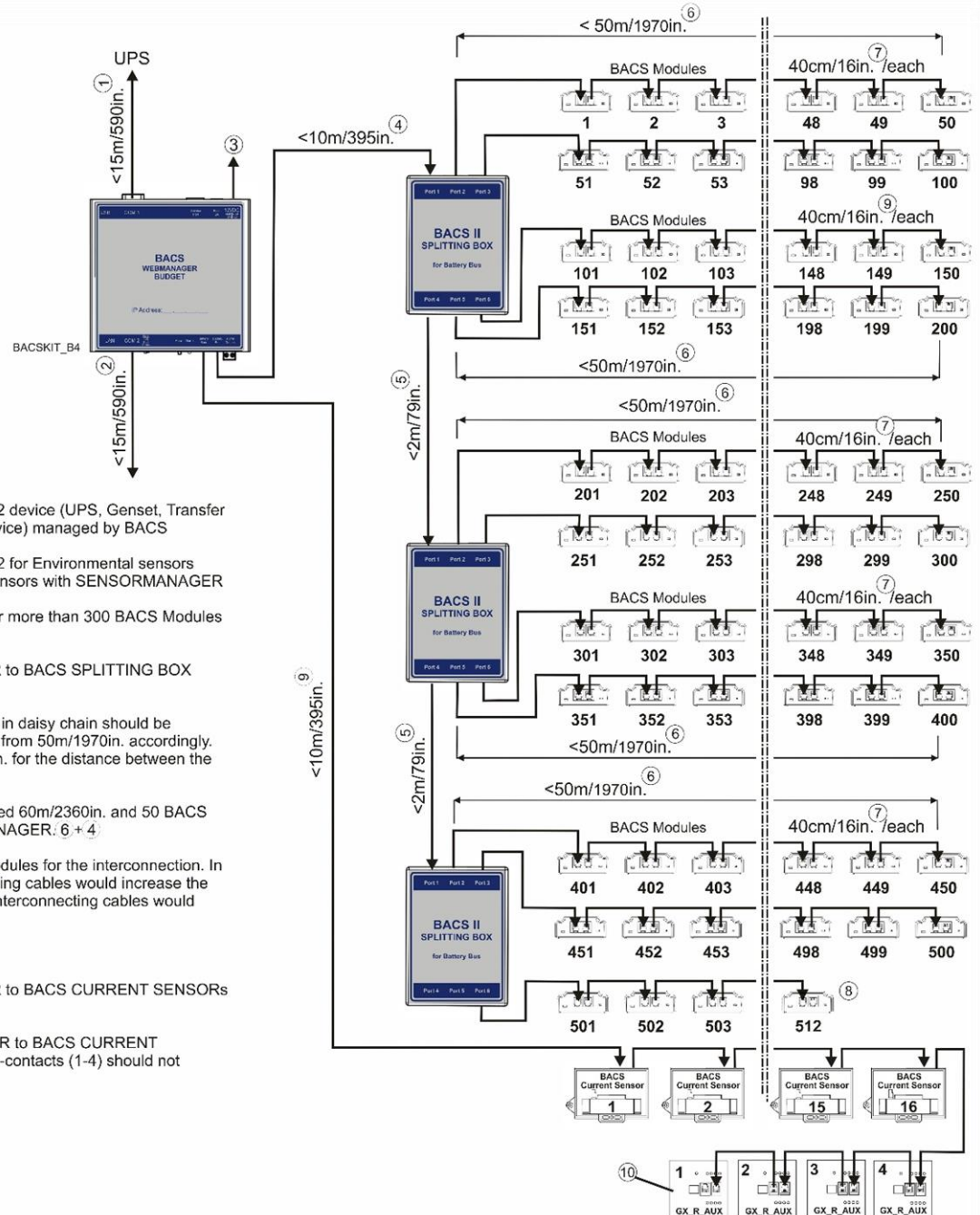

1. Max. distance 15m/590in. to COM 1 RS232 device (UPS, Genset, Transfer Switch, Charger or other battery-powered device) managed by BACS
2. Max. distance 15m/590in. to COM 2 RS232 for Environmental sensors (SM_T_COM, SM_TH_COM) or 3rd Party Sensors with SENSORMANAGER
3. Power Supply 12V/2A (UPS protected). For more than 300 BACS Modules a 3A Power Supply is required
4. Max. distance from BACS WEBMANAGER to BACS SPLITTING BOX should not exceed 10m/395in.
5. Distance between BACS SPLITTING BOX in daisy chain should be <math>< 2m/79in.</math> – or shorten the total length of bus from 50m/1970in. accordingly. (Eg. reduce to 40m/1575in. to gain 10m/395in. for the distance between the 2nd BACS SPLITTING BOX)
6. Total Length of a BACS bus must not exceed 60m/2360in. and 50 BACS Modules, measured from the BACS WEBMANAGER. 6×4
7. BACS bus cable length between BACS modules for the interconnection. In this example 40cm/16in. Shorter interconnecting cables would increase the distance of 50m/1970in. accordingly, longer interconnecting cables would shorten the distance of 50m/1970in.
8. Max. number of BACS Modules is 512.
9. Max. distance from BACS WEBMANAGER to BACS CURRENT SENSORS should not exceed 10m/395in.
10. Max. distance from BACS WEBMANAGER to BACS CURRENT SENSORS (1-16) and BACS GX_R_AUX Dry-contacts (1-4) should not exceed 50m/1970in. in total.

BACS – Installation with 2 or more BACS Webmanagers

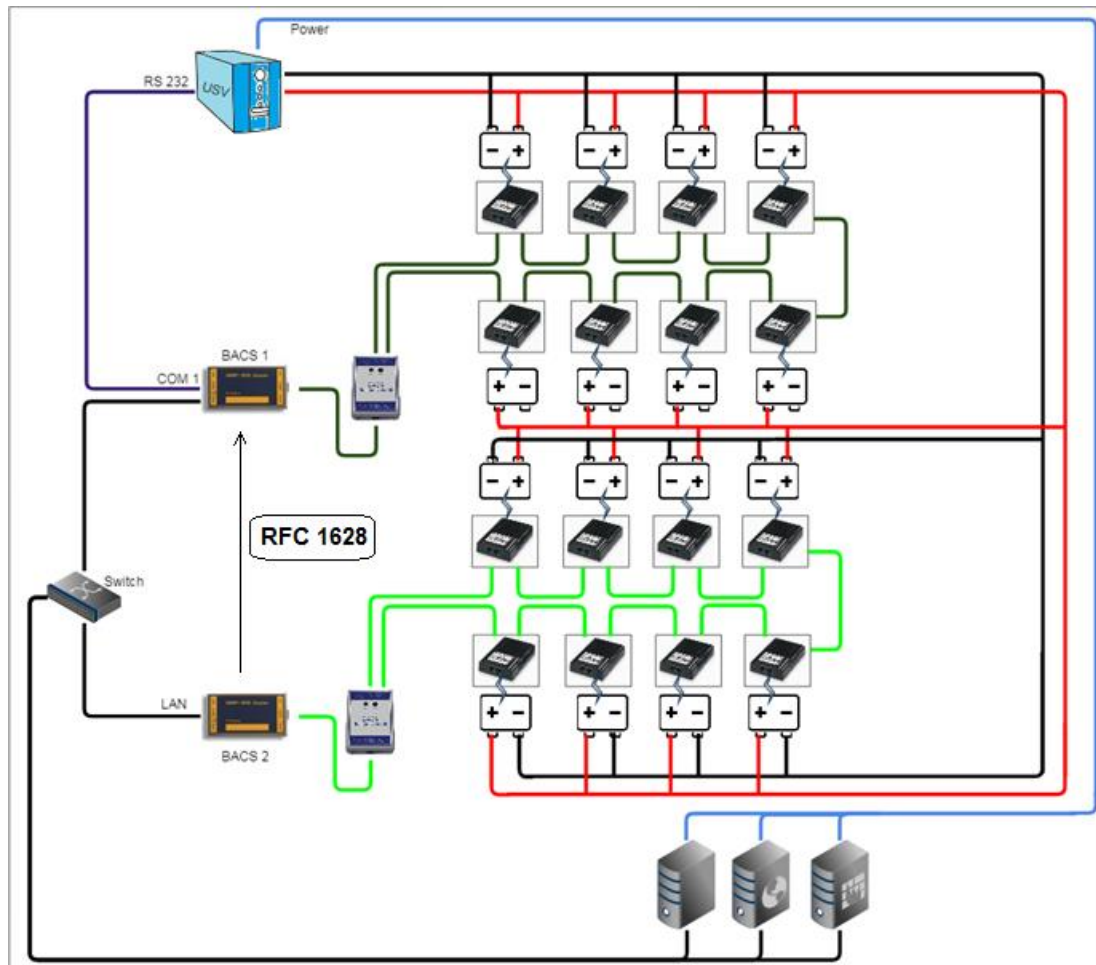

The number of batteries a single BACS installation supports is limited to 500 batteries. If more than 500 batteries are in use, BACS supports the installation and coordination of several BACS webmanagers. In this installation example, two BACS systems were coordinated with each other to jointly manage a large battery field.

Following this installation method, there are two basic things you need to consider:

- 1- Each BACS Bus has to be run with it's own BACS Webmanager

Two BACS web managers are not allowed to address and govern the same BACS modules - they would interfere with each other. If you have more than one BACS Web Manager in use, make sure that each BACS network forms a closed system for itself. The BACS bus itself will not work with an uplink to two different BACS Webmanager.

- 2- All Batteries inside a BACS installation have to be charged / used by the same UPS

As soon as the batteries of different UPS systems are charged and discharged, they are completely independent UPS systems. It would be an invalid battery condition if e.g. A UPS indicates a discharge state, but the monitored battery is actually charging because it belongs to a completely different UPS with its own circuit.

In this example one UPS loads all batteries. To unleash the full regulation power of BACS, BACS 1 is connected to the UPS via RS232 cable while BACS 2 receives UPS data from BACS 1 by LAN via the RFC 1628 smart UPS interface. By doing so, a numerous redundant reactions and very complex configuration options are possible to think about.

Note

Each BACS Web Manager is also a complete system for UPS and building monitoring. Since an emergency can be more than just a power outage, you can control all installations like lifts, access control, lights, lifts, etc... A CS141 based system can perform emergency management of an entire IT network, co-ordinate communication with parent and child systems, and much more.

With each additional web manager that joins your network, connectivity, control, and monitoring will be increased.

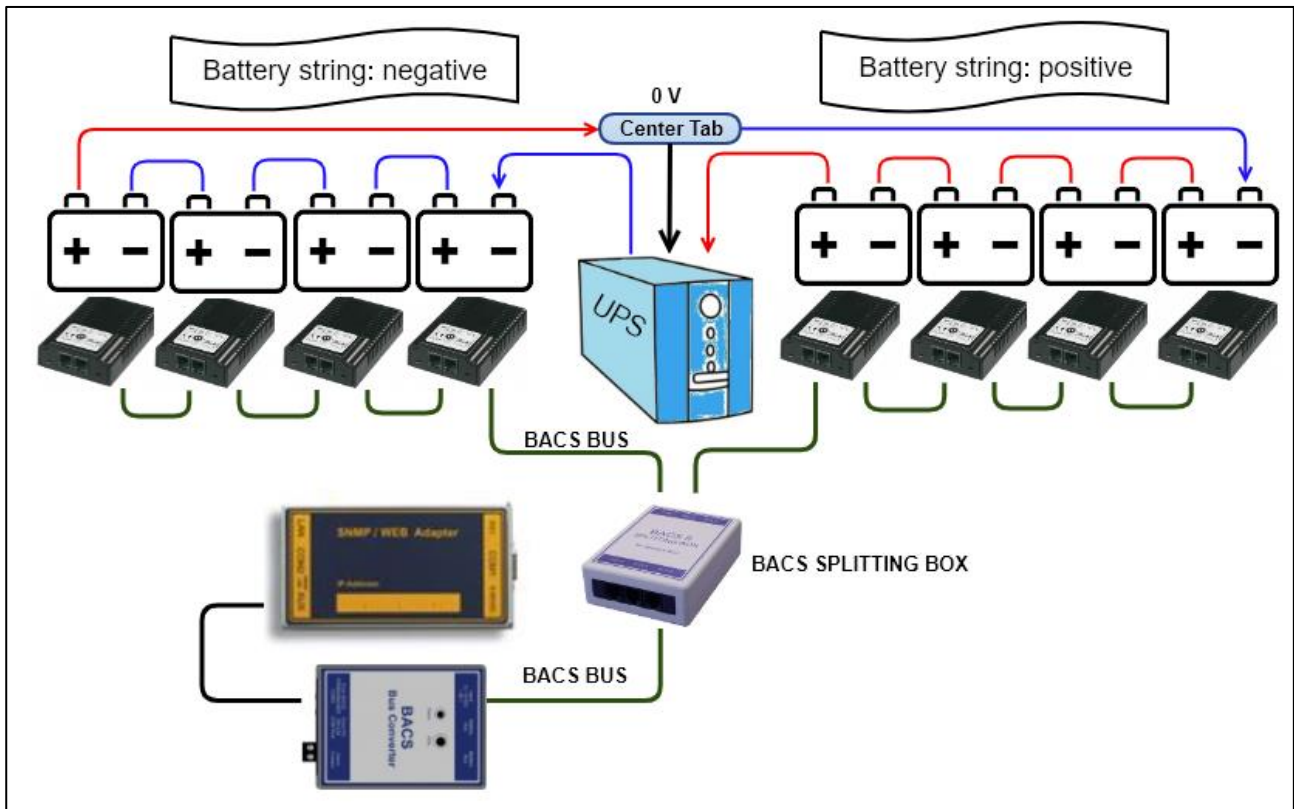
BACS – Installation bei einer USV mit Mittelabgriff

Modern UPS systems use a center tap, which increases the efficiency of the entire system.

Since the two battery strings are arranged symmetrically, problems with the batteries can be recognized, among other things, by the fact that the voltage difference in the center tap is ideally 0.0 volts.

So überwacht BACS die Strangspannung bei Mittelabgriff

While the UPS usually does not notice at this early point that a general problem could be present, BACS can not only determine what caused the imbalance on the basis of the individual consideration of each individual battery, but also warn in good time before all the batteries start charging due to incorrect charging behavior UPS can be affected:

BACS actively intervenes in the charging process and regulates each battery individually, so that the ideal condition of 0.0 volts can almost be achieved at the center tap.

The result of this is that the drift of the voltage is not just be displayed as a general phenomenon, but also the reason be spotted and investigated by evaluation of the current data situation.

Note:

When using BACS, each battery is looked after individually and any problems are reported - since the quality of the charging current is checked regardless of the active control and the measurement results, monitoring the string voltage in a UPS with center tap provides additional protection:

In case of doubt, conclusions can be drawn about the general system status of the UPS itself. Since the individual results can be evaluated by using the professional analysis software BACS Viewer, all information about UPS and for each individual battery is available.

Preparing batteries

Before you can connect the BACS modules, the batteries must be prepared. In addition to the general safety guidelines for work on live components and live cables, please note the following when handling the BACS power cables: Each BACS measuring cables provides an own fuse, integrated in the positive pole of the cable.

As soon as faulty currents leave the tolerance range, these fuses trip in order to interrupt the contact between the BACS module and the associated battery. By doing so, the BACS module will be protected from damage.

Please note, this fuse is not designed to be removed or repaired. The entire cable need to be changed during maintenance work at the according battery:



Short circuits inside large battery systems are very dangerous depending on battery type, it can lead to explosive gases, escaping high corrosive acids as well as acid gas. It may also lead into fire feeded by chemistry.

Never try to replace or repair the fuse!

During initial installation, please obey following:

Once load is connected to the BACS cable, current will inevitably flow when as soon as contact with the battery poles is established. During installation work, an unnoticed repeated brief touching of the battery poles can may trigger fuse while connecting to the battery. In some cases, the fuse will continue working for the moment but is permanently damaged and will trigger short time later. For this reason, there is an installation row to be followed:

First connect the cables to the battery poles and then connect the BACS modules to the pre-coded connector. This will prevent such an internal damage at the fuse.

Since battery connectors may vary depending on model and manufacturer, the basic connection procedure is always the same procedure:

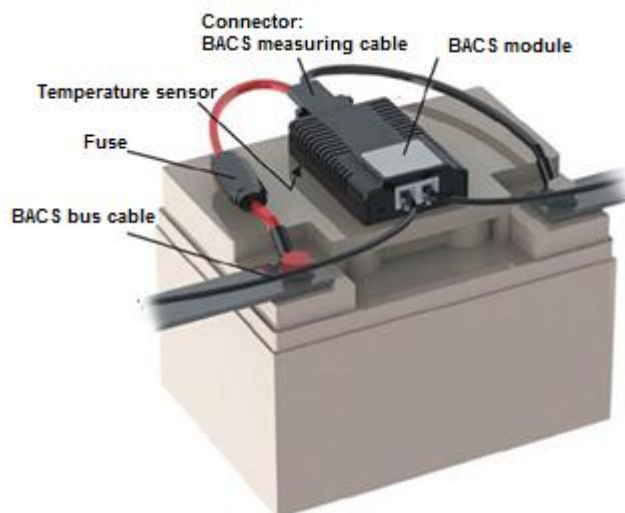

Connect the BACS measuring cables to the poles of the battery. Ensure not reversing the polarity of the cable, the fuse in the measuring cable will be triggered immediately and the cable need to be exchanged:

- Red cable: Positive pole of the battery
- Black cable: Negative pole of the battery

When fitting measuring cables, keep in mind to grant enough space for the later installation of the BACS module:

As the BACS module among other things provides a built-in temperature sensor the module must be attached to the battery in away that the internal sensor is placed ablut 1-4mm from the battery case. By doing so, the module will be able to measure the air temperature close to the battery.

Connecting a BC5 measuring cable to terminal ports of batteries at 6V - 16V

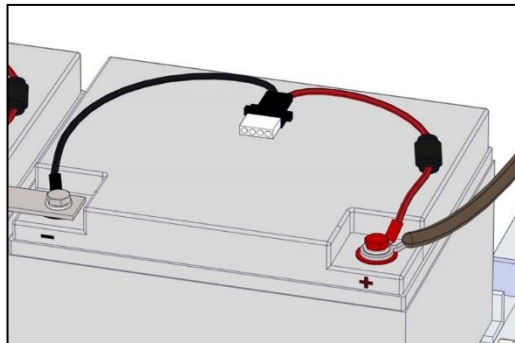
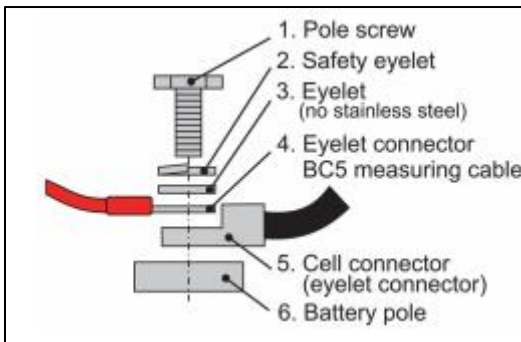

When connecting the battery terminals, please observe the torque values specified by the manufacturer, as otherwise you may damage both the battery and the terminals. Furthermore, please refer the manual of the battery model - depending on the manufacturer, there may be design differences to the installation examples in this manual.

How to connect the BC4B test cables to 1.2V - 2V bipolar batteries

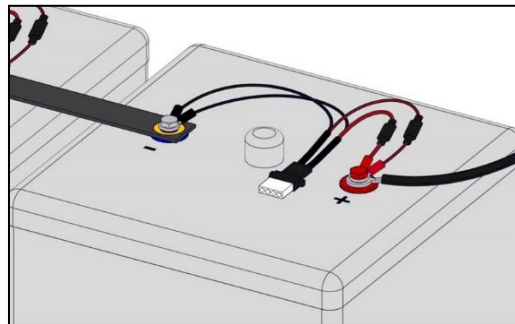
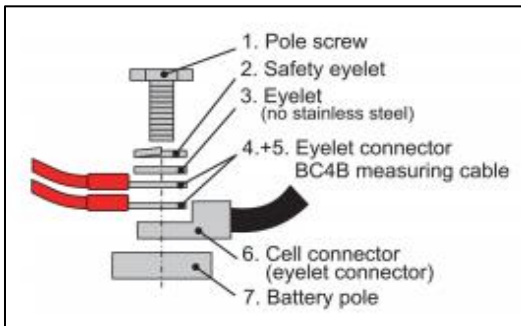

The BC4B measuring cable provides 4 connectors: two for the positive pole and two for the negative pole. When installing, pay attention to the color coding as well as the correct connection. Wrong wiring will trigger the measuring cable build-in fuse - the fuse cannot be repaired or replaced. To avoid damaging the battery as well as the measurement cable, use the torque ratings tested by the according manufacturer.

How to connect the BC4B test leads to four-pin 1.2V - 2V batteries.

Some manufacturers use batteries with four contact points. Coming with this design, two contact points are assigned to a positive or negative pole. Since the BACS measuring cable provide 4 connectors, they must be fitted accordingly to the battery.

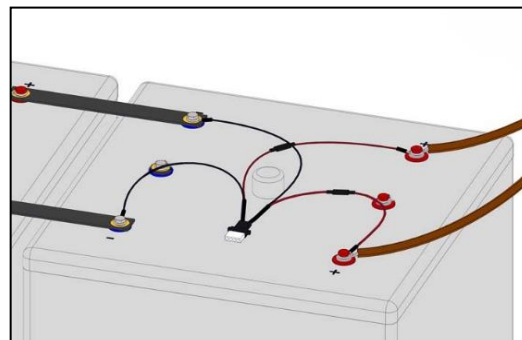
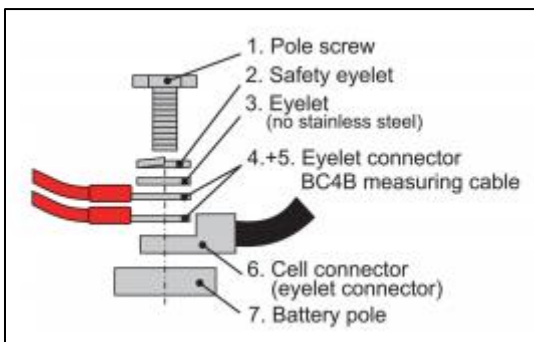

Mounting the BACS module at the battery

Please not the preconditions

- there is no dirt on the surface.
- The surface is free from fats, silicone or other coatings.
- The site is easily accessible for maintenance or subsequent service
- If possible, do not cover any valves or cooling fins
 - o In the case of sealed batteries, velcro tape can also be attached directly on it if there is no other way. An AGM valves would in case of opening separate the velcro connection and the pressure escapes.
- For low maintenance batteries and wet cells, keep at least 10 cm distance to the vent pipe

Before installing the BACS modules, carefully read the installation and maintenance instructions for the corresponding battery.

Wiring the BACS module



The BACS cables are coded and standardized, an erroneous connection is normally not possible.

Connect the BACS bus cables to the modules:

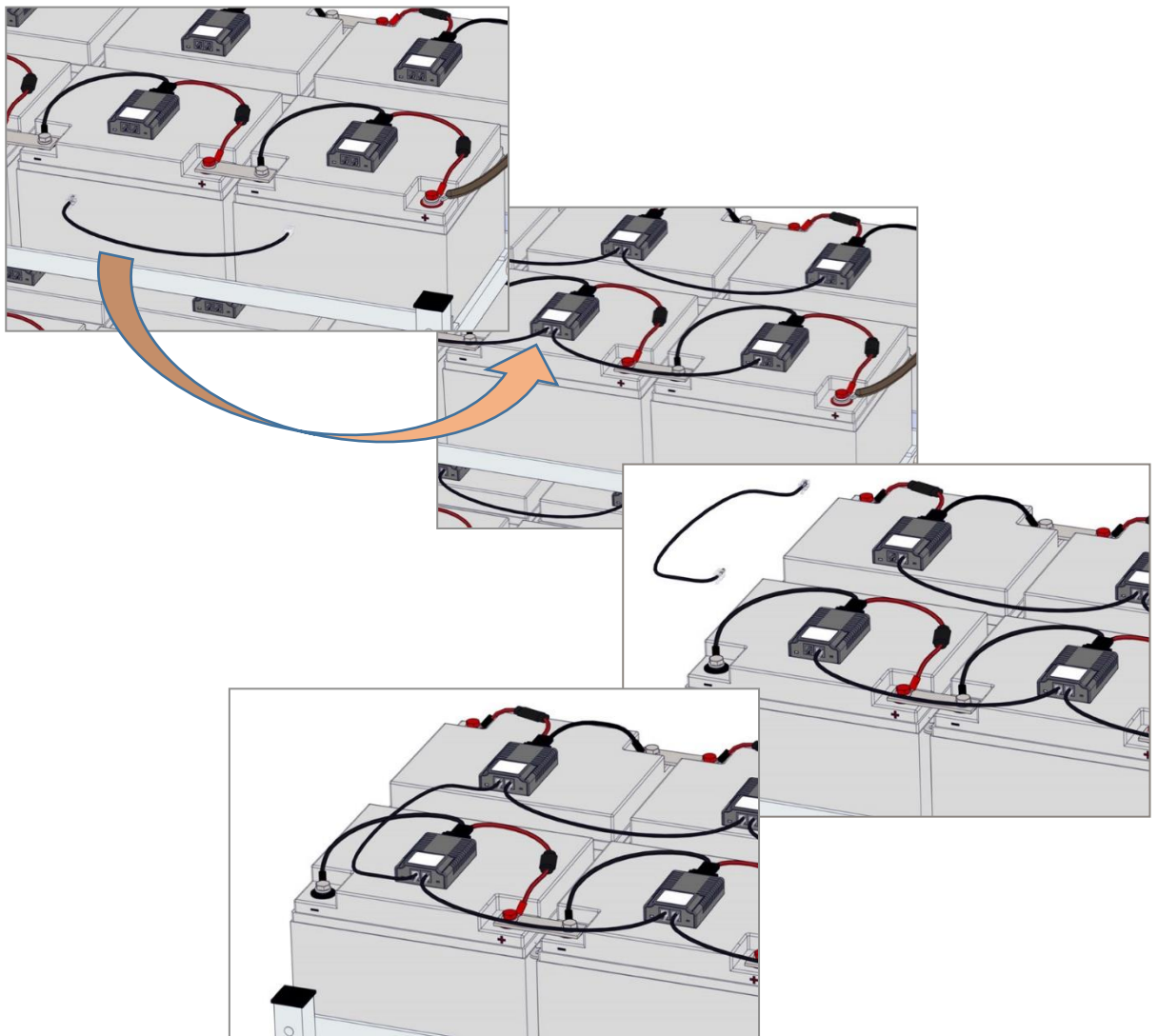

For larger cable lengths and installations, please take care for ...

- the maximum cable length including all modules must not exceed 50 m
- Do not install more than 50 modules per cable harness- If more than 50 batteries are in use, a plitting box is mandatory to split the battery site into two different strangs.
- not exceeding the total number of 500 modules.
- installing the modules that the connection sockets are not live after connecting the cables.
- avoiding excess cable lengths

Note

keep an eye on logical cable sequences when connecting - BACS does not tell you how to connect all modules or in which order you address the modules. For technical reasons, a network short circuit is not possible by placing rings within an installation. Structured cabling and related documentation, however, facilitates system maintenance, especially when individual modules need to be replaced within the installation.

Furthermore, if using a splitting box and set up several strings, a structured hardware configuration is mandatory to set up the BACS configuration.

Tutorial: How to mount of BACS BC measuring cables to include monitoring of cell connectors

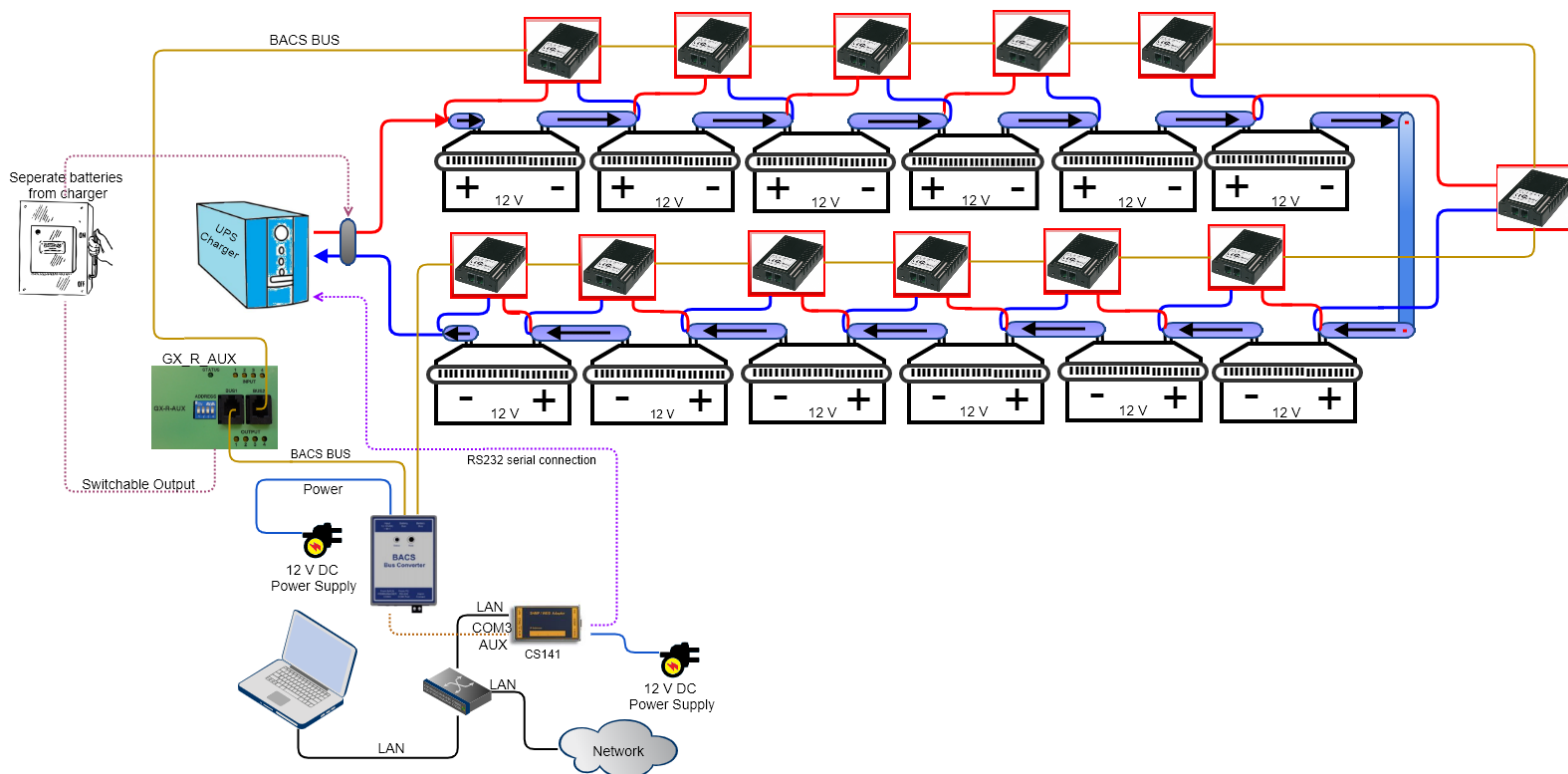

What is the function of the cell connector?

Depending on the type, there are plugged, crimped or screwed transition elements between the individual batteries to connect batteries in series. Due to their function, these connecting elements represent critical areas within the battery system:

- Due to the series connection, the cell connectors pass on the charge and discharge current to the next cell, whereby very large currents can arise depending on the size of the system.
- They are firmly connected to the battery poles and therefore also absorb thermal energy from passing current as well as the heat generated by the redox reactions within the battery. Both the poles of a battery and the screw connections and connecting elements between batteries are repeatedly exposed to mechanical and thermal loads. In this way, the thermal energy can also be transferred directly from one battery to the neighboring batteries. The connecting elements here are normally standardized components that can be neglected accordingly.

Why you should monitor the connectors between batteries?

If failures occur during installation or maintenance, such as torque values not adhered to (incorrectly tightened, over-tightened, etc.) or the usage of incorrectly dimensioned and damaged connecting elements, it can lead to system-critical failures and even a battery fire within a few minutes. If you now only monitor the battery itself in addition to the general charging current, a problem with the connecting elements between the batteries will not or can only be determined to a limited extent, e.g. due to unusual temperature developments or deviating charging currents, etc.

While the temperature developments can still be localized, unclean currents are difficult to localize - it is difficult to narrow down exactly which element causes this loss.

It may make sense in the highly critical system area to include the connection modules in the battery monitoring.

How to include the connectors between the batteries

Classically, the BACS-Module are installed as followed:

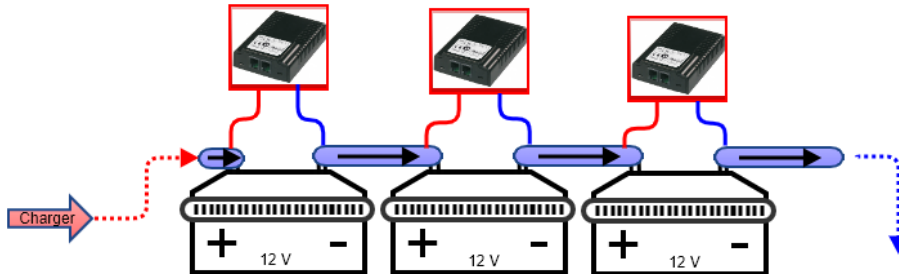

Jede Batterie wird hierbei von einem BACS-Modul betreut und entsprechend geregelt. Grundsätzlich reicht dieser Schutz aus, da ein Problem batteriebezogen auftritt. Dabei werden Neben dem Widerstand auch Innenwiderstand und Temperatur der Batterie gemessen. Sollte es zu einem Problem kommen, wird das entsprechende BACS-Modul diese aufspüren und der Webmanager entsprechend messen.

Wenn die Verbindungselemente in die Messung einbezogen werden sollen, muss der Messpunkt für die BACS Messkabel entsprechend angepasst werden:

Technisch betrachtet wird immer vom Pluspol einer Batterie zu dessen Minuspol gemessen. In der Reihenschaltung bedeutet dies, dass der Pluspol der Folgebatterie vom Potentialgefälle her auch dem Minuspol der vorigen Batterie entsprechen muss:

At a serial connectino of batteries, the netative pole of a battery will be connected with the positive pole of the next battery.

Depending on the measuring point, the connector is included or excluded.

At a serial connectino of batteries, the positive pole of a battery will be connected with the negative pole of the previous battery.

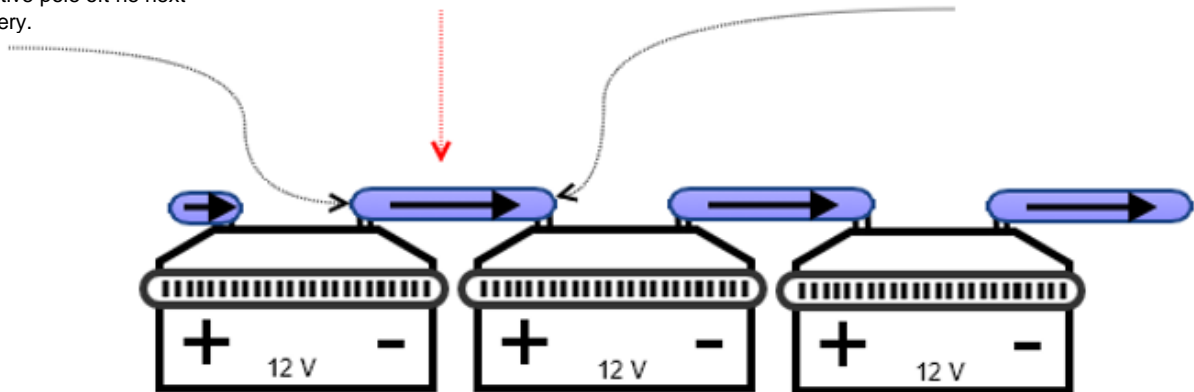

This results into the following structure:

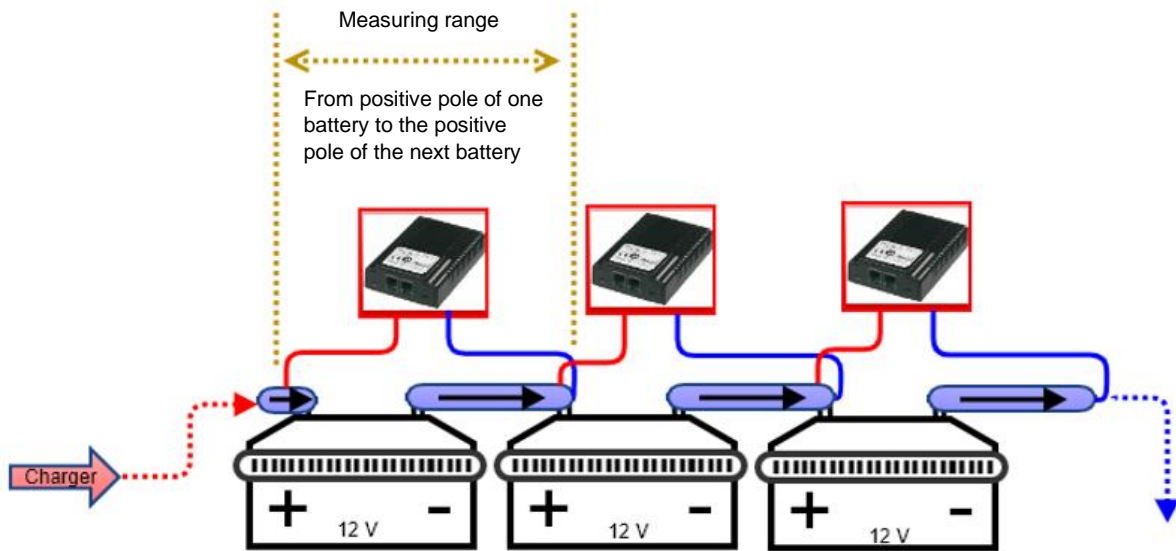

Do values have to be adjusted in the web manager?

No, the BACS modules themselves always take care of one battery - the deviations that the connecting element generates because more material that has to be measured are normally less important. In theory, you could change the existing BACS installation at any time and integrate the cell connectors accordingly.

What can be achieved with this measurement setup - an idealized example system failure analysis

Basically, this measurement method ensures that both the battery and the transition to the next battery are checked.

In this way, if a current sensor in the string reports a deviating current flow, it is easy to spot the battery with the problem is to be sought for:

With the internal resistance measurement of the batteries, the connector is included: If the measured values reach questionable values, the corresponding module will work independently and make itself noticeable.

Otherwise, the problem can be identified by evaluating the data situation:

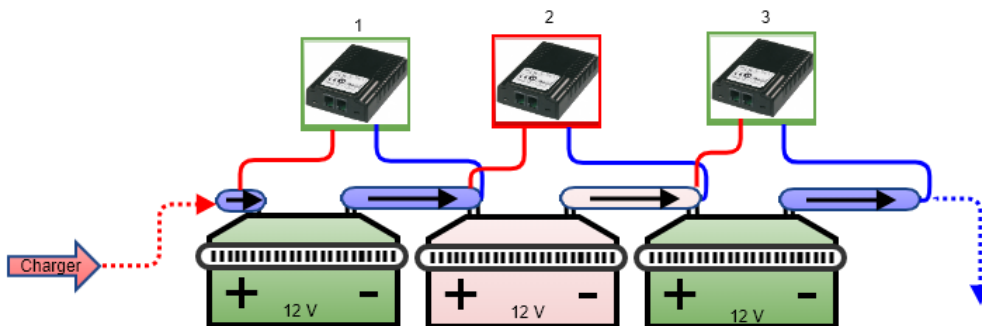

The entire battery string provides strange fluctuations in the flow of electricity. In this example you can see an unusual internal resistance in BACS module 2. The problem can be narrowed down as followed:

BACS-Modul 1 shows no problems:

As a result, all screws on battery 1 must be properly tightened. The same applies to the input screw of battery 2, since the connector is measured via the BACS module 1. If this connector were loose, you would have to see it in the measurement results of BACS Module 1.

The same applies to BACS-Modul 3:

The measurement extends from the positive pole to the positive pole of the subsequent battery (i.e. battery 4) - so the input screw of the connector coming from battery 2 must also be OK.

BACS module 2 reports a strange internal resistance

Likewise, there can be no problem with the incoming screw terminal from battery 3, since BACS module 3 monitors the incoming terminal from battery 3 and the incoming terminal from battery 4.

There are only a few questions left:

- a. Is the outgoing terminal of battery 2 was not attached properly?
- b. Is there a problem with the connector between battery 2 and battery 3 itself?
- c. Is the battery 2 itself has a defect?

If you want to be sure, you would now look at the temperature data of the 3 batteries and look for abnormalities:

If battery 2 heats up quickly during discharge / charge cycles and is then transferred to battery 3, the fault is clearly with battery No. 2. However, if batteries 2 and 3 heat up evenly above average to the rest, the fault with the cell connector is possible - it heats up very quickly and transfers the heat to the batteries via the battery poles.

Note:

Since the connectors are included into BACS, it is possible to general down times of the UPS and search for a problem - you know what you are looking for. If several batteries are affected, this method allows a strategic overview to plan the maintenance work.

Maintenance: Replacing / Repairing a single a BACS module

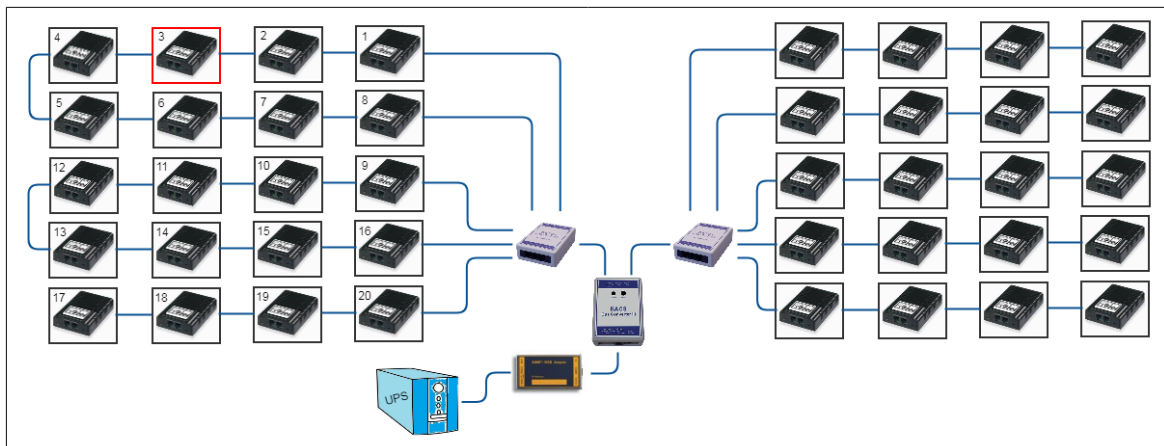

Part 1 – Replace a single module

This example describes a problem with BACS module 3. Since the module 3 comes with a ring wiring, the modules 2 and 4 are still available and work properly. By comparison, if module 19 would fail, modules 17 and 18 would have been equally affected - the connection design is not a ring structure.

However, in case of a failure, the BACS webmanager will report a problem at module 3.

How to proceed: First open the battery separator to avoid an electric shock, safe your work place and take enough time to obey the security rules for working on live parts.

1. Identify the harmed BACS module

Locate the BACS module with the associated battery and remove the BACS data cable. It is important in this context that the exact ID of the BACS module is known so that you do not accidentally replace the wrong module.

2. Remove the BACS data and measurement cables

Remove the BACS data cable as well as the measurement cable. Please note that the BACS measuring cables installed on battery side do not need to be removed - the changed BACS module will be re-connected.

3. Install the spare BACS module

First, connect the single BACS module to the BACS Webmanager, Login and enable the BACS programmer. Read out the current BACS module ID and then program it to "0". That install the module within your BACS system, connect

the BACS measuring cables (if needed) at the battery poles, connect the BACS Bus cables and finally connect the BACS module to the measuring cables.

4. Open the build-in BACS programmer and configure the spare module

The module is currently with ID 0 in factory default state. Due to the fact there is only one module that provides ID 0, it is possible to set manually ID 0 to the ID of the broken BACS module. After leaving the BACS programmer mode, BACS will initiate and the new module is active.

Part 2: Replacing a temperature module

Some module revisions have a temperature sensor that can possibly be replaced on site. These instructions show how you can replace such a sensor.



1. *Preparation*

First disconnect the BACS measuring cable from the module and disconnect the BACS bus cables. Take the module to an antistatic work place to avoid possible damage from electrostatic charge.

2. *Open the module*

The module is designed for easy opening without additional tools:

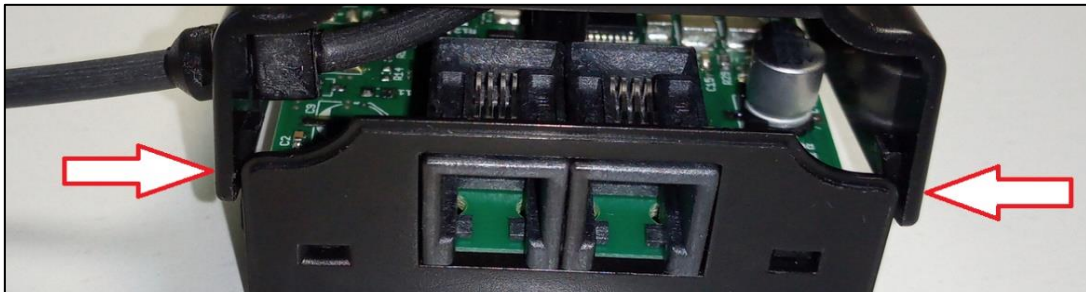

On the front of the module, there are two retaining clips on the left and right, which can be easily released by carefully bending the cover. By doing so, the cover shell can be removed from the module.

3. Replacing the temperature sensor

Depending on the type of module, the installation place of the temperature sensor differs:

The internal sensor

The internal sensor is attached at the bottom of the of the housing:

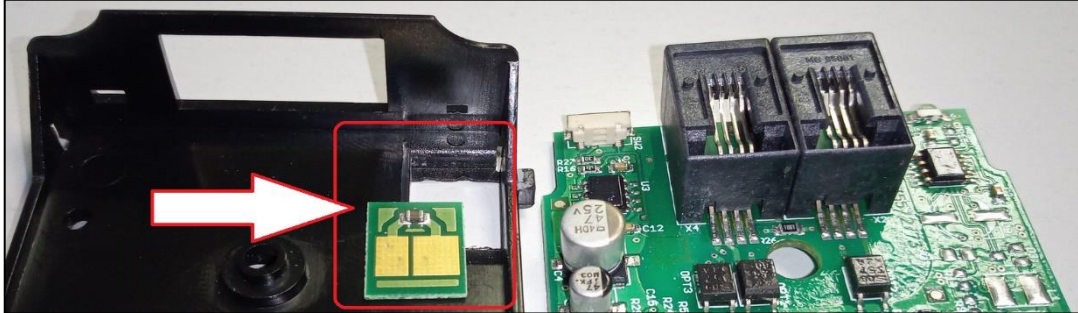

Remove the module board to get access to the sensor. You can then remove the sensor from the shell with a slight pressure from below. Insert the new sensor. Pay attention to the correct installation direction - in this special case the sensor board can be assembled the wrong. If assembled correctly, the two clamps on the back of the module board will press on the contact plates on the sensor board.

The external sensor

You do not need to remove the module board. Just remove the connector off he sensor cable.



The connector is coded so that it only fits in one direction on the module. When carrying out the work, make sure that the ESD guidelines are observed to prevent electrostatic discharge during assembly - these can damage electronic components.

4. Re-assembling the module

Modules with the internal sensor



Place the rear retaining bracket into the module housing and snap the front retaining clips into place with slight pressure.

Modules with an external sensor

First place the strain relief at the corresponding recess in the upper module shell:



Then reassemble the module accordingly. Ensure when putting the two shells together, the cable of the external sensor is behind the plastic web for the module screw to avoid damaging it when using a DIN rail:

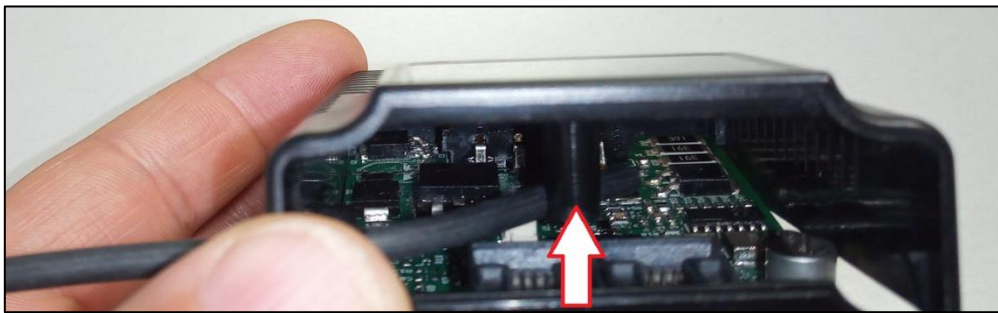

Initial BACS Installation: Configuration of BACS

General battery data

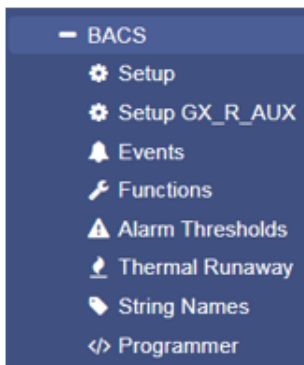

- System tab: BACS
- **General setup for batteries, modules and sensors**

Open the general battery configuration dialog and enter required battery data:

Nominal Battery Voltage	<input type="text" value="12"/>
Nominal Capacity per Battery	<input type="text" value="7"/> Ah
Number of Batteries	<input type="text" value="1"/>
Number of Battery Strings	<input type="text" value="1"/>

- What is the battery voltage of used batteries?
- What capacity provide the batteries?
- How many batteries are installed?
- How many strings do you want to set up?

During installation and configuration process, you may choose between different procedures - Since each procedure comes with its specific advantages and disadvantages:

In this case, it is up to you to decide whether first configure the BACS modules and then set the number of batteries or first configure the number of batteries and set up the ID of the BACS modules during installation.



How to find general battery data:

Since these data are mandatory for BACS module configuration, please refer the data sheets of the batteries as well as the name plate attached to the batteries:

In this configuration example, the voltage is 12V with a capacity of 7Ah

Nominal Battery Voltage

Define the voltage each single battery provides. Please note that you may choose between different battery models as long as the voltage is identical:

it is not possible to combine different cell voltages!

unterschiedliche Modelle wählen, jedoch muss die Spannung immer identisch sein.

- *Battery Model Type*

In order to optimally manage connected batteries, the BACS Webmanager needs to know what type of batteries are involved - the charge/discharge curves vary greatly and depend directly on the battery chemistry used for the UPS solution.

- *All Lead Acid based*

This battery type includes all battery technologies based on acid/lead batteries. Whether acid/lead, gel or AGM, the technology behind them is known for its cheap and robust construction. However, they are somewhat temperature-sensitive, which has a direct effect on service life and discharge curve.

- *NiCd – based Batteries*

The general energy density of this battery technology is very good. Batteries of this type are insensitive to cold (down to -40°C) and can be charged quickly. As a disadvantage, however, one has to take into account not only the memory effect but also the poor environmental protection: An incorrectly used NiCd battery tends to break quickly.

- *LFP - Lithium Iron Phosphate*

The special feature of LFP batteries is that although they have a moderate energy density, they are very stable in terms of battery chemistry and are therefore popular if you need batteries whose tendency to thermal runaway is rather sluggish.

Note

What does the option "Other" do?

All three technologies mentioned above cover a wide range of battery models and provide usable and meaningful results in capacity measurement. However, in addition to the standard technologies, there are also numerous unclassified or experimental approaches and special solutions - in fact, whose charge/discharge curves are still largely unknown.

The core function of BACS is compatible with any battery technology, but for the display of the capacity, key data of the respective charge / discharge curve are necessary. If you select "other", you tell BACS that the required key data of the charge / discharge curves are not known and therefore no statement about capacity values can be made. The corresponding display will therefore be hidden in the BACS Monitor.

Capacity per Battery

Enter the capacity of the batteries in ampere hours. Please note that manufacturers decide how to specify this value inside datasheets. If necessary, convert the values beforehand. This value defines the level of Equalization:

According to the AH value, the BACS modules will be allowed to roll out a maximum Equalizing:

An AH value under 150AH will limit the provided Equalizing power to the size of such smaller batteries, beyond 150AH BACS will use its full Equalizing power which is available for this module type.

Number of batteries

Define the total number of batteries within your BACS installation.

As an example, if you use 40 batteries inside your system, enter 40. Since each battery gets its own BACS module, The BACS webmanager will search for a total of 40 BACS modules, starting with ID 1. The ID 0 is not allowed during normal operation.

Number of battery strings

Number of battery strings defines a logical assignment of the configured batteries in combination with built-up batteries. Among other things, the number of strings is defined by the physical wiring of the batteries. As an example, 20 batteries may be installed into one positive string and 20 into the according negative string. Such a middle point battery setup requires in BACS a configuration as "2 strings" since the charger handles the positive and the negative string separately. Other installation types would be in this case of 10 batteries in string 1, 10 batteries in string 2, etc.

According to this context, it is important the physical wiring of the batteries match the logical structure of the strings. The BACS system uses the sequential numbering of the BACS modules during initialization and divides them by the number of battery strings..

If arbitrarily connecting the BACS modules to the batteries and activate BACS, BACS will logically initialize the BACS modules into a string with IDs 1-10, followed by IDs 11-20, ...

Physically the BACS modules may form up a shredded string that is logically correct. As a consequence, BACS would receive wrong readings and possibly not even start: The strings will be displayed separately in the BACS monitor and treated accordingly during regulation.

When assigning the BACS modules, pay attention to the position or numbering of the batteries in the battery compartment itself to match the logical assignment with the current installation: Ideally battery no. 1 also received the BACS module with the number 1.

Something more to take an eye on

For technical reasons, it is not possible to connect and manage an unlimited number of batteries to a single string. From 50 batteries onwards, we recommend to "split" the BACS bus, ie to define two different cable strings per definition in order to keep the cable length as short as possible.

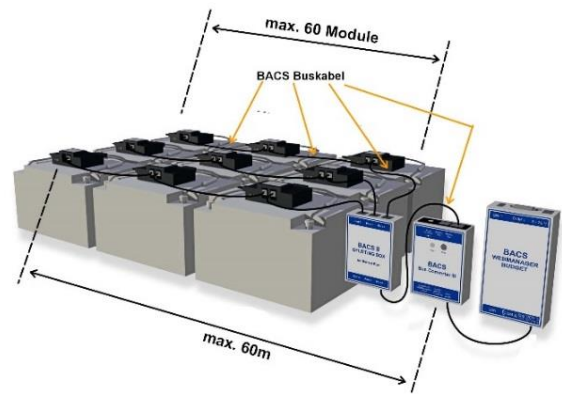

Note

With String Names it is possible to enter a freeform label for the battery string. you enter a name for up to 16 battery strings before configuring the BACS modules. However, the number of strings will be define at Number of battery strings. that will be shown. Entering a name does not automatically increase the number of battery strings.

Two Jars / Cells per module: The configuration NiCd based batteries differs

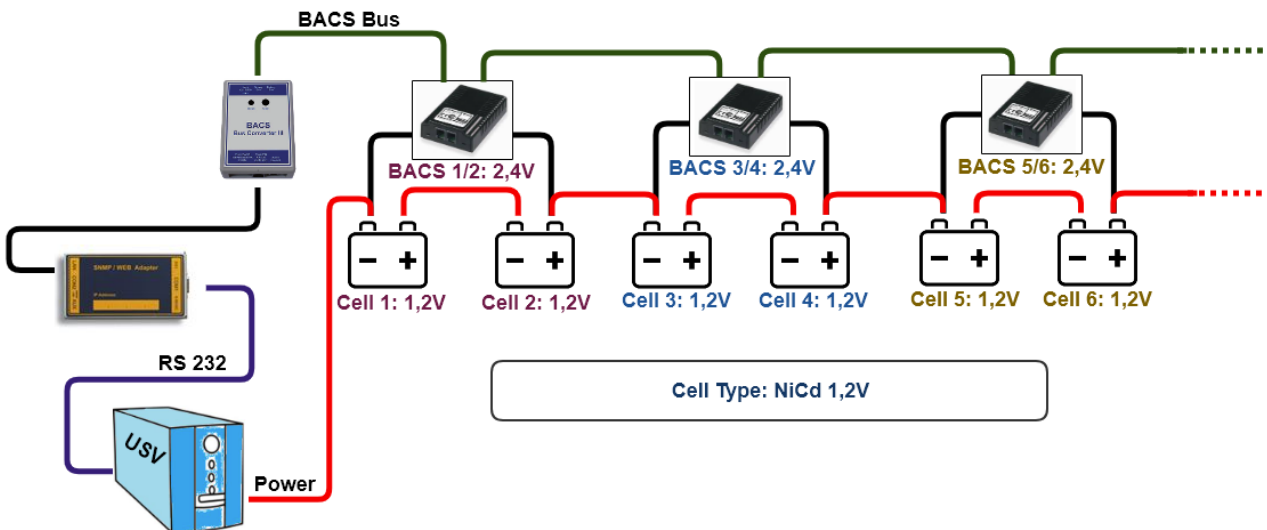

NiCd - based batteries use a cell voltage of 1.2 V - therefore, with this type of battery, 2 batteries will be managed by a single BACS module.

Configuration

To handle NiCd correctly, BACS must be informed that in this case 2 batteries are be combined and will be managed by one module. In order to avoid a configuration failure, this function can only be activated if the nominal battery voltage has been set to 2 volts.

At Devices>BACS>Setup, the according configuration menu can be found:

Nominal Battery Voltage	2	→ Set the nominal battery voltage to 2 V
Nominal Capacity per Battery	7 Ah	→ Enter the capacity of the batteries
Number of Batteries	6	→ Enter the number of batteries in use*
Number of Battery Strings	1	→ Define the number of battery strings
Two Jars / Cells (NiCd) Per Module	<input checked="" type="checkbox"/>	→ <u>Enable Two Jars / Cells</u>

*) Since you have combined two batteries for measurement and management purposes, the number of batteries is twice as high as the number of installed BACS modules. That's why you need to enter the number of batteries and not the number of BACS modules.

The BACS Monitoring Screen:

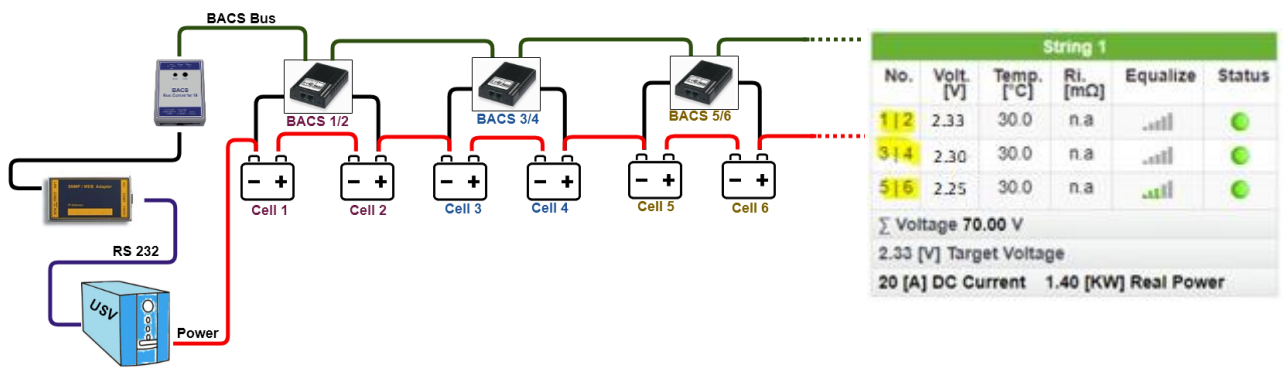

After initialization, BACS will not list the number of modules in use, but the number of batteries actually managed by the modules.

Helpful information about the BACS system

Information	
Battery Manufacturer	→ Manufacturer of the battery
Battery Type	→ Installed battery type
Battery Location	→ Where are the batteries installed?
Battery Installation Date	→ Installation date of the batteries
Contact Person	→ Responsible staff
Contact Person Phone	→ Direct phone contact data of staff

Battery manufacturer and type

Enter the designation as free form text. If useful, add some information about its function or the intention of this battery system or in special cases chemistry used for this battery room. If an incident occurs and rapid interaction is mandatory, this information can increase the average response time. On the other hand, misleading or poorly documented terms can cost valuable time.

Battery installation date

The battery installation date indicates the date of initial battery installation. Since a system can be upgraded with BACS at any time, it is important to be familiar with the difference of a battery installation date and the installation date of BACS.

You will usually find the battery installation date on the battery itself as "date of manufacture"

Contact person and phone contact

In case of maintenance work or incidents, responsible staff can be contacted to shorten response time.

Note

If wanted, BACS can send general contact information to a custom mail address and contact responsible staff directly. However, your entry at contact phone cannot be used for automatic SMS notifications - An SMS modem or IP modem must be configured separately.

BACS module basic setting

Module	C20	→ Choose the module
Equalizing on	<input checked="" type="checkbox"/>	→ Enable / Disable BACS
Optimize Scan	<input type="checkbox"/>	→ Optimize Equalizing scan
Choose Discharge Detection Source	Automatic	→ What to use as discharge detection?

Module

Different voltages on the batteries require different BACS modules - please ensure to select the BACS module type fitting to your batteries. Depending on the voltage selected for the batteries, it will display modules fitting to the voltage. Currently the following modules and voltages are available:

Cell Voltage	Selectable module
2 V	C40 / C42
4 V	C41
6 V	C30
12 V	C20 / C21 / CSYM
16 V	C23
24 V	CSYM

The screenshot shows the configuration interface for a BACS module. The 'Nominal Battery Voltage' is set to 2V. Below it, 'Nominal Capacity per Battery' is set to 7 Ah. The 'Module' dropdown menu is open, showing options C40, C40, and C42, with C42 highlighted. Other settings like 'Equalizing on' (checked), 'Optimize Scan' (unchecked), and 'Choose Discharge Detection Source' (Automatic) are also visible.

Obey the correct settings. An unsuitable combination of UPS, modules and batteries may lead into system failure and damage.

Equalizing on

Equalizing is a protected voltage distribution control system inside a battery pack, the batteries will differ from each other. As a consequence, they need individual regulation of charging voltage to reach the target charging voltage of the charge controller.

Since Equalizing intervenes in the charging circuit and actively regulates,

it may be necessary for new installations to operate the batteries for some time without this regulation. This will allow batteries to "form" up each other. During this time window, new batteries will be operated without regulation, the voltage differences need to be tolerated. Please contact your battery manufacturer if their battery products need such a time window and how long it should take until Equalizing can take over in order to protect your batteries.

The installation of the BACS modules as well as fetching measuring data with the BACS system is completely independent to equalizing - you can install and operate all BACS modules without charging control and active regulation. Equalizing can be activated at any time. If activated, BACS will take over the care of the batteries.

Optimize Scan

Normally, only a small amount of data is collected and stored during trickle charging. Since the parameters of the battery will not change very much during a trickle charge, only a small amount of data is collected and stored. This will change during discharging:

When discharging, considerable amounts of data are generated. Furthermore, BACS increases the sampling rate in order to record the event as accurately as possible during an evaluation by additional freewaer tool BACS VIEWER. The scan optimization reduces the data points to the measurement of voltage values. by doing so, changes in a discharge cycle can be recorded much more accurately.

Discharge Detection source

BACS offers alternative options to differentiate between a charge and discharge cycle. By default, BACS will automatically select the best source and, if necessary, query alternative sources:

- *UPS*

The UPS provides the fastest and most reliable detection rate due to the fact it will switch in case of a powerfail to battery mode. Depending on the design, the BACS system can use the CS141 slot card, an RS232 interface or even the RFC1628 network interface in the network to obtain the information, among other useful information, about detecting a discharge.

- *Current sensors*

The direction of the magnetic field induced by current flow is a probate method to figure out if the batteries are currently in state charge, trickle charge or discharging. Although the detection rate is slower than querying the UPS. Current sensors provide additional measurements of the quality of the discharge current. The current sensor selection would be the best detection source if a UPS state query is impossible.

- *BACS sensors*

The BACS sensors can also perform a discharge detection:

The modules measure the battery voltages - from the moment the voltage drops below the rated voltage, BACS will assume a discharge is in progress. Since the batteries take a while to fall from the trickle charge to the rated voltage and stay there for a while before dropping below this value, it is a reliable but very slow option to figure out if a discharge is in progress.

Normally, this detection source is selected if neither UPS nor current sensors are available.

Note

A rechargeable battery needs some time to fall from trickle charge values to its rated voltage. This natural process can be misinterpreted as "discharge". For this reason, a battery monitoring or management system needs the ability to differ between this natural process and a battery discharge:

BACS can do this job and will increase the detection and logging rate only if a real discharge is confirmed.

To improve detection rate, additional current sensors are recommended- if BACS detects a voltage loss as well as current flow, the discharge status is confirmed.

Offset values

Offset Values		
Temperature Offset	<input type="text" value="0"/> °C	→ Enter temperature differences
Impedance Offset	<input type="text" value="0"/> mΩ	→ Enter impedance differences

BACS modules are calibrated on delivery and will give an exact value related to the calibration. However, the BACS system can not know the general installation location and it may be possible that the calibrated measurement results differ from external reference measurements due to the installation site. Air pressure, humidity, ambient temperature and other environmental variables can distort the values collected by BACS:

The calibrated values need to be corrected if necessary.

With the offset values, it is possible to enter correction values coinciding with measurements at the installation location.

Impedance Measurement Interval

Impedance Measurement Interval		
Start at	<input type="text" value="08:00"/>	→ First impedance measurement log entry
Repeat every	<input type="text" value="12 hours"/>	→ Repeat and log in this time intervals

Due to the nature of their function, batteries are subjected by a partial hidden aging process - a gradual process that cannot normally be observed unless continuous measurement data on the internal resistance are available by chance. For reliable trend detection, it is therefore important to regularly measure the internal resistance of the batteries:

These data logs can be used to identify the real internal age of a battery and thus the probability of a total failure.

Since it is possible to compare all BACS-supported batteries directly with one another using the professional BACS Viewer software, it is possible to identify an unusual increase in impedance and take appropriate countermeasures.

As a default, BACS will automatically take the first measurement at 8 a.m. after initialization or a restart and then repeat every 12 hours. However, you can adapt the start time and repetition intervals to suit your service plan.

Current Sensor



Each BACS module already provides its own charge / discharge detection.

The detection by the BACS modules arises from the need for batteries to generally have a slight discharge curve and lose their charge over time.

However, this charge / discharge detection is realized by voltage measurements of the cell. If the voltage drops below a rated voltage, BACS assumes a discharge is in progress. What the BACS module does not measure is the current flowing through the individual strings during a battery discharge cycle.

In addition to the charge / discharge detection, the current sensor can also be used to check whether the currents are divided equally between the parallel battery strings as well as the average quality and stability of the current.

Installing the current sensor

If you want to use a BACS Current Sensor, enable the BACS CS Current Sensor Connected:

By default, the BACS Web Manager searches for one current sensor per battery string - the number of BACS strings will reflect the number of sensors that need to be found. At BACS monitor, the result will be displayed below the corresponding string.



Premium feature: Only One Current Sensor for All Strings

Usually each battery string gets its own current sensor to get information about real current flow on all strings. In some cases it is desirable by customers to use only one current sensor for a general charge / discharge detection. By doing so, BACS needs to know that only one current sensor is installed:

Enable "Only One Current Sensor for All Strings" and press apply to restart BACS.

After restarting BACS, only one sensor will be automatically displayed. If the current sensor is installed on a string, the ampere multiplier value will get approximate overall current value.

Premium feature: Ampere Multiplier – how it works

The ampere multiplier multiplies the measured current by a theoretical factor in order to draw conclusions about the entire system. The multiplier value to be entered depends on two factors:

1. There are several strings in the BACS system - the number of strings determines the multiplier.
2. For various reasons only one current sensor is available

The multiplier can be used in this way:

- Main string: The current sensor measures main current value = 1
- Single string: The current sensor measures the partial current of the string value = Number of strings

Since the measurements are not very exact In the end, this solution serves only the more accurate charge / discharge detection. It is not designed to determine more information than an exact charge/discharge detection as well as basic information about estimated current flow.

Note

You will get the *best* results with a combination of current sensors inside each individual BACS string as well as using the sensors coming with BACS modules. By doing so, more data can be collected and analyzed:

- General voltage
- Internal resistance of the batteries
- temperature of the batteries
- quality and uniformity of the discharge current itself

However, BACS offers you different graduated possibilities for discharge detections:

1. UPS status

The UPS knows the current charge or discharge status and will provide this information for the BACS Webmanager. To choose this option, the BACS Web Manager must be connected to the UPS. Depending on the BACS design, you can choose between a single device or a modular solution. Even the combination CS141 slot card with BACS BUS Converter can be used.

In other cases the connection is possible via the RS232 interface. If you use a UPS with SNMP access, it is also possible to configure an access via the RFC1628 interface and query the data directly via LAN. Current sensors provide additional current quality detection

2. If no communication to the UPS is possible, you can get accurate information via the current sensors and the BACS modules.

- a. Charge-/Discharge detection
- b. Accurate readings on consistent charge and discharge cycles as well as quality and fluctuations of the current.

In this setup, the BACS modules provide voltage values across the batteries and the current sensors provide values about the current that actually flows per string.

3. If, for logistical reasons, you can only use one current sensor, it will in principle provide an exact charging and discharging detection source. But with one current sensor, it is just possible to provides a theoretical overview of the quality of the current that will flow during charge- / discharge processes.

Obey that the current sensors can be used either on the main line before splitting into single strings or inside a single string after splitting.

a. The main string

At the main string, the total current is measured. You will recognize a very accurate charge / discharge detection as well as information about internal fluctuation in the current flow, but you will not be able to get informations about the strings that may trigger current flow problems.

b. At the single string

Like a main string installation type, you will find a very accurate charge/discharge detection. The difference is, that the single string installation will measure the real current at this strand the current sensor is installed to. You can use the multiplier to approximate the value to reality, but it remains as some kind of rough estimate. What you can see accurate:

If the value for current drops, the problem has to be found in the string where the sensor is installed to. On the other hand, if the value increases dramatically, there is a problem in one of the other strings.

Technically, a more exact limitation feasible in this constellation is not possible and the accuracy depends on the number of strings you have installed - With two strings, it is easy to figure out which string causes trouble. With three strings, two strings you have possible candidates...

4. You can also completely dispense the connection of a UPS as well as the use of current sensor. The charge / discharge detection can be fully mapped by the BACS modules. The modules measure the internal resistance and the voltage of the batteries they are installed on. The modules can measure if a charge cycle or discharge cycle is in progress. But it will need some time. This possibility, however, ignores the current that will flow during charging and discharging.

Enable Current Thresholds

BACS offers you an option to actively monitor the current flow and to react flexibly according to the measurement results. There are two basic scenarios that can be covered:

Scenario 1: Discharge current / charge current

In this scenario, you define the maximum charging / discharging current given to or taken from the batteries.

In this example, BACS monitors that the maximum charging current (Max) may be 2 amps, and conversely, in the case of discharging, no more than 2 amps may be withdrawn.

Depending on the usage scenario, the values can be distributed accordingly. The BACS Webmanager will issue a warning if the discharge / charge currents are not within the specified value range.

Warning Levels			
	Min		Max
String Current	-2	A	2
	Discharge		Charge
String Deviation Delay In Minutes	1		

Scenario 2: general current flow

This scenario assumes that both a known minimum current must be measured via the current sensors and a known maximum current, which generally must not be exceeded.

	Min		Max
String Current	3	A	6
	Discharge		Charge
String Deviation Delay In Minutes	1		

Note:

In which case the configured value range is left?

This can have different reasons, e.g. when emergency pumps start up that need a lot of power to start up.

Enable String Deviation

String deviation compares the currents of the individual battery strings. In an optimal state, the discharge and charge currents should be identical and evenly distributed - a state that is difficult to fulfil in operational practice because each battery develops individual behaviour over the years, which affects the behaviour of the entire UPS solution.

	Discharge		Charge
String Deviation Delay In Minutes	1		
String Deviation	1	A	1

String Deviation monitors the measurement results for 2 events:

Discharge: Power is supplied by the batteries, the batteries are discharging. The discharge current should normally be identical for all strings.

Charge: After a discharge process, the batteries are recharged. The charging current should normally be identical for all strings.

String deviation delay in Minutes

It can always happen that the currents diverge for a short time in case of a sudden load. However, if the currents in one string drift apart compared to the other strings over a longer period of time, this behaviour may indicate a problem. The string deviation delay defines a short time window in minutes during which such deviations are tolerable as a known element of operating reality.

	Discharge		Charge
String Deviation Delay In Minutes	1		
String Deviation	1	A	1

Assign Jobs to Events

Open the menu "BACS Events" under BACS, and search these system events:

>	<input type="checkbox"/>	+	<input type="checkbox"/>	BACS String Current High Alarm	>	<input type="checkbox"/>	+	<input type="checkbox"/>	BACS String Current Deviation Discharge Alarm
>	<input type="checkbox"/>	+	<input type="checkbox"/>	BACS String Current High Alarm Off	>	<input type="checkbox"/>	+	<input type="checkbox"/>	BACS String Current Deviation Discharge Alarm Off
>	<input type="checkbox"/>	+	<input type="checkbox"/>	BACS String Current Low Alarm	>	<input type="checkbox"/>	+	<input type="checkbox"/>	BACS String Current Deviation Charge Alarm
>	<input type="checkbox"/>	+	<input type="checkbox"/>	BACS String Current Low Alarm Off	>	<input type="checkbox"/>	+	<input type="checkbox"/>	BACS String Current Deviation Charge Alarm Off
>	<input type="checkbox"/>	+	<input type="checkbox"/>	BACS String Current High Warning	>	<input type="checkbox"/>	+	<input type="checkbox"/>	BACS String Current Deviation Discharge Warning
>	<input type="checkbox"/>	+	<input type="checkbox"/>	BACS String Current High Warning Off	>	<input type="checkbox"/>	+	<input type="checkbox"/>	BACS String Current Deviation Discharge Warning Off
>	<input type="checkbox"/>	+	<input type="checkbox"/>	BACS String Current Low Warning	>	<input type="checkbox"/>	+	<input type="checkbox"/>	BACS String Current Deviation Charge Warning
>	<input type="checkbox"/>	+	<input type="checkbox"/>	BACS String Current Low Warning Off	>	<input type="checkbox"/>	+	<input type="checkbox"/>	BACS String Current Deviation Charge Warning Off

Jobs are assigned as usual via the configuration dialogue for jobs.

Thresholds for current sensor discharge detection

Thresholds	
Discharge	-1 A
Charge	1 A

The direction of current flow indicates whether the batteries are charging or discharging. In principle, you need to differ between three charging or discharging states:

1. Discharging

The batteries discharge while granting emergency power.

2. Charging

If batteries drop below a certain voltage level, they must be charged. This battery state can be reached via a natural discharge process over time or in case of emergency power usage. The charging process is always initiated and terminated by the UPS / Charger. By "Equalizing", BACS distributes the existing charging current and voltages - Each battery charge is considered individually to ensure the optimal charging.

3. Trickle charging

Batteries tend to self-discharge over time. This process can not be prevented, but slowed down by proper storage. The trickle charge hereby serves to maintain the current state of charge. Normally, a trickle charging will not be displayed.

Depending on the charging behavior of a UPS, certain currents always flow within a system. Due to this fact, it cannot generally be assumed that a current flow is automatically a charge / discharge cycle. Since only two of the possible states are important for the current sensor to detect a charge or discharge cycle, it is necessary to define a fixed point at the current intensity for a charge/discharge cycle.

With the "Thresholds", the values can be adapted to the environment that a clear charge or discharge cycle can be assumed.

The negative sign defines the discharge cycle and the positive sign the charge cycle.

How to configure the BACS modules

Addressing BACS modules: The BACS programmer

The BACS modules can be configured by using the WINDOWS program BACS PROGRAMMER or via the web interface in the CS141 / BACS WEBMANAGER.

To use the BACS programmer in the web interface, navigate to the following menu:

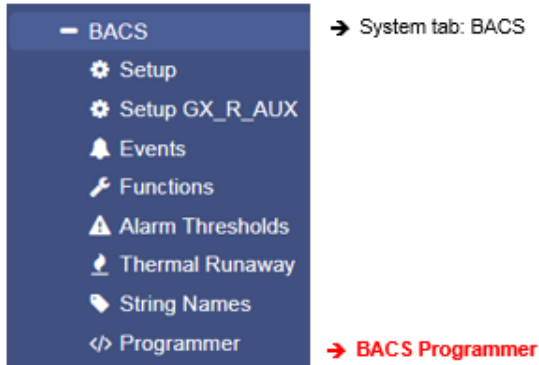

To install, configure, or remove new BACS modules, the BACS system must be put into standby for this time window. First set the Programmer Input Capability to "On":

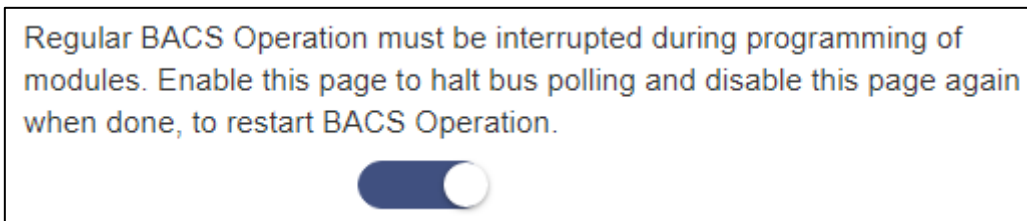

Please note that the button generally describes the state that is currently available. While the Programmer is active, BACS pauses – the current system state can be seen at the top status bar of the Webmanager:

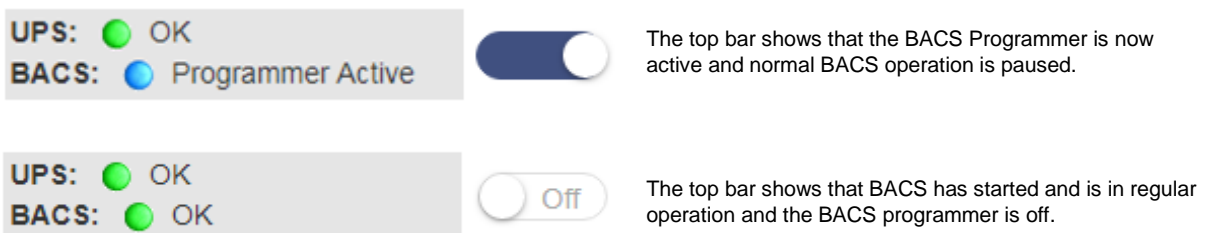

Two conditions will disable the BACS programmer and enable regular BACS functions:

1. Cold start or reboot

During a cold start, the device is de-energized briefly and then reboots. A reboot will be advised by an administrator via tools or directly via the web browser reboot command. In both cases, the default startup setting will start without the BACS programmer set to on.

2. Enable or disable manually

The BACS Programmer does not have an automatic activation function - it is started manually by an authorized user and must be terminated accordingly. If you log off as an administrator from the system, the BACS Programmer remains active, even if you subsequently log in as an engineer.

Note

Always remember to disable the BACS programs after using. An internal watchdog will permanently look if there is activity on the BACS bus. *After 15 minutes without some kind of activity*, this watchdog will assume something is wrong and trigger reboot.

Once you enable the feature, the BACS Web Manager will adjust its BACS status accordingly:

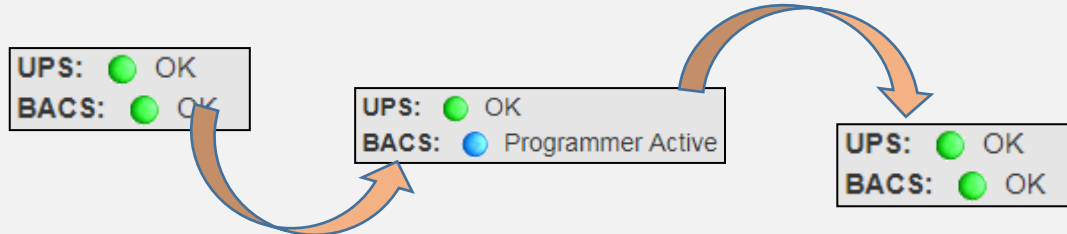

Normal operation and any communication on the BACS bus is paused by user for maintenance work. After finishing maintenance work, the BACS programmer will be disabled and normal operation starts. The BACS bus watch dog is not part of the CS141 - it is placed on the BACS Bus Converter and will interpret the entire communication between CS141 and the BACS modules - and restart the CS141 in case of a communication failure.

Addressing modules*Change the ID*

During initial commissioning, the BACS modules must receive a unique ID in order to be able to register with the BACS Web Manager. In general, these addresses are static, but each BACS module can be reset to factory default or programmed to any other ID.

Because reprogramming is possible, setting up an ID follows specific installation rules:

1. Each ID is unique and it is not allowed to set up one ID twice.

Duplicate registrations will produce errors when initializing BACS because the modules can not be uniquely assigned to a battery.

2. Only sequentially numbered IDs are allowed inside the BACS network.

The IDs are assigned to a specific battery a BACS module is connected to. If 25 BACS modules are expected, 25 batteries are mandatory. You can not "turn on" module ID 26 with a new battery and "turn off" the battery with the BACS module ID 17. You need to reassign the module-ID 17 to the new battery.

3. The highest ID number defines the number of batteries you want to install.

BACS will not scan for 25 batteries with a connected BACS modules, it will exclusive look for 25 batteries with the BACS modules ID's 1-25.

Define an address range

Please remark, resetting modules may be necessary as part of an initial installation - reusing modules for another BACS installation is possible. In that case, the existing modules may still have arbitrary ID's from older installations. On initialisation, all modules need the ID 0.

First define the module ID range you want to reset. You are free to choose a complete range from 0 - 600 or - if wanted - limit their range: 250 - 450.

Check "Reset" and press the Start button to begin. The BACS Webmanager will reset all modules and set them to ID 0. The modules will visually display this process by slowly flashing red.

Range

[Help](#)

Reset

Start

End

Note

In some cases, the modules may not have been reset by the BACS Web Manager, as an example, if a cable is damaged or individual modules are not properly accessed due to external interferences. You can manually reset these modules by holding down the button on the module itself for about 20 seconds.

Set up all modules

When configuring the BACS modules, please note that a BACS module must have the ID 1. Furthermore, the ID's have to be assigned consecutively, otherwise the BACS communication cannot start after the configuration.

Under Start, enter the first ID, under End the last ID you want to assign. With Start, you start the configuration process. You will notice that all modules are flashing fast. The fast red flashing indicates that the modules are in addressing mode.

The following rules meet the automatic addressing mode:

- The first addressed module (ID:1) is of particular importance because the hardware revision of this module is used for the Hardware Revision Integrity Check.
- Only the modules that are in factory default mode (ID: "0") will answer to the BACS Programmer's request.

In the process bar, which address is currently deployed for assignment??

The BACS Programmer provides the last assigned address. If the status "running" shows ID:3", the next module will get the ID 4 on pressing the BACS module button. At the end of the configuration, 7 of 7 ID's are assigned to modules.

In the case of partial addressing, the programmer displays the ID of the last module you programmed:

Feedback des BACS Programmers: Module 1-7 / Gesamtzahl 14 Batterien	
<p>First, the BACS Programmer shows the start and stop address in the status bar.</p> <p>The status is set to "started".</p>	<p>Afterwards, the BACS Programmer will display the number of modules that have already been addressed. In this case consequently the "0", because no module has been configured yet. The status is then set to "running".</p>

Feedback des BACS Programmers: Module 8-14 / Gesamtzahl 14 Batterien	
<p>As expected: ID's 8-14 are to be assigned. The programmer confirms your values, and sets the status to "started".</p>	<p>The status assumes that 7 modules have already been addressed. Therefore the process bar shows 7 as the last addressed module ID, and sets the status to "running".</p>

There are two basic stopp conditions:

1. All requested ID'S are assigned and the porcedure is completed.
2. By pressing the Stop Button



The ID's are assigned by pressing the button on the BACS modules. The module will acknowledge the receipt of the ID by the fast red flashing lamp slowly flashing green. At the same time the process bar in the web interface of the BACS Webmanager will count up one ID.

Note:

Ensure to press the button briefl and short. Do not keep it pressed permanently. As soon as you reach the pressure point of the button, release the pressure again immediately - pressing the button briefly is sufficient to carry out the addressing process. In case of the confirmation button is pressed for more than 2 seconds, the module switches into a special diagnostic mode and reject addressing attempts, and must be disconnected completely for about 20 seconds.

Acoustic feedback / onfirmation

On request, an acoustic confirmation can be set when assigning the BACS Module ID. By doing so, the BACS webmanager will generate an additional audio signal from every button operation.

Define different address ranges

In larger installations with a huge number of modules, addressing modules is still mandatory. To increase clarity, it may be recommended to assign ID's to the BACS modules step by step For this reason, you can address different address areas one after the other.

Just divide the BACS modules into individual address ranges:

Addressing sequence 1:	Address range 1-50,	Start-ID: 1 / Final ID 50
Addressing sequence 2:	Address range 51 – 100,	Start-ID: 51 / Final ID 100
Addressierungsdurchgang 3:	Address range 101 – 150,	Start-ID 101 / Final ID 150

Use the module addressing dialog Start and End to define a unique address range.

Note

The individual BACS modules can be combined in so-called strings - the modules are logically divided into individual groups and displayed and measured accordingly. This logical assignment works on this principle:

Number of registered modules divided by number of strings gives the number of modules per string.

When setting up the modules, make sure that the logical assignment matches the physical structure:

The order of the modules within a string are less important for the function of BACS, but if the modules' position differs physically and logically, measurement and control errors will occur. Due to a wrong construction, the strings can be randomly thrown together and lead into problems with battery string breakers, current sensors, etc.

Changing a single ID of a BACS module

The "Single" function allows you to set and change individual module IDs of BACS modules.

This function provides 3 different options:

- Switch an ID to another
- Switch an ID to 0
- Switch an ID from ID 0 to a target ID

The procedure is identical to all three options:

Under Old, enter the current ID that you want to change. Under New, enter the target ID to which you want to set the BACS module. Unlike standard addressing, this mode requires no action on site at the BACS module.

Single

Connect only one Module to the bus to avoid undetermined behaviour of the system.

Old

New

Set

Resetting module ID's

If necessary, the BACS modules can be returned individually or completely to the delivery state. Depending on the procedure, only the ID will be changed or by pressing the modules button for 20 seconds, the modules will perform a hardware reset and falls back to the default ID 0.

Resetting all modules or an address range to factory default

This action will reset all specified ID's directly to factory default 0 as soon as you press Start. The modules will visually confirm the reset with flashing slowly red.

Setting one single ID back to 0

ou can also use this method to specifically reset a BACS module to 0. As a consequence, the BACS module will slowly flash red. This is useful if you want to exchange a module, but want to reset it to the delivery state for later use within another installation. This way you make sure that the ID is no longer used before you remove the module.

Finding modules

Large BACS installations can be very confusing for new guys.

In order to locate a specific BACS module within all the strings, the programmer offers a fast and convenient solution:

Under Query you can optically flash individual modules with a red flashing. This will help you to find the according battery you wish to maintenance.

Module

Find all modules with the address to search. You will recognize them at the LED blinking red/green slowly.

Address

Show

Simply enter the ID of the module you are looking for and click on "Show" - the module will start blinking slowly red/green.

The module you are looking for will blink accordingly. You can choose between these two options

1. Go to the BACS module and press the button.

Pressing the confirmation button on the module itself will release the search function and the module falls back to normal operation mode.

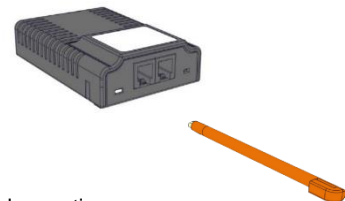

2. At BACS Webmanager, press OK to confirm search is over.

The module will be triggered by the BACS webmanager to fall back to normal operation.

Check for module with red/green blinking led. Address: 2 Acknowledge having found the module and quit search by clicking "Ok".

Ok

BACS programmer Single mode

The single mode is an option to program one single BACS module or change module ID's inside an existing BACS installation.

Please note for this function it is mandatory to know the exact ID of the according module you wish to program.

If you are unsure about the current ID, please reset the module to factory default ID 0. If you know the module's ID, you may skip resetting the module and use the current ID.

At „Old“, enter the current module ID. With „New“, the new module ID can be entered. Set will start the programming procedure. By doing so, it is not required to push the confirmation button at the BACS module.

The BACS module will confirm the setting by flashing slowly green.

Using single mode inside a BACS installation

This function can be used to change module ID's inside an existing BACS installation – this will allow to resort BACS-Modules according to the physical wiring. The according module can be logically set to a string it is physically installed. Please note: You can program two modules with the same address. As a consequence, BACS will not start because of an address conflict. If you set up two modules with the same address, you need to separate the ID's with a hard reset of one of these modules or by disconnecting on module. Otherwise, these modules will receive and confirm the new ID simultaneously.

Checking ID programming:

If you suspect that a module address has been assigned twice or a module is not responding as desired, this useful function allows to track down the modules:

At "module", enter the corresponding module ID and Display. The BACS Webmanager will automatically search for all modules with this ID. If the module has been found, it will start to flash alternating red and green until the confirmation button has been pressed.

track
press
search
found it

If you have assigned an address twice, both modules will flash accordingly. And, of course, if the BACS Webmanager will not be able to find the module, it will inform its user with an according message.

Duplicated ID assignment

If you accidentally assigned an ID twice during the exchange, you will notice during the test that two modules are flashing for one ID. In this case you can reset the wrongly addressed BACS module and reset it to ID 0 and repeat the ID assigning procedure.

BACS Error: HW Revision / Calibration error

Once all modules are set up correctly and the BACS programmer mode is disabled, the BACS system boots and initializes the modules according to their configuration.

The result can be observed within the BACS Monitor Screen: After validating the entire configuration, all modules will jump to "green" - The system will be ready for use.

In some rare cases, however, this system message occurs:

BACS

- Status: Charging
- Error HW Revision/Calibration mismatch

Please note that logfile timestamps require a timeserver.

String 1						String 2					
No.	Volt. [V]	Temp. [°C]	RI. [mΩ]	Equalize	Status	No.	Volt. [V]	Temp. [°C]	RI. [mΩ]	Equalize	Status
1	13.79	23.5	n.a.		●	3	13.79	21.0	n.a.		●
2	13.78	23.5	n.a.		●	4	13.84	25.1	n.a.		●
Σ Voltage 27.57 V						Σ Voltage 27.63 V					
13.79 [V] Target Voltage						13.81 [V] Target Voltage					

HW Revision Mismatch

On initialization, the BACS Webmanager assumes that the hardware revision for the module coming with ID 1 (The first module) is the reference for all subsequent modules. The Webmanager compares the hardware revisions with the revision number found at ID 1. If one of the following modules show different hardware revision, the module is marked accordingly:

BACS modules from different installations can be combined as required. After adjusting the ID of the according module, the module can be inserted e.g. as a spare part. Different hardware revisions are not allowed - they cannot be combined with each other. If a module does not fit the BACS system, it must be replaced by a corresponding module with a hardware revision that fits to it. In case of maintenance works inside larger BACS systems containing several BACS Web Managers, keep an eye on possible compatibility issues between the individual BACS modules

Note

If ALL modules show this issue on initialization but not the first module, take a look at the module with the hardware ID 1:

It is probably be affected and the following modules use the correct hardware revision.

In this case, exchange the ID 1 with a different ID via the BACS Programmer and repeat the boot process. Normally, all modules should now have the status green and this one module should be marked accordingly.

If you have just been supplied with a single BACS system, please contact your local dealer: It is possible that this shipment contains a wrong BACS module.

HW Calibration Mismatch

The second test validates if the modules are calibrated:

First of all: you cannot re-calibrate them manually. The calibration is performed during production at the factory. Because the BACS Webmanager needs exact values for its reliability, it checks if this calibration has been performed during initializing phase. If a module does not pass this test, it is not suitable for operation:

Unlike the Mismatch Error revision, the Calibration Mismatch Error is a hardware failure that affects the module itself. Unfortunately, this issue cannot be fixed by porting module to another BACS system:

In this case, the module must be replaced by a corresponding replacement module.

The alternative method: Using the BACS Programmer Windows software

The BACS Programmer software can be used with both, the BACS Webmanager budget as well as the BACS Kit. In addition to the core function of addressing modules and preparing them for operation, the BACS Programmer software also offers interesting features helpful for error diagnostic and the detection of individual modules within a very large installation.

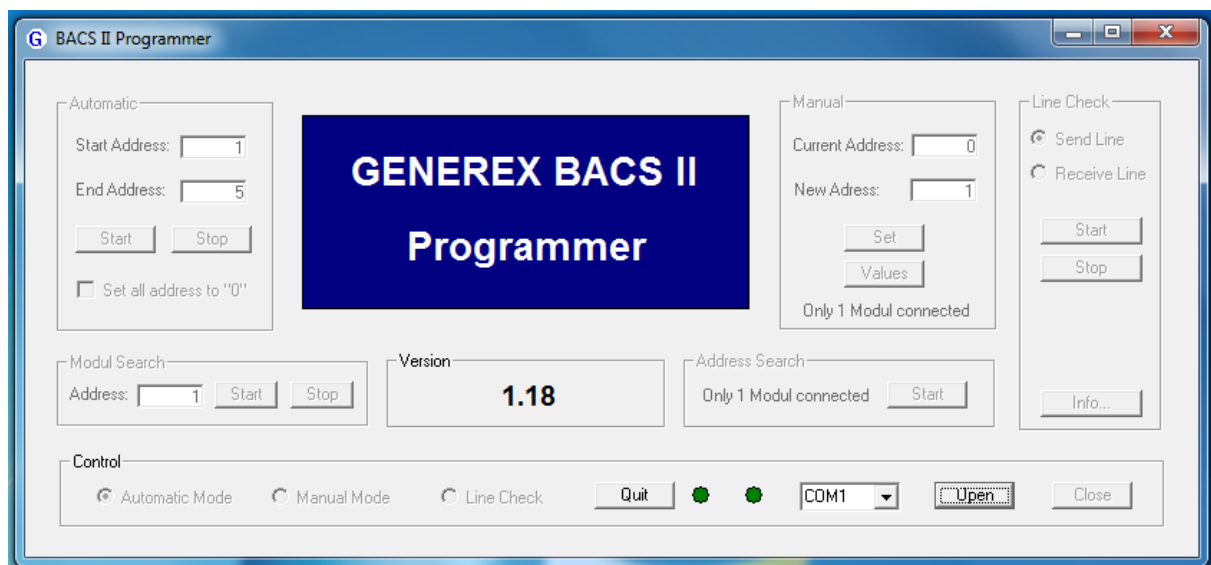

Preparation

This software is not a network software, you need to connect the BACS Bus Converter to the COM port of your computer.

Note

Modern laptops often do not provide a native COM port anymore. Before your on-site visit, check if your mobile device provides such a port. If this is not the case, a suitable adapter cable can be used. Normally, this cable will be connected to the USB port and thus establish a connection between your computer and the BACS Bus Converter.



This standardized accessory for your computer is usually available from specialist retailers.

Ensure to use the supplied cable, a standard cable may fit to the ports but may have internal differences - the software would consequently suggest problems caused by an inappropriate cable:

Not every Mini-DIN / Sub D 9 pin cable can be used to communicate with the BACS Bus Converter. Mark your cables to be used to avoid confusion during maintenance work.

Connecting the BACS Bus Converter

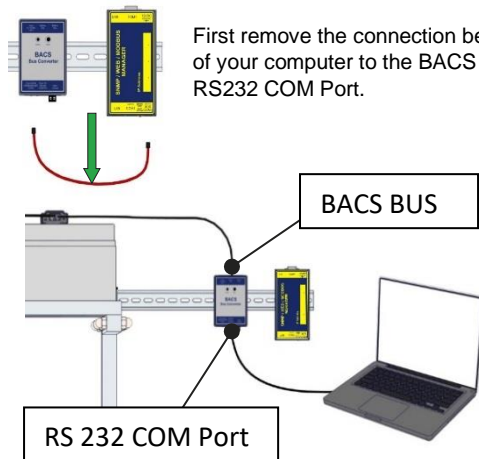

Note
 A BACS Bus Converter requires its own power adapter. A popular mistake is to forget this when connecting ... As a consequence, the BACS Programmer will not establish any communication.

Pay attention to possible redundancies when connecting.

You do not necessarily have to decouple the entire BACS system if you want to specifically check a specific section within a large system - but you need to ensure only one BACS Bus Converter will access the tested modules:

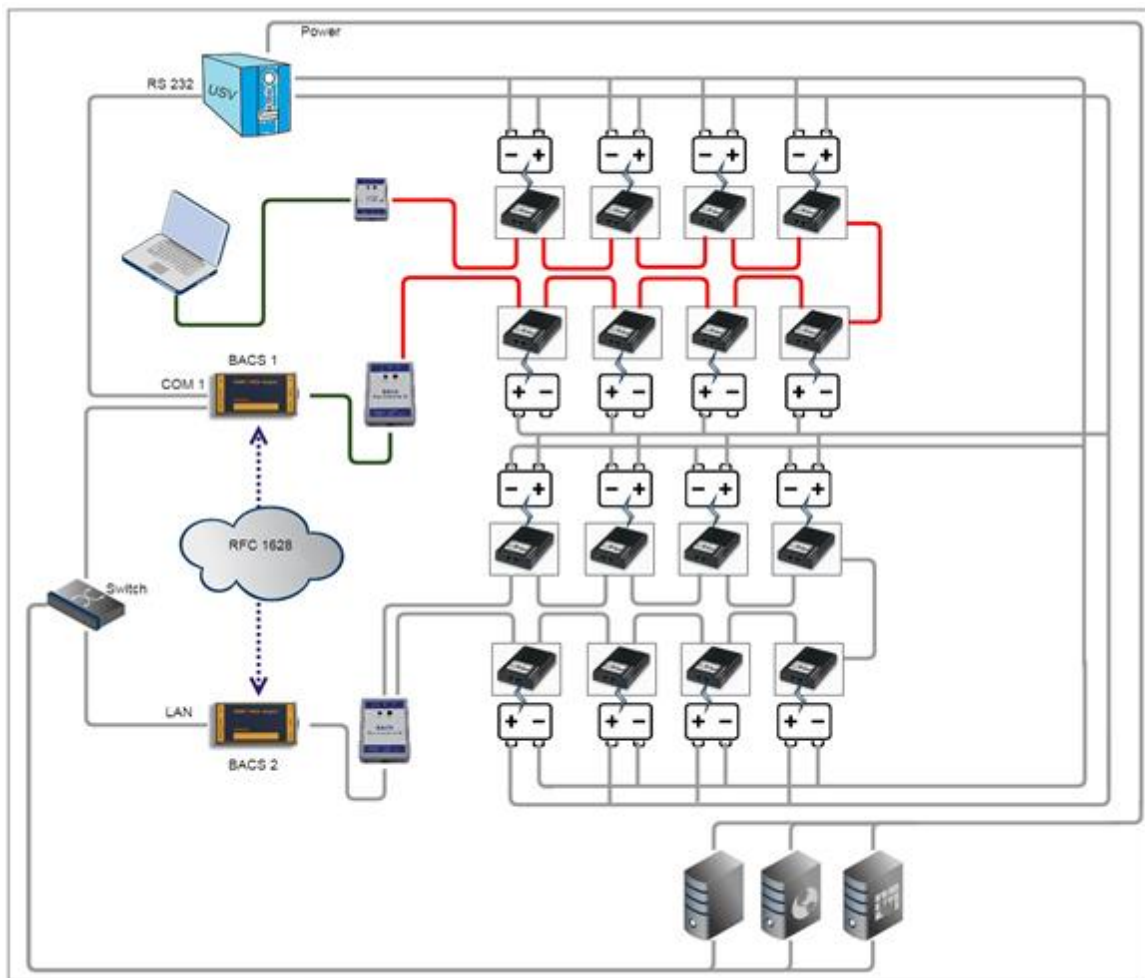

In this example, a cable was taken from the BACS 1 and connected via a BACS bus converter to the COM port of the laptop. In this constellation, both BACS bus converters would disturb each other until the segment to be tested is completely decoupled and separated:

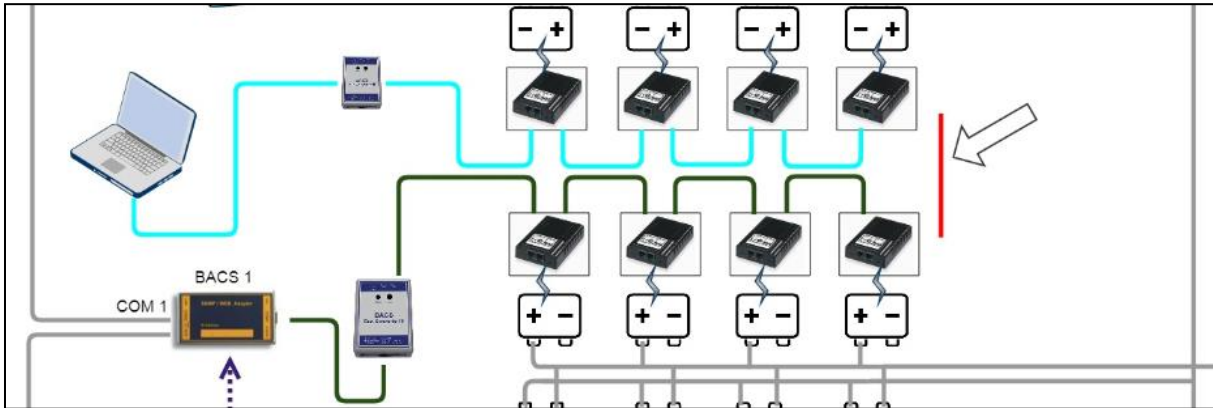

The number as well as the module ID's of BACS modules that can be tested is determined by the technician who interrupts the data connection.

Note

Wif you are looking for a fault in the cabling, you should check with both, a simple and a ring cabling. If several modules are affected in the middle, you can determine the source of the error exactly from both sides. This allow you to find the affected section. However, if there is only one cable faulty, you will need the simple wiring to locate the faulty cable or module.

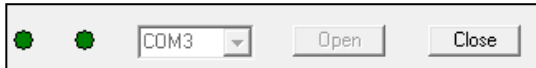

At BACS II Programmer Tool, select the according COM-Port of your Computer the cable is connected to and press Open.

The button label will change to "close" and the BACS Programmer will try to establish a connection to the BACS Bus Converter via the serial connection.

Toggle operating mode

Automatic Mode

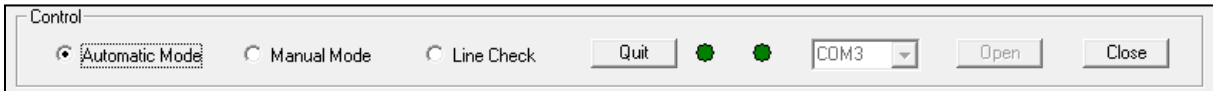

By default, the BACS Programmer starts in Automatic Mode.



In order to prevent accidental incorrect entries, only the functions assigned to a specific operating mode are enabled. The automatic mode is designed for the automatic addressing of BACS modules, the functionality is the same as in the BACS Webmanager

Manual Mode

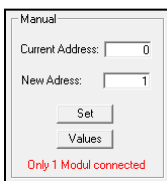
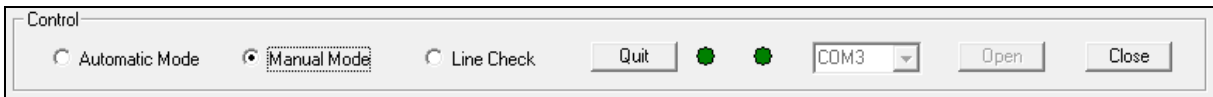

This mode describes similar functions like the single module address and search tools running on the BACS Webmanager. Search for an address ID of a single module or change module addresses.



Searching for an installed module

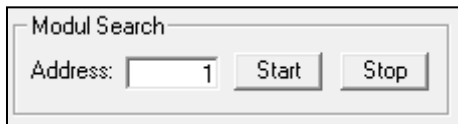

This feature will be interesting if you are inside a very large BACS installation and, as an example, you are looking for the BACS module with ID 378.

In this case, enter 378 and press Start. The requested module will respond with a red flash within the BACS installation until you click Stop.

Line Check

A premium feature of the BACS programming software is the Line Check:

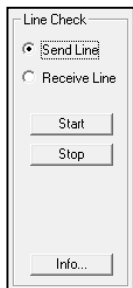
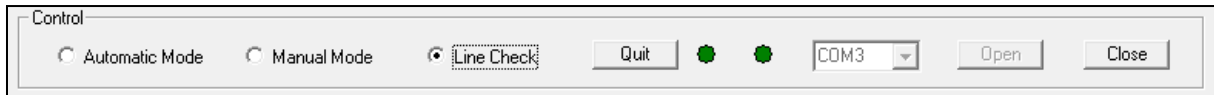

With the Line Check, BACS cabling can be tested.

This test can help you to find points of weakness inside a cabling concept. As an example, this test is helpful, if

- the signal is partial disturbed caused by electromagnetic interferences (EMI) or other influences during installation not all modules are addressable.
- All modules are addressable but not found during initial start up.
- sporadic communication lost occurs

Operation modes of the line check

The BACS Line Check offers two basic functional checks.

- Send Line Check
- Receive Line Check

Note
For the line check tool, it is mandatory that all modules are set to factory default ID 0.

How the send line test works

The Send Line Check is a test procedure in which all modules are addressed via a broad cast signal, starting from the BACS BUS Converter.

As soon as you start this test, the Send Line Check specifies a current state that the LEDs on the BACS modules should show:

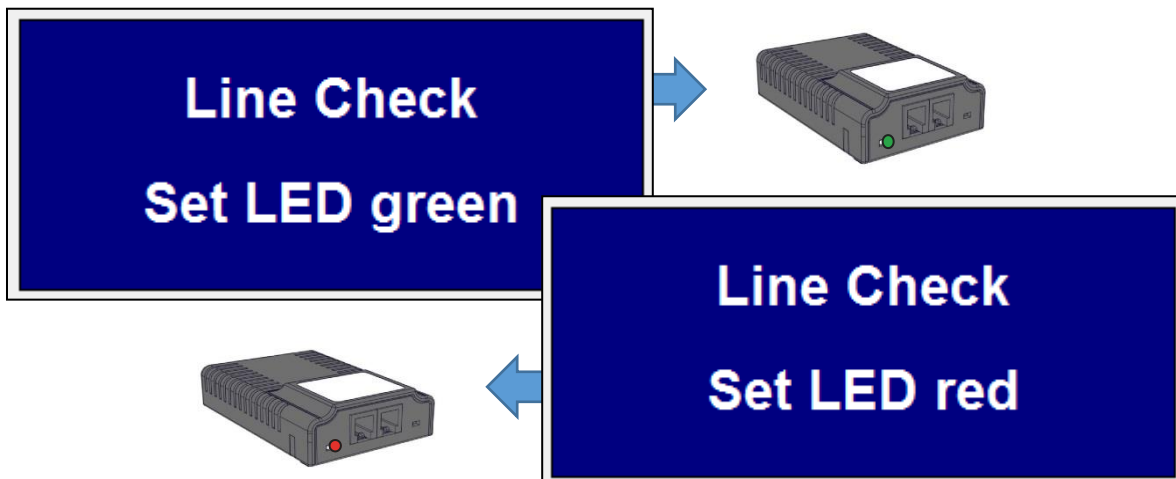

Modules that do not adhere to this guideline can be found easily. If several faults are found within a ring cabling, the outermost fault as well as a non-responding module chain is visible:

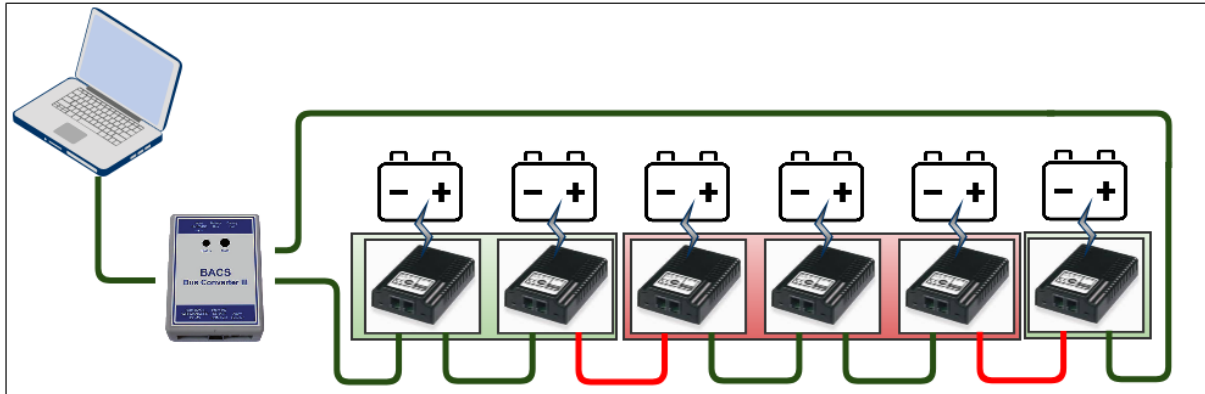

in this example, the red marked modules will show connection problems - everything between the broken cables will not be reachable. With this test, one can narrow down the sources of error, but do not clearly determine the reason for this problem. It may be...

- a broken cable
- a broken module port
- a broken port of the module before the error
- a broken module itself

The disadvantage of ring cabling while running this test, is the fact that a defective BACS module would immediately attract attention, but a single defective cable or a BACS module with a defective cable socket cannot appear. you need at least a completely broken module or two "half-broken" parts to find an issue:

By a single cabling defect, the redundancy behavior of the ring cabling would inevitably find all modules in the query.

What you can do

You can perform a redundancy test on known defects and determine a general availability of all modules. By contrast, the same test running on a simple wiring:

You would only reveal the first problem inside a BACS string.

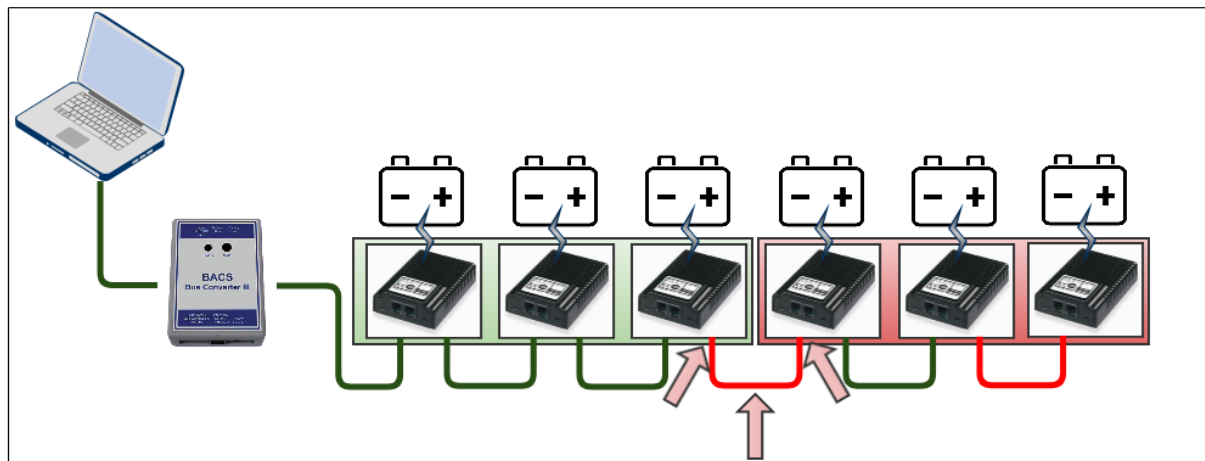

Again, you need to check whether the reason for the error can be found at the modules or the bus cables. This test reliably detects weaknesses inside an installation and will find all problems. The disadvantage is, you will always find only one problem after the other - this can take a long time.

Note

Both tests have their specific advantages and disadvantages. The send test coming with a ring cabling will show the general behavior and conveniently, but can only be used to find failures moderate system failures as well as broken single modules. The same test coming with a simple cabling method without a ring topology can then be used to find all problems but only the first issue in a row.

In combination, technicians can first ensure basic operations and guarantee basic availability.

The Receive Line Test

While the Send Line test will take care for general availability of modules and helps to find cabling issues, the Receive Line Test will take care for the quality of the data signal that will reach the BACS Bus Converter:

In some cases, the cabling is well done, but the communication does not start or interrupts sporadically. This may cause as an example by strong electromagnetic interferences: EMI – In this case, the signal itself will be compromised by electromagnetic fields that will harm the conductor inside the cable and produces error bits that cannot be compensated. With the receive line test, you can take a look what happens if the last module far away from the BACS Webmanager will send a data package.

Preconditions of the test

Please note that all modules must use the ID "0"! Otherwise this test will not work properly. If in doubt, use the Automatic Mode to set all modules to the ID "0" in advance. After resetting, proceed to the receive line test

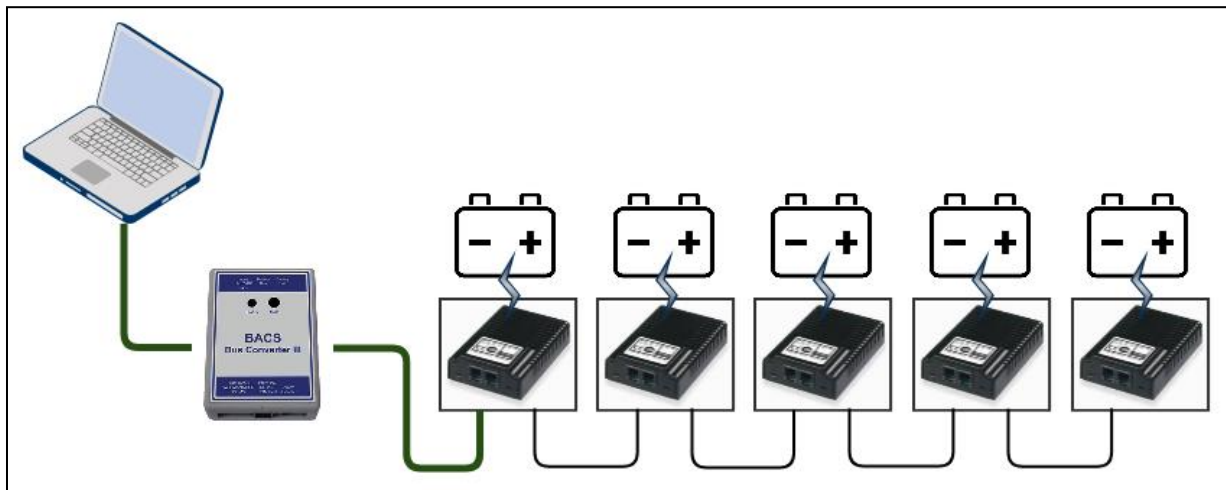

Starting the Receive Line test

Receive Line Check

The Receive Line Check is no longer supported by the BACS modules with software version 3.4.1. Before the test, please check which hardware revision of the BACS modules you are using. You will find the according label on the underside of the BACS modules.

Please note that you cannot mix different versions within one BACS bus.



The Receive Line Check can be used to check the quality of the data signal starting from the last module in the chain.

The receive line test is a passive testing mode. The BACS Programmer will not query but wait for a specially coded incoming data packet.

When you start the test, you will not see animations or something like that, BACS programmer will only show a blue center screen with white letters:

Performing a Receive Line Check

Because you want to know something about a specific route to the BACS programmer, this test will only run with a simple chain connection without any ring wiring.

1. To start the test, unplug the measuring cables to depower the BACS module.

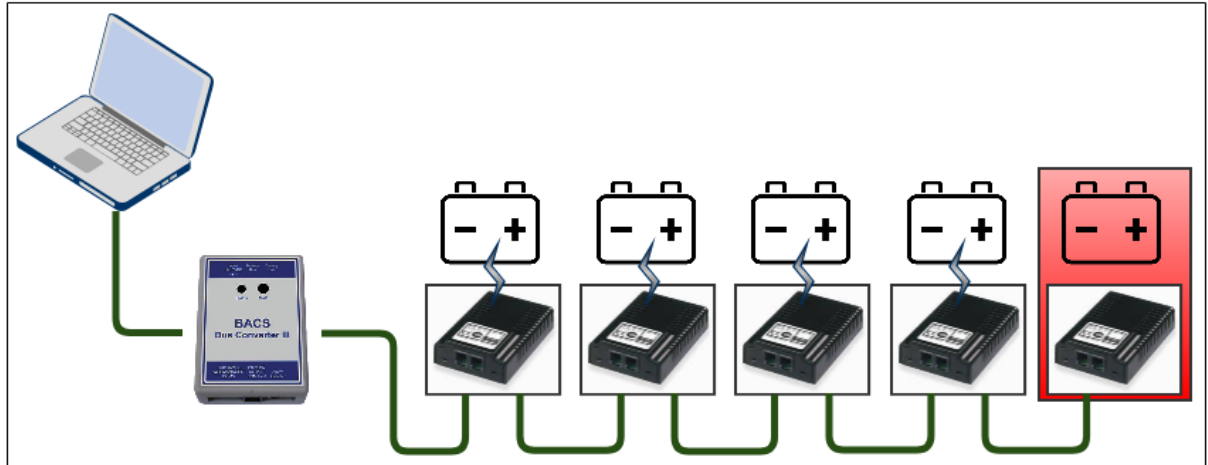
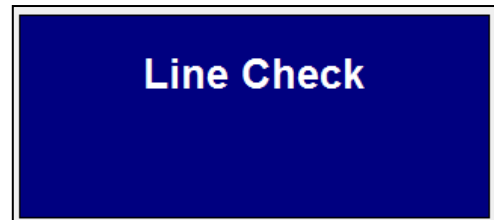

2. Press the button (yes dude, this is not the LED ...) and hold it.
3. Repower the module while holding the module button pressed.
4. Release the button. This will start the test.

What happens:

This BACS module will start sending 300 signed data through the cables to the BACS Webmanager or a BACS Bus Converter. This will be done sequential and evenly.

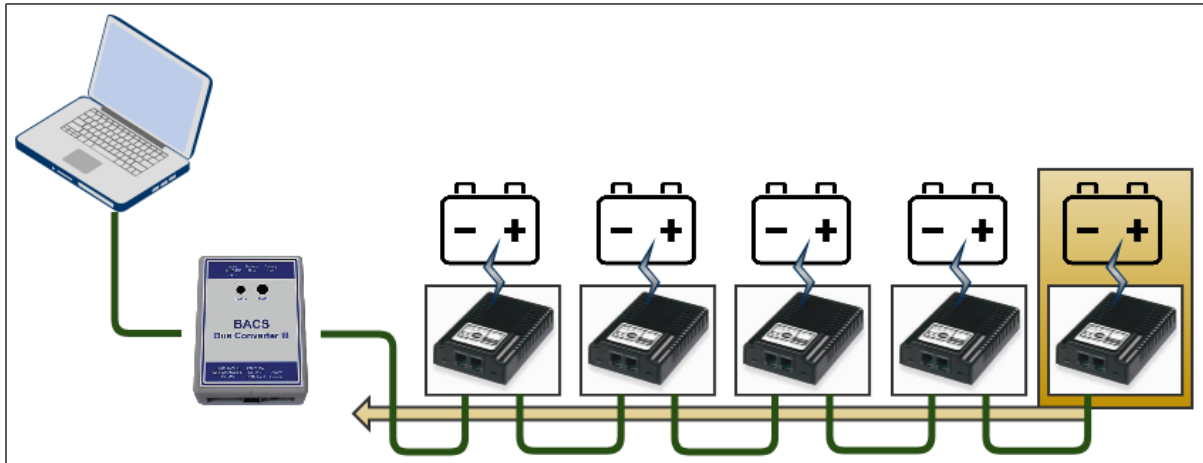

The BACS programmer will notice this incoming data packets and show the number signature:

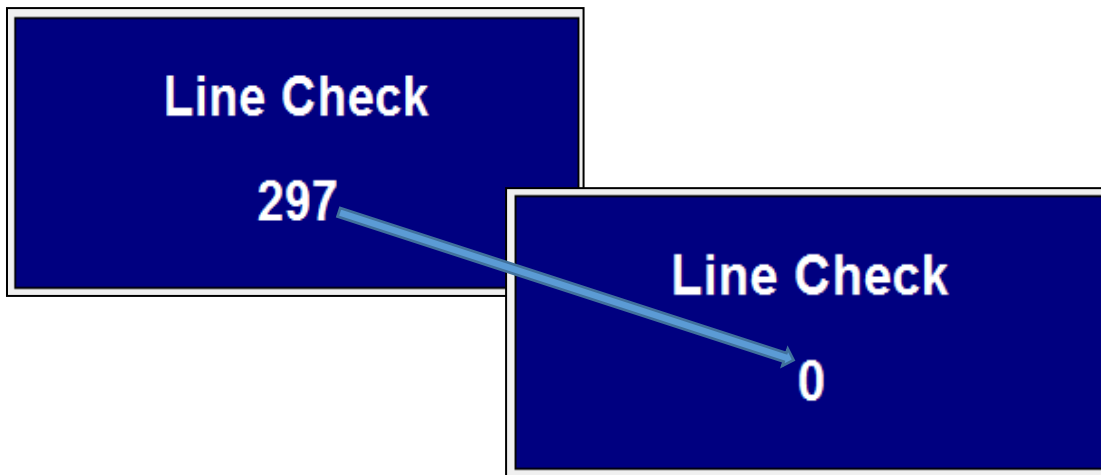

Due to the fact the data packages are signed with a unique number, it is possible to examine the quality of the data signal. In case the data packet is broken or invalid, it will be rejected.

Due to the fact you will notice following:

- The counter does not start, the screen is blank

In this case, no incoming data packets are noticed. If the send line test works as expected, please check if all modules are at default ID 0. Most common problem: Starting this test is a little bit tricky – you need to hold the button while inserting the measuring cables to repower the module. When you release the button, the test starts. If the test does not start, you cannot receive data packets.

- Jumping numbers

Yes, the test started and the last module inside the chain sends his 300 data packets. In this case there are missing or broken data packets. These packets are lost and will show, in general it may work but there is something wrong inside the cabling. To find the reason why, you may split the bac modules in two different strings and repeat the test until all numbers will be shown evenly.

- It starts counting evenly, but it suddenly stops.

This means, the chain is interrupted physically or something will block all data packets.

- It runs as expected

The numbers will be shown evenly and the countdown starts at 299 and stops with 0. Data quality is OK, all modules will respond.

Since the data packages are signed, a fault in the data line can be diagnosed very quickly because the display window counts irregularly or displays jumping numbers. If the meter stops at a number, it can be assumed that the data connection has collapsed.

Note

This test starts only if the trigger timing on the last BACS module is consistent. If the test does not start, first make sure that the test was triggered correctly. Otherwise, the Receive Line Check will indicate a fault in the BACS cabling.

BACS Reader

The BACS Reader is another tool to collect a bunch of interesting information about your current BACS installation. Like the BACS Programmer, the BACS Reader is started on a Windows PC and can then be connected to a BACS-BUS Converter or the Service Port of the BACS Webmanager via a COM-Port..

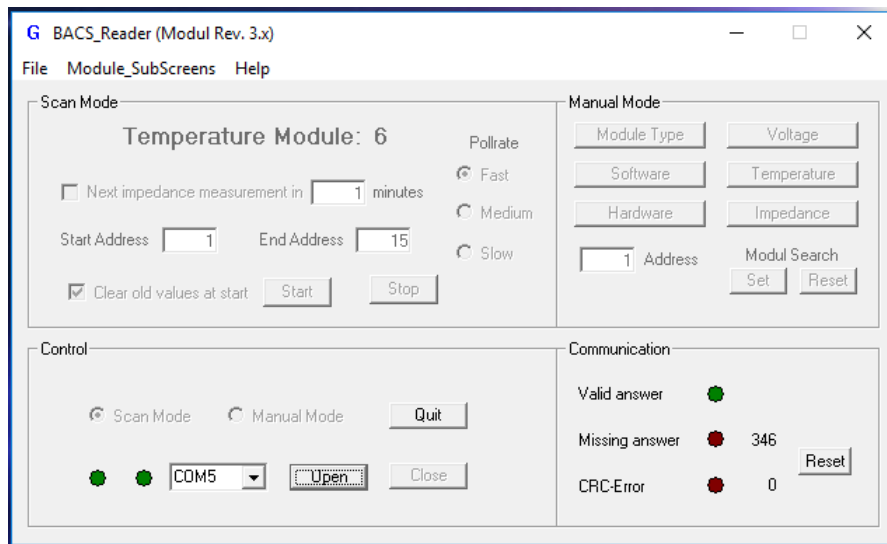

While the BACS Programmer is used for assigning ID's and to provide options for the control of the wiring and the quality of the signal, the BACS Reader can read the modules itself after successful installation and provide valuable information about the condition of the batteries.

Opening the COM connection:

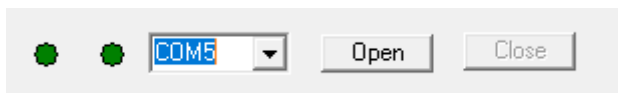

First, select a free COM port and connect the BACS system. Please take care that all connections has to be disconnected first, if you are using a BACS BUS Converter. If you are using the BACS Webmanager in parallel to your own BACS Bus Converter, please disconnect the BACS Webmanager from the modules and connect the BACS BUS Converter instead.

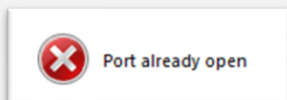
Tipp:

If the port is in use, you will receive a corresponding error message will be displayed. In this case, choose another COM port or close the application that is currently using the COM port.

Once the connection is established, you can choose between different modes:

Scan Mode

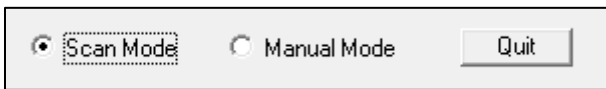

While the scan mode systematically queries all modules one after the other, you can obtain specific information about a module in the manual mode..

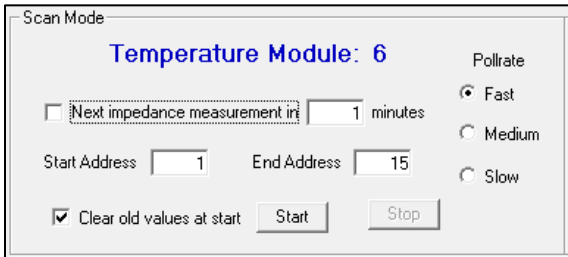

Start / End Address

Define which ID number range for the read out. You can automatically

- Read out a single module
 - Set Start / End Address to the Same ID
- Read out all modules
 - Start ID = 1 and End ID = last module ID
- Read out a specific range
 - e.g. Start is 35 and the end ID 64

Start ID = 35 and End ID = 65

Polling rate

The modules are actively addressed and queried individually. In very large installations, a too fast polling rate can lead to the modules not having had enough time to send a valid answer. Since the BACS reader does not distinguish between a too fast polling rate and an actual missing answer, this will generate very high values very quickly under "Missing Answer". In this case, lower the query rate and repeat the process

Clear old values at Start

Normally, the old values remain in the predefined fields and are updated accordingly. Under certain circumstances, this can be confusing, as it is not entirely clear whether the value is now current or not. With this function, the values are removed and re-entered at each start-up.

GX_R_AUX

The GX_R_AUX is the digital BACS version of the former CON_R_AUX, which can be connected directly to the CS141. The configuration process is similar, but the GX_R_AUX provides some advantages like the option to integrate 8 of these devices into one BACS bus - this will allow up to 32 inputs and outputs in total. Due to the fact they are freely configurable, that can be used to switch and monitor many functions including other systems. The GX_R_AUX devices are designed to be used as modular. They do not need to be installed all together at a single place - Install or move them during maintenance work anywhere within the installation inside the BACS bus. Since the GX_R_AUX is supplied with the necessary operating voltage via the BACS bus cabling, there are no further live cables that need to be installed separately.

The GX_R_AUX is an optional accessory which, thanks to the modular concept, expands the range of functions and actions of your BACS installation by many additional options.

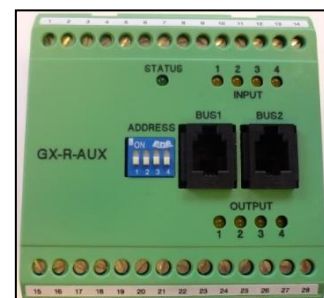

Note

The GX_R_AUX makes it possible to configure battery systems according to the US standard "International Fire Code IFC 608.3". This standard defines, in case of a malfunction in coming with a possible impending Thermal Runaway threat, the batteries have to be completely isolated automatically. The use of the GX_R_AUX allows activation of battery separators and thus meets the requirements of the US Standard International Fire Code IFC 608.3. In case of an impending Thermal Runaway, the GX_R_AUX can trigger battery separators or send an opening signal through alarm contacts in order to disconnect the battery system from the charger so the batteries cannot heat up anymore.

Connectors

Screwed Connections 1-14:

Ports 1-14 are located on the side marked as input. Port 1 is located on the left side when viewed directly from above.



Screw terminal layout pins 1 - 14

1. Reserved for future developments.
2. Reserved for future developments
3. Digital Input 1
4. +12V (voltage for input 1)
5. Digital Input 2
6. +12V (voltage for input 2)
7. Digit input 3
8. +12V (voltage for input 3)
9. Digital input 4
10. +12V (Versorgung für Eingang 4)
11. Alternative BACS bus +12V voltage
12. Alternative BACS bus data input
13. Alternative BACS bus data output
14. Alternative BACS bus ground

Pin 11 – 14: Alternative BACS Bus

In some cases, it may be necessary to connect BACS devices directly via contacts. To provide this additional function, ports 11 to 14 can be used in case of the device is not connected to the BACS bus via the "BUS 1" or "BUS 2" plug.

Center console

The address switch: The DIP bank "Address"



In contrast to the BACS modules, the GX_R_AUX must be configured to its own ID. This will be done via the DIP switches.

The following DIP settings are valid:

DIP 1	DIP 2	DIP 3	DIP 4	GX_R_AUX ID setting
off	off	off	off	1
ON	off	off	of	2
off	ON	off	off	3
ON	ON	off	off	4
off	off	ON	off	5
ON	off	ON	off	6
off	ON	ON	off	7
ON	ON	ON	off	8
off	off	off	ON	9
ON	off	off	ON	10

Please note that the ID, like a BACS module, requires a unique ID, which must be set consecutively starting with ID 1. The difference to the BACS module is that the GX_R_AUX ID is set directly via the DIP bank and can not be managed via the BACS Web Manager - whereby the base address range used differs from the BACS modules.

Therefore, the BACS module with the ID 1 cannot be confused with the GX_R_AUX ID 1.

Connecting the GX_R_AUX to the BACS Bus

The GX_R_AUX can be used everywhere inside a BACS bus - Simply connect the module between two BACS modules. The GX_R_AUX fits seamlessly into the BACS bus and can be used immediately.

Output connectors

Screwed connectors 15-28

The ports 15-28 are on the side marked as output. Terminal 15 is in direct view from the top on the left side, in opposition to input 1.



Screwed connectors 15 - 28

- 15. Relay contact 1 NO*
- 16. Relay contact 1 NC**
- 17. Relay contact 1 Common
- 18. Relay contact 2 NO*
- 19. Relay contact 2 NC**
- 20. Relay contact 2 Common
- 21. Relay contact 3 NO*
- 22. Relay contact 3 NC**
- 23. Relay contact 3 Common
- 24. Relay contact 4 NO*
- 25. Relay contact 4 NC**
- 26. Relay contact 4 Common
- 27. Relay contact zukünftige Entwicklungen
- 28. Relay contact zukünftige Entwicklungen

*NO: normally open contact

**NC: normally closed contact

Note

If the labels and labels have been removed, you can still clearly identify the numbering of the screw terminals based on the position of the LEDs: On one side you have 5 LEDs - 4 grouped and one separated. The separate LED is the status indicator.

Align the GX_R_AUX in a way that the 5 LED's are in the upper side.

From now, you can easily numerate the terminals you are looking for:

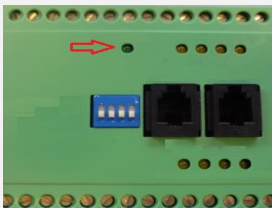

The upper screw bar is numbered from left to right in ascending order, the first connection on the left outside defines 1. Furthermore, the upper bar defines the input bar.

The DIP switches are numbered from left to right in this orientation, from left to right: 1, 2, 3, 4

The bottom screw bar starts on the left side with the number 15 and is incremented to the right continuously. the bottom screw bar defines the outputs

GX_R_AUX Configuration guide

For this configuration step, navigate to the following menus:

This configuration example is based on 4 configured GX_R_AUX devices

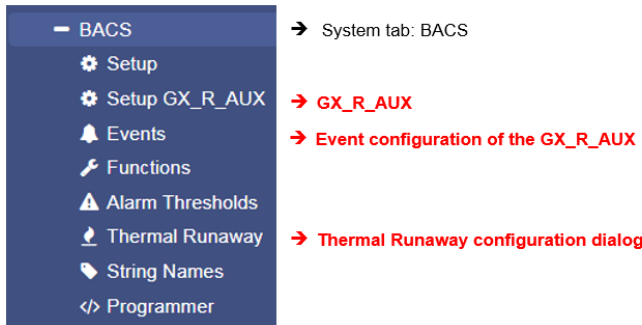

Step 1 - Setting up a mandatory GX_R_AUX ID

Set up a corresponding ID - the ID's you choose hast to start with 1 and ends with a number according to the number of GX_R_AUX you wish to use. Please note the following conditions:

- An ID may only be assigned once
- The first device receives the ID 1, then it is consecutively numbered
- Do not use more than the maximum of 4 GX_R_AUX within one BACS installation.

Step 2 - At BACS Webmanager, open the GX_R_AUX configuration dialog

In the configuration dialog, you can use the BACS Webmanager to specify the number of installed modules:

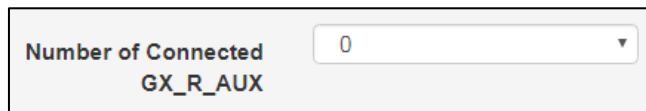

Enter "0" to disable the function. Otherwise, set the number of used GX_R_AUX modules and click Apply. Due to the fact new devices have been added to the BACS bus, the web manager must reboot BACS to find and initialize the new devices accordingly. This procedure will only restart required services, neither the Webmanager itself nor the UPS will reboot.

Note

The BACS Webmanager will program the ID of a GX_R_AUX - the ID will be set by the DIP switch bank. After setting up the hardware ID of the GX_R_AUX, the Webmanager will be configured to search for the specific number of GX_R_AUX that are placed inside the BACS installation. If the estimated number of GX_R_AUX is not found, a corresponding error message will occur.

You can follow the success of the initialization in the upper task bar.

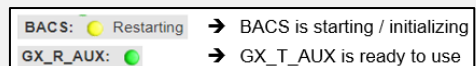

How to set up the outputs of a GX_R_AUX as battery breaker

Under Thermal Runaway, activate the battery breaker functionality

Before configuring the GX_R_AUX outputs and associated events, you need to decide if and how many battery breakers you need. Open the Thermal Runaway configuration dialog - the battery breaker configuration is mostly done automatically, which manifests itself in subsequent configurations:

1. According outputs will be labeled automatically
2. Events and jobs assigned to a Thermal Runaway are automatically entered

The total number of required battery breaker depends on the number of strings you configured at BACS general setup.

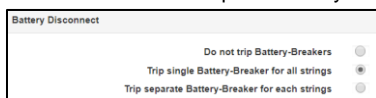

If you want to use one battery breaker for the complete installation, select the option *Trip single Battery-Breaker for all strings* “.

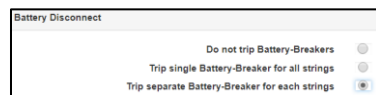

If you want to use a single battery breaker for each string installed in your BACS System, select the option „Trip separate Battery-Breaker for each string

Press *Apply* when ready.

Under Setup GX_R_AUX, you will find new entries:

Output	Name	NC Contact
1	Trip Battery-Breaker String 1	<input type="checkbox"/>
2	Trip Battery-Breaker String 2	<input type="checkbox"/>
3	Trip Battery-Breaker String 3	<input type="checkbox"/>
4		<input type="checkbox"/>

As you can see, BACS auto-labeled your GX_R_AUX Outputs according to your settings. You cannot re-label them - they are reserved for the battery breakers. Please note: If you use battery breaker, ensure, the NC Contact Flag is not set!

Again, press Apply when ready

How the BACS Webmanager will count the battery breaker:

The first battery breaker will be associated with output 1. From there onwards, all battery breaker will be counted one by one. If several AUX are in use, the 5th battery interrupter is configured on the 2nd AUX, Port 1. The classification as battery breaker will exclude any existing configuration - the configured output can only be used for the according battery breaker. Furthermore, depending on the number of GX_R_AUX devices, an individually configured additional configuration dialog will appear:

Name the inputs and outputs in free text. These labels can be found next to the inputs and outputs at the GX_R_AUX - Monitor:

GX_R_AUX Status					
GX_R_AUX 1					
Input	Name	Status	Output	Name	Status
1	test	●	1	Trip Battery-Breaker String 1	● <input type="button" value="Switch On"/>
2		●	2	Trip Battery-Breaker String 2	● <input type="button" value="Switch On"/>
3		●	3	Trip Battery-Breaker String 3	● <input type="button" value="Switch On"/>
4		●	4		● <input type="button" value="Switch On"/>

Normally Open / Normally Closed

If you do not use battery breaker you may use the outputs freely. Depending on your settings, the behavior of the BACS Webmanager changes when dealing with contacts:

NC / NO input configuration

The inputs provide to connect any potential-free switch contacts. It can be distinguished whether a contact must normally be closed (NC) or open (NO). By Changing from NO to NC behavior, it is possible to harmonize the contacts to third party devices.

A switching state in opposition to the configuration is provided with a red alarm marker:

Input	Name	NC Contact
1	climate control running	<input checked="" type="checkbox"/>

Setup dialog of GX_R_AUX ...

Input	Name	Status
1	climate control running	●

BACS GX_R_AUX monitor

In this case, the climate control will close the contact if running. Otherwise the Status is marked red – the climate control is off.

NC / NO output configuration

The outputs can be assigned via the terminal strips 15-26. This option defines if a contact is generally closed and needs to be opened or open and has to be closed. During the BACS initialization, the switches automatically take the correspondingly configured switching states.

Please note:

A NO - normally open - contact is open at system startup and **must be closed /turned on** accordingly:

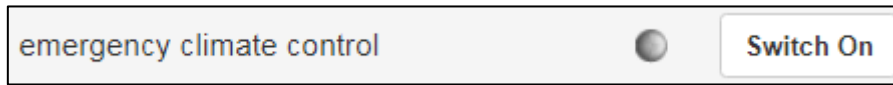

An NC - normally closed - contact is closed at start up and **must be switched to off / open** accordingly



Depending on the configuration, the marker is green (active) or grey (disabled).

Defining jobs to GX_R_AUX input events

BACS use a stand-alone event and job management.

This allows to use a BACS system completely without a UPS connection in stand-alone operation and use its own sensors.

To define a job, open the events menu in the BACS configuration menu and search for the following entry:

>	<input type="checkbox"/>	+	<input type="checkbox"/>	BACS GX_R_AUX 1 Input 1 Alarm Off	3	1	0	1	0
>	<input type="checkbox"/>	+	<input type="checkbox"/>	BACS GX_R_AUX 1 Input 1 Alarm	3	1	0	1	0
>	<input type="checkbox"/>	+	<input type="checkbox"/>	BACS GX_R_AUX 1 Input 2 Alarm Off	3	1	0	1	0
>	<input type="checkbox"/>	+	<input type="checkbox"/>	BACS GX_R_AUX 1 Input 2 Alarm	3	1	0	1	0

BACS GX_R_AUX 1 defines the module assigned with the ID 1 via the DIP bank. If you have more modules in use, they will be listed automatically as AUX 2, AUX 3, and AUX 4 inside the event menu.

The current alarm ON/Off state will be determined by NO / NC contacts definition at GX_R_AUX setup. At the event handling, it is possible to configure what will happen at the current contact state.

Note

The word "alarm" itself is relative meaning in this context. You can also communicate with other devices through the inputs and, for example, get switching confirmations - you are not forced to use this as an "alarm" notification.

Setting up a job

In this example, a log entry job is set to Input Port 1.

To enter a new job, select **+** at Input 1 Alarm – this will open the job configuration dialog:

1. As Job, choose „Log “:

With the job type, the parameters will be adapted automatically. In this case, you can type a free text messages that will appear at the event log if GX_R_AUX 1 input port 1 reports a closed alarm contact position:

Timing will allow to define when this job shall be executed. In this case, the job is executed once, at the precise moment when the defined alarm behavior occurs. For more information, please refer to the chapter event handling at part 1 of this manual.

Timing

Immediately, once

After seconds

After seconds, repeat all seconds

After seconds on Battery

At seconds remaining time

With save, the job will be written to the configuration file and executed as soon as the according event occurs. You do not need to restart the CS141 / BACS Webmanager.

Checking the job configuration:

To test the job, unfold the event *BACS GX_R_AUX 1 Input 1 Alarm* by clicking



Your new job will be displayed:

<input type="text"/> <input type="text"/> <input type="text"/>	Log	Einmal, sofort	{"text": "An Input 1 wurde der Kontakt geschlossen!"}
--	-----	----------------	---

At this menu, you can edit, delete or test the job. More information can be found at event handling configuration in part 1 of this manual.

Communicate with third party devices via GX_R_AUX outputs

In this example, a third-party monitoring device shall be triggered by AUX output port 1.

1. Choose the event that shall trigger the output and press **+** to start the job configuration dialog
2. As job, choose AUX:

Job AUX ▼

Depending on the number of installed GX_R_AUX modules, you can select an individual port from the list: In this example, GX_R_AUX 1, Port 3 is selected.

By doing so, use at GX_R_AUX output screw bar these screw connectors:

- 21 Relay contact 3 NO*
- 22 Relay contact 3 NC**
- 23 Relay contact Common

The wiring method determines what will happen in case of the command „Set High (On) “:

- | | |
|---------------|--|
| NO <-> Common | On trigger, the contact will be closed |
| NC <-> Common | On trigger, the contact will be opened |

The standard configuration for these contacts is NO <-> Common. For this example, Port 3 will be closed as soon as the according event will occur.

Parameter

Port Number GX_R_AUX 1, Port 3 ▼

Command Set High (On) ▼

Timing will allow to define when this job shall be executed. In this case, the job is executed once, at the precise moment when the defined alarm behavior occurs. For more information, please refer to the chapter for advanced event handling at part 1 of this manual.

Timing

Immediately, once

After seconds

After seconds, repeat all seconds

After seconds on Battery







At seconds remaining time

With save, the job will be written to the configuration file and executed as soon as the according event occurs. You do not need to restart the CS141 / BACS Webmanager.

Checking the job configuration:

At the according event, click  to unfold the job list configured to this event:

The new job should be added accordingly:

			Log	Einmal, sofort	{"text":"BACS started"}
			AUX	Einmal, sofort	{"port":"102","on_off":"1","text":"BACS started"}

From here, you can edit, delete and test the job. Results can be seen at the GX_R_AUX monitor as well as event chains may be triggered.

Note

For the complete description of event handling including all symbols, please refer to page 58 of this manual, chapter:

System event handling

BACS Functions

For this configuration step, navigate to the following menu:

- BACS
- ⚙️ Setup
- ⚙️ Setup GX_R_AUX
- 🔔 Events
- 🔧 Functions
- ⚠️ Alarm Thresholds
- 🔥 Thermal Runaway
- 🔤 String Names
- </> Programmer

➔ System tab: BACS

➔ **BACS Functions menu**

Each BACS Webmanager offers basic functions that can be switched on or off remotely via the web interface.

BACS Buzzer

This internal alarm provides a clear audible warning signal as soon as there is a problem with your BACS system or the connected sensors occurs or in the case of a so-called General Alarm.

As a default, the buzzer will be triggered in case of the event „BACS General Alarm “.

BACS Buzzer

BACS Relay

Parallel to the alarm buzzer, BACS provide an internal relay:

With this relay external monitoring systems can be informed that something went wrong. The internal BACS alarm relay is linked to a general alarm and cannot be configured:

The relay is a pre-defined normally closed contact, which automatically picks up about 15-20 seconds after system startup and is only reopened in case of a system fault:

1. A BACS General Alarm is in progress
2. The BACS Webmanager or BACS Bus Converter is depowered.



Master alarm will start, if ...

- Voltage alarm high/low,
- Temperature alarm high/low
- Impedance alarm high/low
- Communication lost to one or more modules or a system alarm is in progress
- Thermal Runaway alarm
- Equalizing / Balancing Error alarm
- String voltage alarm

Note:

If you manually open the relay, it remains open until one of the following conditions is met:

- The device restarts (by rebooting via software button or in case of a cold boot).
- An active BACS-alarm falls back to normal state (voltage measurements reach alarm levels and drops below).
- It will be closed via BACS relais functions menu.

Discharge Counter Reset

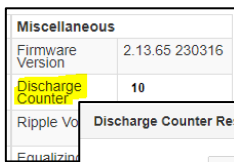

The Discharge Timer shows provides information about the number of confirmed discharges a battery system has experienced - this counter can hold valuable information about the life cycle of a battery as well as maintenance interval. The Discharge Counter also provides information about the quality of a main power supply.

The Discharge Counter also provides statistical information about the quality of a main power supply, as it naturally also logs the number of power failures or voltage dips.

The Reset button will reset the overall number of discharges.

BACS alarm thresholds

In principle, there are two points during usage, that may heavily damage the batteries of a UPS system:

Overvoltaged batteries

The overvoltage occurs if a UPS initiates a boost charging cycle to restore emergency power time as fast as possible after a discharge. As an example, the charging process will be done with a boost charge or operates with predefined charging voltage.

In both cases, the reference charging point is the slowest loading battery to rule the entire charging process.

As result, normal or fast charging batteries are consequently overcharged, leading into average temperature issues and as a long-term consequence, overcharging the cells in the battery are damaged through the dehydration process coming with abnormal temperature usage. Overcharging will damage the battery, but this is not enough:

As a consequence of an overcharge, a battery will heat - this may lead into a dangerous battery overheating and fire issue. Conversely, a battery damaged by overvoltage can subsequently not meet the requirements set, which leads to different behavioral characteristics:

- Extended loading time
- Permanently performance decrease
- Temperature increasing with each charge/discharge cycle
- Sporadically dropping below the discharge end voltage
- Lapsing service time
- Overheating and acute fire hazard.

Which defects occur exactly depends on the type of battery as well as the basic conditions. Overloading should, if possible, be avoided for these reasons.

Deep discharge

During deep discharge, a cell of a battery is discharged during use until a complete depletion. In case of a deep discharge, the voltage drops below the final discharge voltage, a condition in which a wide variety of defects may occur. Depending on the type of battery even a single deep discharge can damage the battery internally so that it can lead into a total failure or even a polarity reversal of the battery contacts.

Reloading damaged battery can be very dangerous because the reaction to the charging current unpredictable:

Although the battery is faulty, it initially appears to be responding normally to the charging process initiated by the UPS - a creeping malfunction can appear up to 16 hours after charging is complete. Everything may happen, starting at an acute overheating when starting or during charging process as well as a seemingly sporadic phenomenon during charging that leads creeping into a fire issue many hours later.

Note

Typically, a UPS will stop operating in time to avoid this deep discharge, but overvoltage or undervoltage that weaken the cells, cannot be detected the UPS.

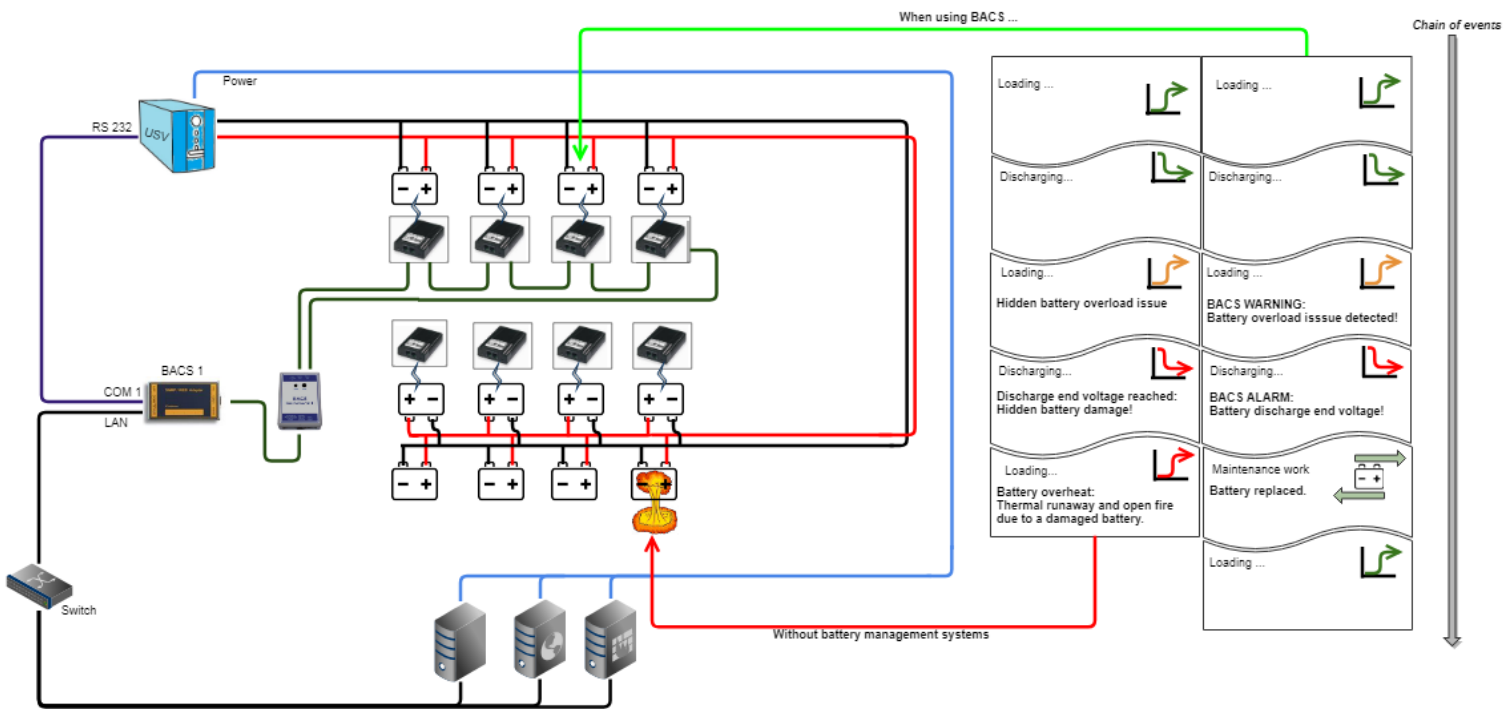

Threshold definition

For this configuration step you need the following menu:

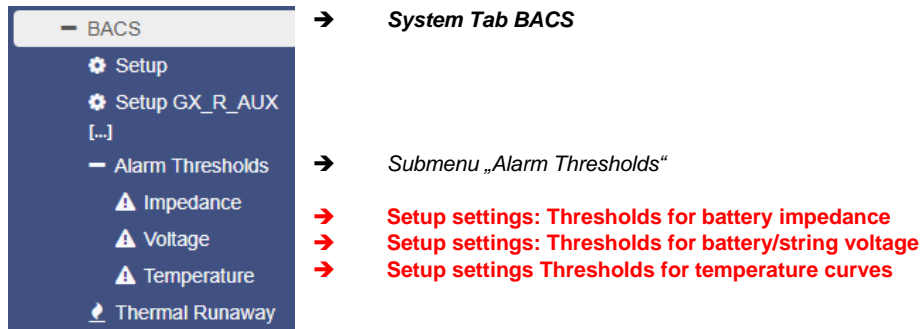

The thresholds define fixed points within the charge / discharge cycle at which intervention becomes necessary before an acute problem arises.

The following values are monitored during both the discharge / charge cycle:

Inner resistance

The design of a battery has a great influence on the internal resistance - in some cases it rises suddenly, in others it drops suddenly. Here, the measured value is determined by its carrier material - the battery type. In new batteries, the measured internal resistance should always be the same. Deviations in measurements of internal resistance indicate a battery fault or battery aging.

The voltage is not practical as an indicator of battery failure, because the measured voltages at the battery follow the voltage behaviour of the charger during trickle charging. The voltage fluctuations here can vary so hard, that no statement can be made about the condition of a battery. Due to the internal resistance (and the equalising indicator), the measured values indicate a problem within the battery chemistry and thus indicate a warning that a battery failure could occur in the near future. The measured internal resistance of a battery is therefore the better option for long-term monitoring - it allows reliable forecasts to plan maintenance windows.

For warning levels, we recommend a deviation of 25% from the average value of all batteries.

For alarm levels, we recommend a deviation of 50% from the average value of all batteries.

Note:

The impedance measurement values from the battery manufacturer's data sheet are not always suitable to be used as a basis for the threshold values for BACS: The reason is the different measuring method of the battery manufacturer for the impedance value. Please determine the threshold values for BACS using the procedure described in the manual.

Voltage

The voltage that a battery is measured during the charge/discharge cycle indicates whether the battery will soon be overcharged or deeply discharged. If this value exceeds or falls below the permissible specifications for the battery, a corresponding warning is issued. The limits set by the BACS system are correct for most batteries and should only be changed to a greater extent after consultation with the battery manufacturer.

Temperature

With the operating temperature, huge variety on the performance and life of a battery arises. A battery will heat up during the charge and discharge cycle. However, if the internal and environmental operating temperature exceeds limits for the battery design, defects may occur and harm the entire system. The defect ranges from less efficiency up to a total sudden death.

Thresholds: The menus in detail

Impedance

For this configuration step, you need the following menu:

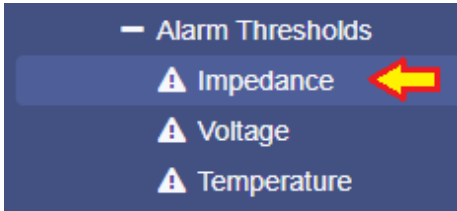

The type selection

BACS can be adapted to different operating scenarios - Depending on the setting, the general view on the impedance values of the connected batteries changes. At least one of these options must be activated, but several options can also be combined:

Dynamic	<input checked="" type="checkbox"/>
Static	<input type="checkbox"/>
Baseline	<input type="checkbox"/>

- Dynamic

With this setting, BACS automatically measures the internal resistance of each battery and compares the measurements with each other. If individual batteries deviate from the set value by a configured percentage, a warning or alarm is issued. Since the average of all batteries is taken as a basis, the alarm limits change fluidly.

Warning	<input type="text" value="30"/>	%
Alarm	<input type="text" value="50"/>	%

- Static

Static settings are the statically entered impedance values that must not be exceeded or fallen short of. It does not matter which values the batteries hold when starting BACS. BACS will measure the respective battery and compare it with the impedance value entered right here.

	Min		Max
Warning	<input type="text" value="1,1"/>	mΩ	<input type="text" value="25"/>
Alarm	<input type="text" value="1"/>	mΩ	<input type="text" value="35"/>

- Baseline Impedance

The baseline method looks at each battery individually and compares the measurements with a user-defined measuring table that holds values for each single battery. This mode consists of 2 configuration steps:

Step 1: The threshold definition.

If a measured value deviates from the previous baseline by a percentage, a warning or alarm is automatically triggered.

Step 2: Determine Baseline Impedance

After initialisation, BACS regularly measures the internal resistance of all batteries. Click on Set to take over all measured values into a fix binding list.

Set latest BACS RI Measurements as baseline values	Set
---	-----

If a reference meter is in use, thy may also adjust the impedance values in milliOhms by entering offsets:

Impedance Offset
<input type="text" value="-3"/> mΩ

The last general step is to tell BACS the measuring interval for the impedance:

Impedance Measurement Interval	
Start at	12:00
Repeat every	12 hours

After configuration, BACS will regularly measure the internal resistance of the batteries. Should a battery deviate from the values accordingly, BACS will issue a warning or alarm.

How are these measurement methods brought together?

There are only 2 types of events

- Impedance Warning
- Impedance Alarm

These events are triggered independently by all 3 possible operating conditions. While the automatic mode considers all batteries as a whole, the static mode considers the fixed values that may not be exceeded or fallen short of. The baseline, on the other hand, is operated via a set of individual battery values combined with a pre-defined deviation range per cent.

All 3 trigger conditions can be set individually - the condition fulfilled in each case then serves as a trigger for an impedance warning or an alarm.

If you define several trigger conditions, make sure that these values are coordinated with each other!

Voltage

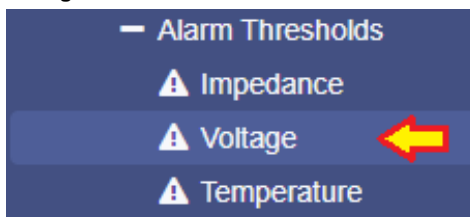

The voltage is important for batteries, it defines the electric field within which the current (the electron migration from technically plus to technically minus) is set in motion in the first place. The voltage in batteries is a very sensitive entity: over- and undervoltage can permanently damage and even destroy a battery.

Setting up battery voltage

At BACS>SETUP define which nominal voltage the batteries in use - BACS suggests the optimal default values for the nominal battery:

Battery	
Nominal Battery Voltage	12
Battery Model Type	All Lead Acid based
Nominal Capacity per Battery	7
Number of Batteries	6
Number of Battery Strings	2
Two Jars / Cells (NiCd) Per Module	<input type="checkbox"/>

Voltage	
Min	10.5 V
Max	14.1 V
Enable Max. Voltage Difference	<input type="checkbox"/>
	0

In most cases, these values will fit your batteries - please only change these values in consultation with the manufacturer of your batteries, as incorrect values can not only massively shorten the service life, but in the worst case lead to incorrect warning behaviour or permanently damage the batteries!

Voltage difference*Enable Max Voltage Difference*

Enable Max. Voltage Difference <input type="checkbox"/>	<input type="text" value="0"/> V
--	----------------------------------

In addition, BACS can inform you if individual batteries deviate in voltage by a certain value compared to all other batteries and warn you accordingly:

If all batteries are on average at 11.7V - 11.9V and one battery is at 10.6V, BACS will inform you if the deviation is set to +/-1V.

String Thresholds

If several battery strings are configured, BACS additionally provides an option to compare the voltage between the individual battery strings:

Enable String Thresholds <input checked="" type="checkbox"/>	<input type="text" value="0"/> V	<input type="text" value="1000"/> V
---	----------------------------------	-------------------------------------

With each failed battery, the voltage of the entire battery string drops. This allows conclusions to be drawn about the general condition of a battery string when evaluating a discharge/charge cycle:

If, during a discharge, one battery string suddenly drops noticeably compared to other battery strings, this is a general indication that something may be wrong and needs some attention.

Note:

Difference between „Warning“ and „Alarm“

BACS distinguishes between a definite alarm, where intervention is necessary, and a warning:

Both states are quite similar, different jobs can be freely defined for the corresponding levels - depending on the expansion phase and configuration, very delicate automatic processes can be initiated, which can range from informing to initiating active emergency measures, switching and regulating systems, etc. Depending on the system level and configuration design, it is also possible to redefine alarm as some kind of "escalated warning state". However, in case of an alarm condition, the acoustic alarm is additionally activated, the alarm LED changes its status and the alarm contact at the BACS Webmanager is actively opened.

The values are freely definable here, but one should ensure that the values for the warning are always reached in time before the values for an alarm, so that there is still enough time for an appropriate reaction.

Alarm Delay

Alarm Delay	
Enable Discharge Volt Alarm Delay <input type="checkbox"/>	<input type="text" value="1"/> Minutes

Wenn die USV im Einsatz war oder getestet wurde, ist die Spannung der Batterien verhältnismäßig niedrig. Hat die USV die maximale Zeit Betriebszeit in Anspruch genommen, kann es passieren, dass die Minimalwerte für den BACS Alarm ausgelöst werden.

Da die Zellspannung auch bei dem Ladevorgang nach der Entladung zunächst unterhalb der Warnlevel sind, würde das BACS-System unabhängig vom Lade-/Entladezyklus einen ausgeben müssen, weil der Wert außerhalb der definierten Grenzwerte ist.

Das Alarmverhalten nach einer Entladung wird über diese Einstellung um einen gewissen Zeitraum verzögert.

Tipp

Da Temperatur und Innenwiderstand beim Laden entscheidende Vorgänge indizieren können, wird der Alarm nur für den Menüpunkt *Voltage* gesetzt. In Kombination mit weiteren Indikatoren entsteht ein ganzheitliches Warn- und Alarmverhalten.

Temperature

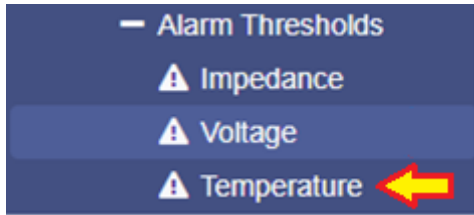

Unusual temperature fluctuations during the discharging and charging process must be observed and taken seriously, as batteries with too high operating temperatures can, in the worst case, unexpectedly generate a thermal runaway and catch fire. Each BACS sensor therefore also has its own temperature sensor to detect both the thermal radiation and the direct ambient temperature at a battery. Depending on the event configuration, a BACS Webmanager can immediately initiate counter measures via the integrated event management in case of evaluated temperature values exceeds the pre-defined range: Reaching alarming degree values are a latent danger for operational safety that must be encountered

Defining Warning und Alarm level

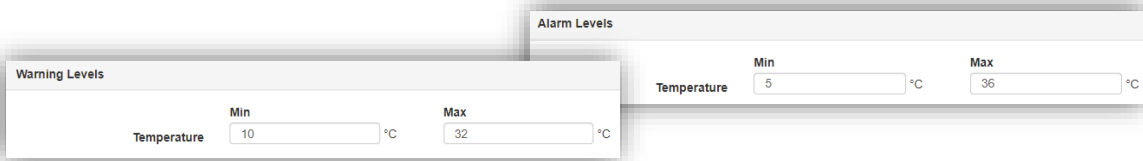

The "Warning" and "Alarm" levels depend on each other:

- Min: Defines the LOWER temperature range at which the operating and ambient temperatures become alarming or dangerous.
- Max: defines the UPPER temperature range that should not be exceeded.

When defining the values, please note that the alarm values are so-called escalation levels of the warning

Threshold type	Min	Max
Warning	10	32
Alarm	5	36

In this example

... the warning is given if:

- ... the lower temperature measurement drops below 10°C
- ... the upper temperature measurement exceeds 32°C
-

... the alarm is given, if:

- ... the lower temperature measurement drops below 5°C
- ... the upper temperature measurement exceeds 36°C

Setting up an offset value

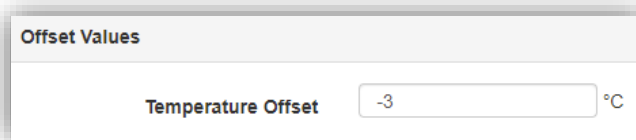

All BACS temperature sensors are factory calibrated and provide very accurate on-site temperature readings. Under certain operating conditions it may be necessary to harmonise the temperature values with external reference measurements.

In the offset, readjust the values collected by BACS according to your reference measurements.

Define BACS Battery strings

For this configuration step please navigate to the following menus

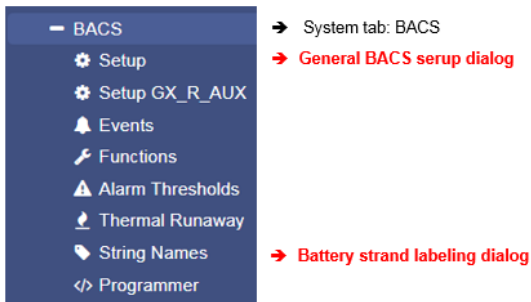

BACS offers the logical assignment of the individual batteries to so-called Battery strings.

The number of batteries is divided by the number of specified strings. The result is the logical assignment of the BACS module in single strings.

Example:

They have 72 batteries and define 6 single strings. The BACS system will present you with 6 battery strings of 12 batteries each, as entered after initialization. Basically, the assignment is made according as followed:

72 batteries divided by 6 strings will take 12 batteries per stand

Batteries 1 - 12	String 1
Batteries 13 - 24	String 2
Batteries 25 - 36	String 3
Batteries 37 - 48	String 4
Batteries 49 - 60	String 5
Batteries 61 - 72	String 6

After initialization, you will notice that BACS has renamed the modules:

If you have successfully included module 49, it would now be listed at battery strings 5 as module 1.

Note

The ID of the module has not changed, it remains the BACS module with the unique ID 49. What changed is the display context at the monitoring screen as well as general presentation of the data. Usually, the installation site and the string are coordinated so that module and string accordingly fit together.

If no project documentation exists, you can use this to identify the individual strings and search via the BACS Programmer.

Please note: The numbers of current sensors will be defined by the number of strings you define and label. You cannot define a specified number of current sensors, but you can:

- Use a current sensor for each single BACS string
- Use one current sensor for all BACS strings if installed at the master string
- Use one current sensor installed in one single string and use the multiplier to get information about all strings

BACS strings vs battery breaker

Furthermore, setting up BACS strings will harm the battery breaker setup:

The BACS Webmanager offers two options:

- One battery breaker for all strings
- One battery breaker for each string

Please note, depending on the number of strings, you may need up to 4 GX_R_AUX modules. The maximum number of battery breaker is 16.

Thermal Runaway

For this configuration step, navigate to the following menu:

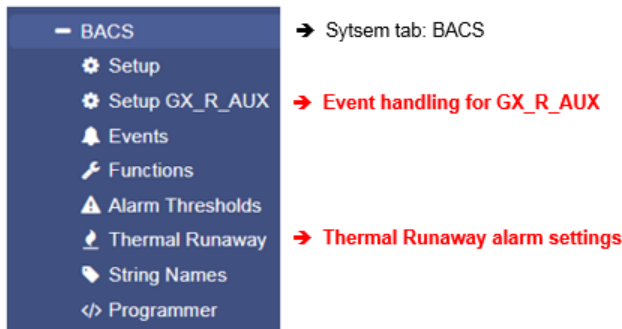

What is a „Thermal Runaway“?

A Thermal runaway is one of the most dangerous events that can happen when using battery systems. Batteries affected by thermal runaway are caused by, for example:

- Mechanical stress, e.g. penetration, impact, crushing,
- Electrical stress, e.g. incorrect charging currents, deep discharge, incorrect voltage settings ...
- Thermal stress, e.g. lack of cooling, external heat exposure, extreme coldness, environmentally caused basic operating temperatures ...
- Production failures, e.g. contaminated battery chemistry, poor quality management, poorly maintained production facilities, low-cost suppliers ...
- Operator errors, e.g. non-compliance of safety regulations, poorly trained personnel, misconfiguration, creative interpretation of security guides, work flow missmanagemend, ignored warning issues ...

In principle, during a thermal runaway, the battery heats up to such an extent that the internal chemistry becomes unstable and ultimately releases its energy abruptly through a short circuit in an exothermic reaction. This released heat energy in turn fuels the entire process and the battery is stuck in an overheating cycle that keeps building up. Overheated batteries can emit explosive, corrosive or oxygen-displacing gases, catch fire, explode or even damage neighbouring batteries via the metallic connecting elements or simply by bloating up and also initiate a short circuit and therefore a thermal runaway. A battery fire is also based on a toxic and unpredictable mixture of chemicals, the fumes from which make special protective clothing as well as special extinguishing agents indispensable.

For this reason, some countries in the world stipulate that if there are clear signs of a thermal runaway, the batteries must have the ability to completely disconnect from the UPS or the battery charging system in order to counteract an impending thermal runaway at an early stage.

How to configure BACS thermal runaway settings

For this step, the following pre-conditions are mandatory:

1. The number of batteries is configured
2. The number of battery strings is configured
3. Ideally, the strings are named
4. All BACS modules are registered, found and BACS is initialized and running.
5. Battery breaker are installed
6. GX_R_AUX are installed and ready to use

Open the tab „Thermal Runaway“:

At first, define the condition a BACS Webmanager shall assume a Thermal Runaway:

Max. Module Temperature Difference	<input type="text" value="20"/>	°C	→ temperature difference between BACS modules
Optional: Max. Current per String	<input type="text" value="10"/>	A	→ Current difference between strands*
Optional: Above Conditions Are True Since	<input type="text" value="30"/>	Minutes	→ Reference time: above should be fulfilled*

*Additional options based on the configuration and hardware-level of your BACS system

Max. Module Temperature Difference

Problems usually indicates in dramatic temperature increasments of individual batteries. The BACS Webmanager therefore measures the temperature of the individual batteries on each module.

This results in a basic statistical value from which individual batteries can deviate.

If boundary conditions are met, there is a clear indication of a thermal runaway. Depending on the hardware constellation, the protection circuitry physically disconnects affected string or all batteries from UPS / battery charger.

Max Current per String

Optionally, an additional conspicuousness can be included in the thermal runaway detection as soon as each string can use its own current sensor. Via the current sensor, a deviation of individual strings in relation to other strings can be measured:

Ideally, the strings are evenly loaded and unloaded. Irregularities and short-term deviations are familiar phenomena when dealing with batteries, large and long-term deviations are an indication of a broken battery, endangered for leading into a thermal runaway...

Above Conditions Are True Since

Diese Funktion definiert das Zeitfenster welches mindestens erfüllt sein muss, bevor der BACS Webmanager einen Thermal Runaway als erwiesen betrachtet. Über diese Funktion lassen sich unter anderem lokale Besonderheiten und grob planbare Umwelteinflüsse kalkulieren

Then define whether the battery breaker hast to trip:

Battery Disconnect

Do not trip Battery-Breakers

Trip single Battery-Breaker for all strings

Trip separate Battery-Breaker for each strings

Do not trip Battery Breakers

The beginning of a Thermal Runaway has been detected, but BACS is not supposed to control and trip battery breaker.

Trip Single Battery-Breaker for all strings

Exactly one battery breaker is installed, which disconnects for all batteries as soon as suspicious behaviour is observed on one battery.

Trip seperate Battery-Breaker for each strings

At BACS>Setup, there are several battery strings configured , and there is a battery breaker available for each **Number of Battery Strings** single battery string to allow separated tripping.

In this case, BACS will only disconnect the corresponding battery string, in which the damaged battery is located. If there are 3 strings, 3 battery disconnectors will be reserved in the GX_R_AUX:

If you then open the setup menu for the GX_R_AUX, the following changes have been made

GX_R_AUX 1

Input	Name	NC Contact	Output	Name	NC Contact
1	<input type="text" value="Warpkern"/>	<input type="checkbox"/>	1	<input type="text" value="Trip Battery-Breaker String 1"/>	<input type="checkbox"/>
2	<input type="text" value="Materie Injektor"/>	<input checked="" type="checkbox"/>	2	<input type="text" value="Trip Battery-Breaker String 2"/>	<input type="checkbox"/>
3	<input type="text" value="Antimaterie Injektor"/>	<input type="checkbox"/>	3	<input type="text" value="Trip Battery-Breaker String 3"/>	<input type="checkbox"/>
4	<input type="text" value="Magnetische Eindämmung"/>	<input checked="" type="checkbox"/>	4	<input type="text" value="Captain Picard fragen..."/>	<input type="checkbox"/>

This function automates the setup of the battery breaker. Depending on the type of battery breaker, there is the need to define whether the contact normally open or normally closed:

Open BACS event handling and search for BACS thermal Runaway String 1, 2 und 3 and unfold them:

		BACS Thermal Runaway St...	4	1	0	1	0	0
		Job Type	When	Parameter				
		Log	Once, immediately	{"text":"BACS Thermal Runaway String 1"}				
		RCCMD Trap	Once, immediately	{"text":"BACS Thermal Runaway String 1 in #LOCATION"}				
		E-Mail Trap	Once, immediately	{}				
		AUX	Once, immediately	{"port":"100","on_off":"1","text":"BACS Thermal Runaway String 100"}				

The BACS Webmanager automatically added an AUX-Job to switch the battery breaker.

Press the test button to check whether the battery breaker will be triggered and opens accordingly. If not, you need to configure the NC/NO-Contacts of the BACS GXR_AUX to the correct position and check wiring at the device itself.

Note

If you configure the Thermal Runaway after configuring GX_R_AUX outputs, be sure to check for previously entered events for plausibility:

You may also need to open the battery interrupters for other reasons, the Thermal Runaway configuration dialog will only work on a specific scenario and configuration routine automatically:

The outputs are renamed and a preconfigured job is automatically added to the corresponding events. Since the BACS Web Manager cannot know why you entered these additional conditions, BACS will not remove all your configurations automatically-

It is up to you to check them manually.

Maintenance: Replacing BACS modules

Unfortunately, even in the best systems, it can occasionally happen that a module shows an abnormality that makes it necessary to replace it.

Replacing a BACS module is easy, but you need to follow these few rules:

1. Find the module ID of the module you plan to replace
Normally, the BACS WEBMANAGER tells you which module is defect.
2. Program the module to the ID the old module uses.
3. Program the spare parted module to the correct ID. The ID 0 is preset ex works; therefore, you can simply set the ID 0 to the desired ID accordingly via the 'Single Mode' of the BACS Programmer.
4. Replace the old module with new spare part module
Remove the defective BACS module and connect the new BACS module.
5. check if the ID is correct
At the start of BACS,
 - a. ensure there are no ID duplicates in the BACS bus,
 - b. ensure, that all BACS modules are continuously numbered
6. Restart BACS - the new module will be detected and queried automatically.

Which BACS module can be used as spare part?

In principle, you can re-arrange all BACS modules as you wish as long as you use only one battery string.

But you cannot mix different hardware revisions of the BACS modules! At the BACS Monitor, the BACS module hardware revision is provided:

Module info		Batte
Module type	C20	Manu
Hardware Version	03.02	Type
Software Version	03.02.02	Capa
Number of Blocks	3	Instal
Number of Strings	1	Phon
Contact Person		Locat
IP Address	10.10.10.10	Mac #

Why is the revision number for this BACS system correct?

During initialization phase of BACS after configuration work is done, the module with ID 1 is read in and all subsequent modules are compared with this hardware revision version.

By doing so, the BACS system quickly finds the wrong modules.

For more information, please refer to the chapter *BACS Error: HW / Calibration error*

BACS LOG files

The BACS log files provide extensive information about your batteries managed by BACS:

- temperature values
- Charge / discharge cycles
- Internal resistance of the batteries
- Current fluctuations
- Operating time
- etc

These log files allow deep battery analyzes for both, the current system states and for any single battery state within a battery string.

In addition, these valuable data can be used to track the battery life cycle since installation and even make reliable predictions about impending failures - important information for planning of maintenance intervals.

The BACS web manager has 30 MB of exclusively reserved memory in order to reliably save all BACS log data.

Rotating memory management provides maximizing available log files

With rotating storage management, the data is initially stored continuously up to the maximum usable storage size.

If the maximum available storage space is reached, the oldest entry is deleted in order to obtain the necessary space for the new data. By doing so, the BACS WEBMANAGER grants a continuous data history.

Size of the time window before the oldest log files will be erased

You can actually only estimate an average time window, because the amount of data is shaped not only by the number of modules, but also by the type of use in combination with unforeseeable incidents.

As an example:

- One single BACS module ...

generates about 700 bytes in one day in normal operation without battery discharge cycles. If your system consists of only 1 module, the memory would need more than 29,000 days before the first day will be deleted to save the latest data.:

The local saved battery data log would show about 80 years - this is nearly an average human lifetime.

- A standard UPS system with 40 batteries...

will generate with 40 * 700 bytes about 28000 bytes per day in normal operation. The BACS web manager could therefore hold and provide over 1000 days. You can assume that the 2 - 2 1/2 years are available

The crux of the standard application, however, can be found within the definition and the details of a memory calculation. In case of a discharge cycle, the data logging frequency increases in order to ensure traceability and analysis of the discharge:

Due to the increased measuring frequency during the discharge cycle, each BACS module generates approx. 9300 bytes. When we assume a special and very theoretical discharge scenario (normally the batteries are depleted long before), the BACS web manager could record the discharge for a standard UPS with 40-60 batteries in this scenario up to 17-18 hours continuously.

Note:

What is such a „theoretical discharge scenario“?

Usually, a power failure itself cannot be planned, but the batteries can be found at a foreseeable site when this happens. As soon as the EDP has been shut down, the UPS can also be switched off. How long the UPS will grant emergency power depends on the capacity of the UPS as well as the number of devices that must be feed with emergency power.

However, there is also the possibility that you have a mobile EDP system with limited main power usage that comes with the problem a hardware shutdown is not an option (e.g. a tectonic sensor grid). Minor power usage may lead into a very long emergency power operating time via the UPS. In this special scenario, the battery data can provide valuable insights to improve reliability with some limitations.

- A large UPS solution with 120 managed batteries...

When normal operation is active, the BACS WEBMANAGER would generate with 700byte * 120 units an impressive amount of data of up to 84,000 bytes - Keep in mind that these data are not "image files", we are talking about numerical values that are in a table and can be converted into graphic tables if necessary.

In this case, the BACS WEBMANAGER B4 can keep this immense amount of battery data for up to 238 days before the oldest files have to be overwritten.

The data will be available for about 7-9 months.

During a discharge, the measuring frequency is increased as described above. In a very large battery system with up to 120 batteries, a BACS web manager can still hold records of the discharging process between 8-12 hours, the amount of collected data is difficult to imagine.

To save the data permanently, the log files can be exported. How often this is necessary depends on the size and use of the entire system:

In the case of very large systems, it is usually sufficient to back up the data about once a month in order to have a closed history of all battery data in an emergency. Data from a very large system, which very often changes to the discharge state due to usage, should be saved more frequently accordingly.

What are all these data used for?

Yes, why should you keep the data ... a good question!

As already mentioned, deep analyzes and a qualified current battery system health status can be generated as well as status reports for time windows needed for the maintenance work. Indicators such as a steadily increasing internal resistance reflect the natural aging process of a battery and indicate the end of use. In case of system malfunction, all these data are also useful for a reconstruction of the incident, because the battery data help to classify the malfunction in a clear and unambiguous timeline.

They provide valuable additional insights and help to improve the safety net and demonstrate weak points within the UPS solution.

Special applications, on the other hand, can be better planned and implemented because, for example, the findings could be used within a simulation program and proof-of-concept studies can be carried out for future UPS concepts.

So there are a few reasons to back up this data - the value of this data depends on what you want to do with it.

Note:

After a long discharge cycle, it takes a some time for the batteries to be recharged. We recommend picking up and analyzing the data after charging process is finished:

Not only for saving data, you can also see directly whether the batteries have been correctly recharged - you will get valuable information about the current state of health of the entire system. You can instruct the BACS WEBMANAGER to inform you as soon as the batteries are fully charged.

BACS will inform you if:

- ... there are complications in which an intervention is inevitable or imminent.
- ... the loading process was successfully completed.

Retrieve BACS log data

There are different options to get the BACS log files

Via Web interface

For this step you need the following menu:



The BACS log files can be downloaded directly from the BACSLog menu.

For the evaluation, we recommend the professional analysis tool BACS Viewer, which is available as freeware in the download area of our website www.generex.de.

The BACS WEBMANAGER provides two different options:

:

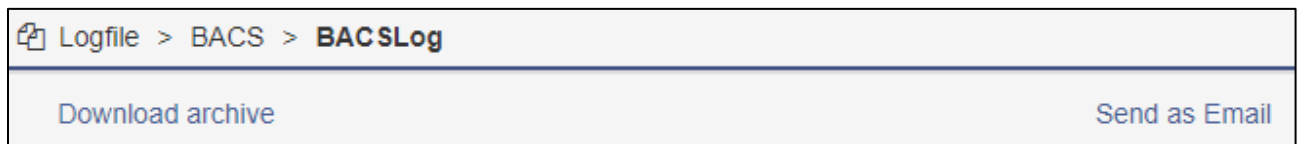

Download archive

You can call up all available log files directly via the integrated web interface. The data is packed in real time and the download starts automatically as soon as the file is available. Please note, that the time window to generate the data strongly depends on the amount of available data.

Send as Email

For this function, you need to configure the build-in mail client before using this function.

The BACS web manager offers you sending available log files via email to any email address. Since the data attachment can be up to 20 MB, it is recommended to limit the amount of data accordingly:

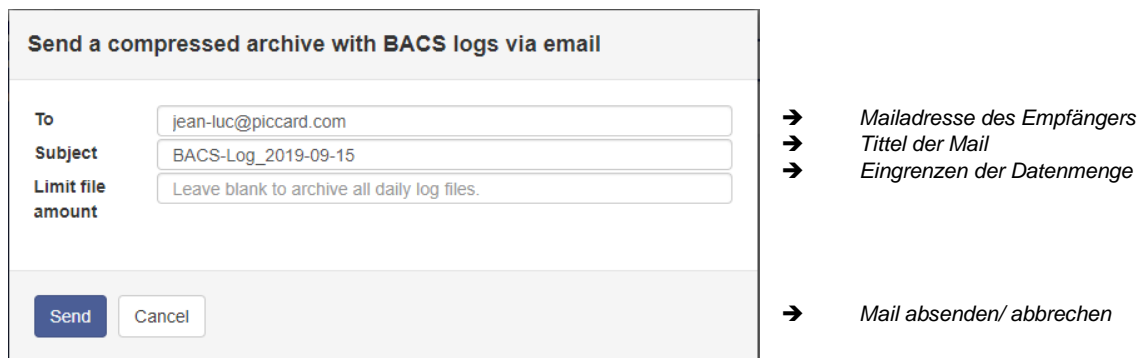

Mail servers are now sensitive to large attachments, since many users have lost the feeling for file sizes - attaching content with more than 10 MB to emails may cause problems when sending and receiving emails. As a consequence, administrators and service providers have often reduced the size of the attachments. If the attachment is too large, the email will be sent without the attachments or emails will be simply refused by the incoming mail server...

With this function you can - based on a daily report - enter the desired number of hours. If you e.g. enter a 7, the BACS will mail the last 7 hours.

Note
The maximum size of the packed file is 20 MB - the real size of the file and the amount of hours that could be found within the log file depends on the type of use and the size of the files.

Direct download via SFTP

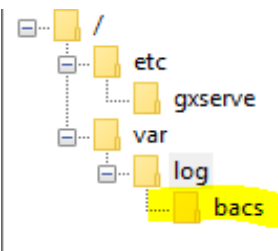

You can access the data directly via the integrated download server of the BACS WEBMANAGER - use any SFTP client - there is no limitation which client you should use.

Access data:

IP: <die IP address of your WEBMANAGER>
 Port: SFTP / Port 22
 User: admin

Passwort: cs141-snmpp or your specific admin password

After logging in, open the directory var/log - here you will find all BACS log files. Simply copy the files to your hard drive - you can later evaluate the log files with professional battery analyzing tool BACS-Viewer.

Direct download and evaluation via BACS-Viewer

You may also use

the SFTP client that is an integrated part of the BACS Viewer. To do this, enter the IP address and the desired time window.

The BACS viewer will automatically connect to the corresponding BACS web manager and collect the corresponding files.

If wanted the BACS viewer can be instructed to automatically query all registered BACS web manager when the software starts..

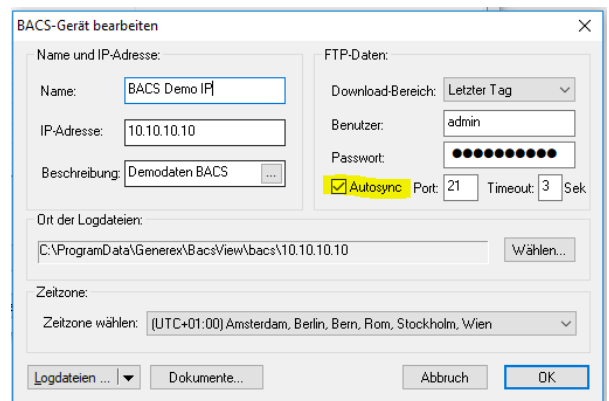

Note:

The BACS viewer software is a powerful freeware battery analysis tool.

You can download the software and manuals from our download area at www.generex.de.

Pause Equalization on schedule

For this configuration step, you need the following menu:

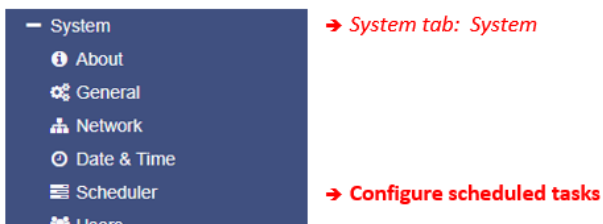

This hidden function is a little bit difficult to explain without basic information about the production process of a battery – please read the following information carefully, it will explain you why this function is very powerful and how set up the most effective configuration that fits to your batteries ...

Depending on the manufacturer and production process, AGM batteries require a few charge / discharge cycles to achieve the optimum performance for a standby mode of a UPS. The number of chards / discharge cycles you need to form up your batteries is a technical puzzler:

Basically, there are two different production methods for batteries:

Formed accumulators

As a post production process, formed accumulators were repeatedly charged and discharged. By doing so, the battery chemistry itself will perform a so-called recombination. Caused by the entropy during the charge / discharge cycle, the recombination of the battery chemistry will stabilize the internal resistance of the entire accumulator. As a side effect, the accumulator's capacity will be maximized.

Unformed accumulators

These batteries are produced, packed and sold directly without any post production service. The entire forming process is a part of the final installation on site. The forming process will be performed by the customer during first months of usage - as an example, while running battery stress tests or by random power failures. In the end, these batteries will also reach full capacity as well as a stabilized internal resistance, but it will take much longer than batteries that are formed before installation on site.

OK, but why does unformed accumulators exist?

There is no legal standard that dictates forming - accordingly, it is a service of battery manufacturers and is a quality feature of recently produced batteries. As a consequence, it is up to the manufacturer how he wants to produce and sell his batteries:

While some manufacturer only supplies formed batteries as a quality standard, other manufacturer design two different product lines or produce as cheap as possible.

Note

From a technical point of view, no differences can be observed between the formed and unformed batteries during commissioning - all accumulators that have been assembled to a battery system have to perform such a formation process. The difference is that already pre-formed accumulators can finish this process much faster. Please note, the "formation is finished" can only be seen when evaluating the battery data collected by BACS.

In principle, BACS eliminates generally harmful voltage fluctuations.

As a result, formed batteries are spared and can be used over a very long time - sometimes even beyond the manufacturer's specifications about the design life of a battery. However, if batteries are unformed at start-up, balancing or equalizing, especially in the early days, could slow down the formation process enormously, because the accumulators need these voltage fluctuations.

Determining the optimal time from to hand over the equalization of your BACS system completely, depends, among other things, on the basic operating mode:

Scenarios with a cyclic usage

In the case of cycling applications, formation takes place automatically as there is generally a regular charge / discharge cycle. This means BACS can run immediately and your batteries will reach their maximum capacity very quickly.

Scenarios with a stand-by usage

In case of standby applications, the situation differs:

Because there is no cyclic discharge, the formation is carried out by natural voltage fluctuations of the UPS. As a consequence, a system that mostly eliminates voltage fluctuations slows down the entire formation process.

How to use „Pause Equalization“

As you can see, only Chuck Norris has an automatic battery forming process because his roundhouse kick will teach the batteries what they want to do... In all other cases it is technically not possible because the batteries can vary enormously depending on batch, grade, manufacturer, chemical composition, storage time after production, storage location, etc. It can actually happen that two batteries from the same manufacturer need completely different time windows until they reach the formed state - New BACS-controlled UPS systems must be observed individually.

Pause Equalization is thus a kind of "pause function" to facilitate the structured formation or reformation of batteries. To use this function, open the scheduler and select the job Pause Equalizing:

Add/Edit Scheduler Task		
Job	<input type="text" value="Pause Equalizing"/>	→ Select the job "Pause Equalization"
Parameter	Hours: <input type="text" value="2"/>	→ Toggle the time in hours the equalization process shall pause
Timing	Start: <input type="text" value="09/03/2019 02:50 PM"/> Repeat: <input type="text" value="One Time"/>	→ Set up the job timing
Triggers	At 02:50 PM on 09/03/2019 - one time	
<input type="button" value="Save"/> <input type="button" value="Cancel"/>		→ Save changes / discard changes

Setting up Hours and job timing

How many hours you want to pause equalizing is difficult to answer - BACS can facilitate and accompany the formation process in many ways. Here are 3 examples how to configure the BACS function pause equalizing:

Method 1: As easy as possible

Pause Equalizing for 5 days and repeat the job:

In this case, choose 120 hours and advice the CS141 to repeat once in a week:

The BACS Webmanager will pause equalizing for 120 hours or 5 days. The UPS is this given the chance to advance the battery formation 5 days a week. Then the BACS Webmanager will enable Equalizing for 2 days and generate comparable data. After an overall period of 7 days, the job will be re-run ... The BACS Web Manager Monitoring will always inform you if something with the batteries is not working as expected, even if Equalizing is temporarily disabled or pausing.

Use a second job to get status information about the forming process:

On initial start, the BACS Webmanagers integrated monitoring system starts collecting all required battery data for a detailed forming status evaluation. Just add a scheduled mail and the BACS Webmanager will send your regular status reports including necessary log files. You do not need daily reports, getting a status mail once a month should be enough to decide if the forming process is finished. If there an additional problem occurs:

BACS will inform you immediately....

During data evaluation, what are you looking for?

As an example, if you start with 40 unformed batteries, you will notice that each battery will show individual charge/discharge voltages. This is not an issue, it is natural for both, pre-formed and unformed batteries. With each discharge / charge cycle, the voltage curves of all batteries approach each other until they are only about 1V apart. If this can be seen, batteries are in sync and the forming process is largely completed. You may quit and delete the scheduled job "Pause Equalizing" and BACS begins its work.

With this method, you can evaluate the battery data once a month and are informed about the current state of health of the batteries. As soon as the battery data reaches formation parameters and indicates that the formation has been completed successfully, the Pause Equalizing job can be adjusted or removed accordingly.

Method 2 – during running – faster but time-consuming

You can also instruct the BACS web manager to take control step by step.

If you choose running this way, equalizing is configured to pause each day for a specific time window. The advantage is that your UPS system is not on its own for the first few weeks. BACS has an eye on it and equalizing is most of the week enabled.

This method allows to plan special charge/discharge cycles without BACS equalizing provides and speed up the forming process. As an example, if your batteries have a discharge/charge cycle of about 6 hours, you can plan a "not-equalized time window of 6 hours" daily, weekly – you can customize this time window to fit to your conditions.

In this example, the job Pause Equalizing will stop the equalizing process from 6:00pm Uhr to 11:00pm.

This will provide a unique time window to run a custom discharge / charge cycle and log the voltage behavior of the batteries. This method could be very interesting if you change some batteries and mix some new with old batteries. Equalizing will save your existing, already formed batteries and your new batteries have the chance to form up with all other batteries.

In this example, we will use a periodic message reporting - if you know that equalizing pauses from 6:00 pm to 11:00 pm, you could create a "formation report" and get the according log files by mail:

Add/Edit Scheduler Task

Job EMail

Parameter

Receiver

Text

Use text as subject

Eventlog

Datalog

Bacslog

Timing

Start

Repeat

Triggers At 06:00 PM - every day

Timing	
Start	<input type="text" value="23:15 PM"/>
Repeat	<input type="text" value="Weekly"/>
	<input type="checkbox"/> Sun <input checked="" type="checkbox"/> Mon <input type="checkbox"/> Tue <input checked="" type="checkbox"/> Wed <input type="checkbox"/> Thu <input checked="" type="checkbox"/> Fri <input type="checkbox"/> Sat
Triggers	At 11:15 PM - every Monday, Wednesday, Friday

In this case, set the je-mail job timing to Weekly and instruct the BACS WEBMANAGER to generate a status mail with the current battery data at 23:15 on Mondays, Wednesdays and Fridays.

As a consequence of a scheduled hour-by-hour formation of batteries, the entire formation process will take some more time:

Technically, the internal battery chemistry is calmed by eliminating the necessary voltage fluctuations associated with equalization - this will slow down the forming process.

On the other hand, evaluating of data is easier because you can directly compare how the batteries behave. This will allow you to determine very precisely when there will be no improvement in the voltage values and fully activate the equalization with pinpoint accuracy. As a side effect, you may train to spot strange measuring data.

Method 3 – Completely scheduled with unique single jobs

If you choose to climb this way, you need some experiences about using batteries and their behavior when equalize them. In general, the sense of scheduled tasks is to plan jobs and execute them automatically when the time has come to trigger a function. You may choose between cyclic jobs like sending mails with log files or single jobs like a small text message to your RCCMD client to remember yourself a single event is pending.

However, the advantage of this method is, that you can design and configure a general road map to form the batteries. As an example, it may look like this job list:

- Enable Equalizing for 2 days
- Send an email with log files for data evaluation
- Pause Equalizing for 7 days
- Send an email for data evaluation
- Enable Equalisation for 3 days
- Pause Equalizing for 5 days
- Send a mail with log files for data evaluation
- Pause Equalizing the next 7 days for some hours
- Send a mail with log files for data evaluation
- [...]

This will allow you to create a normalized 6-month battery forming procedure. To abort this scheduled task list because the forming process is finished earlier than expected, just delet this job list.

Note:

Forming new battery systems is an individual matter that largely bases on experience. In general, you can say:

Unformed high-quality batteries reach the final operating state faster than unformed less-quality batteries. But it is also possible that pre-formed low-quality batteries may surprise you very much.

Please keep in mind, each battery system is a unique installation that needs an individual point of view.

Tutorial: BACS deactivated by System

BACS: ● Equalizing automatically disabled by System

BACS - BIT-2A - UPS-B4

● Warning: Equalizing deactivated by System
● Status: Charging

String 1 Pos						String 1 Neg						String 2 Pos						String 2 Neg					
No.	Volt. [V]	Temp. [°C]	Ri. [mΩ]	Equalize	Status	No.	Volt. [V]	Temp. [°C]	Ri. [mΩ]	Equalize	Status	No.	Volt. [V]	Temp. [°C]	Ri. [mΩ]	Equalize	Status	No.	Volt. [V]	Temp. [°C]	Ri. [mΩ]	Equalize	Status
1	13.63	24.5	10.96		●	21	13.28	27.4	9.20		●	41	13.63	25.0	11.21		●	61	13.61	26.5	9.76		●
2	13.63	25.0	11.70		●	22	13.49	27.0	11.39		●	42	13.63	23.6	10.39		●	62	13.61	26.5	10.31		●
3	13.63	24.5	11.39		●	23	13.64	25.4	6.05		●	43	13.63	25.5	12.01		●	63	13.61	26.9	12.11		●
4	13.63	24.3	5.70		●	24	13.41	25.5	11.46		●	44	13.63	25.5	11.19		●	64	13.61	25.1	12.04		●

With its management functions, BACS actively intervenes in the control process and thus guarantees the optimal charging conditions for each individual battery within the according battery string.

The equalizing level is active for 3 of 4 battery strings. BACS manages each single batteries individually and adjusted them perfectly to the target voltage. However, for the 4th battery string called "String 1 Neg", BACS displays that the equalizing functions was disabled for some reason.

Why does BACS disable balancing?

BACS regularly checks whether there is an improvement in the voltage - by doing so, balancing (equalizing) makes sense to the BACS WEBMANAGER, and he will continue with balancing. With some operating conditions, however, it can always happen that BACS would be able to manage the charging current individual to each battery in the battery string, but not without permanent 100% balancing (equalization) and only without any measurable improvements.

In addition to the classic that a battery simply becomes stubborn for literally inexplicable and incomprehensible reasons, there are usually 3 scenarios in which BACS can conclude that equalizing is theoretically possible, but practically examining the batteries should be:

1. New and old batteries or batteries from different manufacturers were mixed

Since BACS adjusts the charging currents individually to the needs of the battery through balancing, a special feature of BACS is that individual batteries can in principle be exchanged as you wish. If you decide to use another manufacturer, the performance data and battery type can be similar, but the internal battery chemistry differs depending on the grade and mixing ratio or how redox reaction runs during the charging process, etc. Finally, this can lead into big differences between the stock batteries that simply cannot be balanced over a long period of time – BACS will assume that exact this single battery will never fit to the desired battery string.

2. Damaged batteries and wiring problems

While a hidden battery damage can appear again and again as an unpredictable factor, with this warning message you should take another look at the batteries and the cabling, especially after maintenance work. Even if the system itself could run without error notification in its existing configuration, the values collected indicate that something is fundamentally wrong, because at least one module is always running on 100%.

3. Old batteries

With ongoing aging, batteries will take over a very individual voltage, charging and capacity behavior and drift apart - in this case, a core task of BACS is to intervene in the charging cycle and thus create an individually optimized charging environment. As a consequence, the age of the batteries also increases the intensity with which balancing has to be carried out.

When the batteries reach the calculated design life, it may become noticeable that BACS has run its balancing up to 100% for some batteries within a battery string, but without any significant improvements. Although everything is set correctly, BACS will report this information as "Equalizing deactivated by system" and pauses the equalizing accordingly.

String 1 Neg						
No.	Volt. [V]	Temp. [°C]	Ri. [mΩ]	Equalize	Status	
21	13.28	27.4	9.20		●	
22	13.49	27.0	11.39		●	
23	13.64	25.4	6.05		●	
24	13.41	25.5	11.46		●	
25	14.10	26.7	11.58		●	
26	13.42	25.5	10.76		●	
27	13.46	26.0	10.82		●	
28	13.42	25.5	10.49		●	
29	14.01	26.0	12.26		●	
30	14.14	25.5	12.26		●	
31	13.40	26.0	11.86		●	
32	13.50	25.5	5.83		●	
33	13.42	26.5	10.77		●	
34	13.43	25.5	12.21		●	
35	13.97	25.0	11.25		●	
36	13.38	24.7	12.30		●	
37	14.00	26.1	11.77		●	
38	14.08	25.8	11.68		●	
39	13.63	25.5	11.84		●	
40	13.39	25.0	10.76		●	
Σ Voltage 272.58 V						
13.63 [V] Target Voltage						
-1 [A] Current -0.27 [KW] Real Power						

Trouble Shooting List

This table shows an event overview and generally recommended actions for helping with maintenance work.

EVENT Name	Event description	Explanation	Recommended reaction
BACS started	Battery monitoring started	BACS System has started and is now managing batteries	For your information.
BACS Discharging Phase	Battery discharging	BACS System noted that a discharge has started	Check Charger output status and Battery Breaker
BACS Charging Phase	Battery charging	BACS System is back to normal from a previous discharge.	For your information. Watch if batteries charge correctly.
BACS System Alarm	Module communication is lost and the system is in Alarm mode! React immediately!	BACS system is not functional at this status and needs attention	Intervention required: Check communication cable and addressing
BACS System Alarm off	Module communication restored	BACS System communication problems cleared	For your information
BACS Voltage High Alarm	BACS Voltage High Alarm	BACS System detected one or more batteries with voltage out of the configured alarm threshold.	Check battery health and charger
BACS Voltage High Alarm off	BACS Voltage High Alarm reset	BACS System High Alarm cleared	For your information.
BACS Voltage Low Alarm	BACS Voltage Low Alarm	BACS System detected one or more batteries with voltage out of the configured alarm threshold	Check battery health and charger
BACS Voltage Low Alarm off	BACS Voltage Low Alarm reset	BACS System Low Alarm cleared	For your information
BACS Temperature High Alarm	BACS Temperature High Alarm	BACS System detected one or more batteries with temperature out of the configured alarm threshold	Intervention required: Check charger and environmental conditions and watch if temperature increases or comes back to normal. Check if balancing is active and if ampere rating of battery is correctly configured. If both are correct, check battery health to avoid a thermal runaway.
BACS Temperature High Alarm off	BACS Temperature High Alarm reset	BACS System High Alarm cleared - No action	For your information.
BACS Temperature Low Alarm	BACS Temperature Low Alarm	Temperature of one or more modules are beyond the configured alarm threshold.	Check environmental conditions
BACS Temperature Low Alarm off	BACS Temperature Low Alarm reset	BACS System Low Alarm cleared - No action	For your information.
BACS Resistor High Alarm	BACS Resistor High Alarm	Resistance/Impedance of one or more modules are beyond the configured alarm threshold.	Check battery health and voltage level
BACS Resistor High Alarm off	BACS Resistor High Alarm reset	BACS System High Alarm cleared.	For your information.
BACS Resistor Low Alarm	BACS Resistor Low Alarm	Resistance/Impedance of one or more modules are beyond the configured alarm threshold	Check battery health and voltage level
BACS Resistor Low Alarm off	BACS Resistor Low Alarm reset	BACS System Low Alarm cleared - No action	For your information.
BACS Voltage Diff High Warning	Voltage difference between single batteries/cells to high	Battery Voltage difference within one or more battery strings are beyond the configured threshold.	check battery health
BACS Voltage Diff High Warning off	Voltage difference between single batteries/cells reset	Battery Voltage difference within one or more battery strings are back to normal	For your information
BACS Battery Breaker open Alarm	Battery breaker/fuse open, no battery protection active!	Battery breaker or Battery fuse has been opened.	Intervention required: Check battery breaker/fuse status immediately in order to prevent loss of load in case of a power outage.
BACS Battery Breaker open Alarm off	Battery breaker/fuse closed	Battery breaker/fuse is normal again, batteries should again pick up charge - no action	For your information, it is recommended to check the battery breakers and fuses
BACS Equalizing Error Alarm	Equalisation error	BACS Equalisation Failure automatically stops all balancing functions	Reboot/Coldboot the system and wait for clearance. If the problem cannot be solved by the BACS itself after some hours, call BACS support.

BACS Equalizing Error Alarm off	Equalisation error reset	BACS Equalisation Failure cleared	For your information.
BACS Voltage High Warning	BACS Voltage High Warning	BACS System detected one or more batteries with voltage out of configured warning threshold	1. Check if voltage increases or comes back to normal. 2. Check if balancing is active and ampere rating of battery is correctly configured. If both are correct, check battery health
BACS Voltage High Warning off	BACS Voltage High Warning reset	BACS System High Warning cleared.	For your information.
BACS Voltage Low Warning	BACS Voltage Low Warning	BACS System detected one or more batteries with voltage out of configured warning threshold.	1. Check if voltage decreases or comes back to normal. 2. Check if balancing is active and ampere rating of battery is correctly configured. If both are correct, check battery health
BACS Voltage Low Warning off	BACS Voltage Low Warning reset	BACS System Low Warning cleared.	For your information.
BACS Temperature High Warning	BACS Temperature High Warning	BACS System detected one or more batteries with temperature out of configured warning threshold.	Check charger and environmental conditions and watch if temperature increases or comes back to normal. Check if balancing is active and ampere rating of battery is correctly configured.
BACS Temperature High Warning off	BACS Temperature High Warning reset	BACS System High Warning cleared.	For your information.
BACS Temperature Low Warning	BACS Temperature Low Warning	BACS System detected one or more batteries with temperature out of configured warning threshold.	1. Check if temperature decreases or comes back to normal. 2. Check charger and battery breaker and environmental conditions.
BACS Temperature Low Warning off	BACS Temperature Low Warning reset	BACS System Low Warning cleared.	For your information.
BACS Resistor High Warning	BACS Resistor High Warning	BACS System detected one or more batteries with impedance out of configured warning threshold	Check if voltage and temperature is correct. If problem persists, call battery service to check battery health
BACS Resistor High Warning off	BACS Resistor High Warning reset	BACS System High Warning cleared	For your information.
BACS Resistor Low Warning	BACS Resistor Low Warning	BACS System detected one or more batteries with impedance out of configured warning threshold.	Check if voltage and temperature is correct. If problem persists, call battery service to check battery health
BACS Resistor Low Warning off	BACS Resistor Low Warning reset	BACS System Low Warning cleared.	For your information.
BACS General Alarm	General failure/alarm, check website BACS for Alarm details	BACS System detected an Alarm, what trigger always the general alarm.	Check BACS Webinterface and Logfile for Alarm detail and take a look to the recommended action for it.
BACS General Alarm off	General failure/alarm reset	BACS System general alarm cleared.	For your information.
BACS Thermal Runaway Alarm	Thermal Runaway conditions TRUE	Thermal runaway risk at this string.	Intervention required: Check temperature and voltage and battery health.If battery breaker has been opened, check battery health before closing the breaker
BACS Module Fuse Blown	No measuring data available by defect.	One or more batteries cannot be managed or monitored by BACS, but are still connected to the charger.	Intervention required: For some reason, the BACS measuring cable fuse was triggered. Check both, wiring and batteries for damages, and replace the measuring cable.
BACS Thermal Runaway Alarm off	Thermal Runaway conditions FALSE - Normal	Thermal runaway alarm cleared	For your information: Evaluate data to find the reason why a thermal runaway alarm happened.
BACS Discharge Counter Alarm	Discharge Counter beyond configured threshold	Configured number of discharges reached.	Check battery health and decide if more cycles can be accepted
BACS Discharge Counter Alarm off	Discharge Counter reset	Discharge Counter has been reset to 0	For your information.

BACS GX_R_AUX 1 Input 1 Alarm Off	GX_R_AUX DigitalInput 1 LOW	Connected dry contact closed/opened, action depends upon connected application.	Action depends on connected application.
BACS GX_R_AUX 1 Input 1 Alarm	GX_R_AUX DigitalInput 1 HIGH	Connected dry contact closed/opened,	action depends upon connected application.
BACS Baseline Impedance Alarm	BACS Baseline Resistor High Alarm	Resistance/Impedance of one or more modules are out of the percentual baseline alarm threshold.	Check battery health and voltage level
BACS Baseline Impedance Alarm Off	BACS Baseline Resistor High Alarm reset	Alarm / warning cleared.	For your information.
BACS Baseline Impedance Warning	BACS Baseline Resistor High Warning	Resistance/Impedance of one or more modules are out of the percentual baseline warning threshold.	check battery health and voltage level
BACS Baseline Impedance Warning Off	BACS Baseline Resistor High Warning reset	alarm / warning cleared.	For your information.
BACS String Voltage High Alarm	String voltage too high	String voltage out of configured threshold.	Check Charger and battery health
BACS String Voltage High Alarm Off	String voltage alarm reset	alarm / warning cleared.	For your information.
BACS String Voltage Low Alarm	String voltage too low	String voltage out of configured threshold.	Check Charger and battery health
BACS String Voltage Low Alarm Off	String voltage alarm reset	alarm / warning cleared	For your information.
BACS String Voltage High Warning	String voltage high	String voltage out of configured threshold.	Check Charger and battery health
BACS String Voltage High Warning Off	String voltage warning reset	alarm / warning cleared	For your information.
BACS String Voltage Low Warning	String voltage low	String voltage out of configured threshold.	Check Charger and battery health
BACS String Voltage Low Warning Off	String voltage warning reset	alarm / warning cleared.	For your information.
BACS String Current High Alarm	Positive (Charging) String current too high	String current out of configured alarm threshold. Check Charger and battery health	Check Charger and battery health
BACS String Current High Alarm Off	String current alarm reset	alarm / warning cleared	For your information.
BACS String Current Low Alarm	Negative (Discharging) String current too high	String current out of configured alarm threshold.	Check Charger and battery health
BACS String Current Low Alarm Off	String current alarm reset	alarm / warning cleared	For your information.
BACS String Current High Warning	Positive (Charging) String current high	String current out of configured warning threshold.	Check Charger and battery health
BACS String Current High Warning Off	String current warning reset	alarm / warning cleared - no action	For your information.
BACS String Current Low Warning	Negative (Discharging) String current high	String current out of configured warning threshold.	Check Charger and battery health
BACS String Current Low Warning Off	String current warning reset	alarm / warning cleared.	For your information
BACS Module Revision Alarm	Wrong/Incompatible module revision in BACS bus found	Installation of different BACS module revisions or missing module revision information may trigger this alarm.	This is an installation error, different hardware revision modules has been used. Contact BACS support.

BACS Module Revision Alarm Off	Module revision alarm reset	alarm / warning cleared	For your information.
BACS Equalizing deactivated by System	Balancing/Equalization does not take effect for up to 4 days.	If the balancing/equalisation does not show any effect on one or more modules/batteries, it will be turned off after some time and this warning is triggered	Check battery health
BACS Equalizing deactivated by System Off	Balancing/Equalization restarted - warning reset	alarm / warning cleared	For your information.
BACS String Current Deviation Discharge Alarm	Discharge Current difference between strings too high	BACS has noticed there is a problem when string current measurements deviates compared to other strings during a discharge cycle.	Check Charger and battery string health
BACS String Current Deviation Discharge Alarm Off	Discharge Current difference between strings Alarm reset	alarm / warning cleared - no action	For your information.
BACS String Current Deviation Charge Alarm	Charge Current difference between strings too high	BACS has noticed there is a problem when string current measurements deviates compared to other strings during a charge cycle after discharging.	Check Charger and battery string health
BACS String Current Deviation Charge Alarm Off	Charge Current difference between strings too high reset	alarm / warning cleared	For your information.
BACS String Current Deviation Discharge Warning	Discharge Current difference between strings high	BACS has noticed an unusual high current difference within the battery strings during a discharge cycle.	Check Charger and battery string health
BACS String Current Deviation Discharge Warning Off	Discharge Current difference between strings high reset	alarm / warning cleared	For your information.
BACS String Current Deviation Charge Warning	Charge Current difference between strings high	BACS has noticed an unusual high current difference within the battery strings during a charge cycle.	Check Charger and battery string health
BACS String Current Deviation Charge Warning Off	Charge Current difference between strings high reset	alarm / warning cleared	For your information.

FAQ

CS141 FAQ-Frequently asked questions

There is a strange number, ...

What does code 400 (Invalid Handle) / 420 (Failed)/ 522 mean?

This problem can occur if the firmware has been updated but the browser still has old data stored in the cache. Press CTRL + F5 or delete the cache. Restart the WEBMANAGER.

What does code 401 (Access Denied) mean?

"The way is shut. It was made by those who are Dead, and the Dead keep it, until the time comes. The way is shut."
Mostly you need to check your password or user name.

What does code 403 (Forbidden) mean?

The user role does not provide the required access rights for this setting or service.

What does code 404 (Not found) mean?

The requested data point could not be processed because the destination was not found..

What does code 415 (No Interface) mean?

The request is generally valid, but is not supported "as is", e.g. because it has been switched off by a setting.

What does code 422 (Invalid Argument) mean?

This error occurs when trying to adapt the configuration of newer firmware versions with an older firmware. Update to the latest firmware version.

What does code 423 (Pending)?

The requested resource is temporarily blocked. It should be available again in a few minutes. In most cases, a service (restarts) in the background.

What does code 500 / 503 (Service Unavailable) mean?

This code occurs when the web server or a service is heavily occupied for some reason, had to restart or similar. If the problem persists after a few minutes or a restart of the adapter, the firmware must be updated / re-installed. This is recommended in conjunction with a factory reset.

What does code 501 (Not Implemented) mean?

There are two possibilities right here. Either the device is so busy that the function cannot be called, or the request was so surprisingly "different" that there is no function for it.

What does code 520 (Unexpected) mean?

There should have been a specific value in a request / response, but there was not.

The UPS status shows „Paused“.

When CS141 accesses the Alert History of the UPS, the normal connection must be temporarily stopped. By switching to another page inside CS141 menu and pressing F5 to restore the display status (if not done automatically) this should be fixed.

What does issue -1 mean?

This error occurs if no connection to CS141 is currently possible (CS141 reboots, network lost, etc.), but the user tries to access configuration screen. In this case the browser uses cached data to show the screen without the possibility to enter values. In case of a reboot just give the CS141 a little bit more time.

A little bit awkward, but I forgot my password...

This happens to everyone now and then. Take a look at the "Rescue system" chapter - this might help you. If not, contact support@generex.de and we want to find a way to help you.

Why am I logged out when I disable the http tooltips?

Because the tooltips are related to the http service. Changing some values need to redirect the user after restarting the built-in http service.

The CON_R_AUX does not establish a connection!

Copyright of the European Union is effective (Copyright EU) (c) 2024 GENEREX Systems GmbH, Hamburg, Germany. All rights reserved
TEL +49(40)22692910 - EMAIL generex@generex.de - WEB www.generex.de (This and all other product datasheets are available for download.)

This device is not supported by the CS141. You need to use the CON_R_AUX4.

I have entries in the log file called "UPSMAN started"

This entry is generated whenever there was a change in the event configuration: Because the changes are applied immediately, the "UPSMAN service" must be restarted - this will be protocolled.

When accessing the Alert History, I only get an error!

Maybe this function is not supported by the selected UPS. The fact the CS141 supports your UPS does not mean, your UPS supports all function available at the CS141 for this UPS. This is a little bit complicated to explain: sometimes the UPS should support a command, but ignores it consequently.

I get the error "Backend busy" when I try to log in!

Please wait a moment and try again with another browser. If the problem persists after 5 minutes, use the / reboot function. Refer the chapter If nothing works ...

Does the CS141 supports SNMP v1 queries?

Maybe ... yes or no ...

The CS141 has never or will officially support SNMP queries v1.0. On the other hand, it does not mean that it can not if you wish to do that. The only issue that might prevent you using the CS141 the way you want: Due to the fact this is officially not supported, there will be no official bug fix if you have problems. Inofficially maybe our developers can do something if they know somethings not working as it should ...

I have questions that are not explained in the manual.

We always strive to improve our documentation. If you have something that is not or insufficiently explained, please send us a short message to support@generex.de - We are happy to help you as fast as possible.

Q: Why the GX_R_AUX need to be in it's own string:

In principle, you can put the GX_R_AUX directly into a BACS bus, it would work too. However, in larger installations with many BACS modules in one string, this could be a problem:

Each BACS module has a galvanic isolation between the control and the communication module. The communication module is supplied with the necessary operating voltage by the BACS bus. However, the GX_R_AUX requires more power than the BACS modules, which could cause communication problems inside the complete string. The limit of installed modules before this occurs is fluent and depends heavily on where insed the string you placed the GX_R_AUX during installation. Therefore, this type of installation is only conditionally recommendable.

Q I habe 34 BACS modules and unfortunately 38 batteries... Can I just set up 34 batteries?

Well... in the end, yes, BACS will monitor and equalyize 34 batteries. The last 4 batteries will be just loaded. But this is not recommendable. It will lead into problems with the 4 batteries left:

- No monitoring
- No battery management

The problem is normally not that you can add 4 modules later, the problem is, if BACS is running and working, you may forget to add the last 4 batteries.

Q: I was able to reset the BACS module to ID 0 on older systems by pressing the button for 10-15 seconds.

Yes, that is correct, and in older manuals or early quickstarts, you will also find the reference to this function... Resetting a BACS module always became interesting when for some reason a module was not registered correctly or need to reseted by work flow, e.g., if you wanted to reset it specifically for internal spare part delivery or something like that.

Since the technology behind the BACS modules has evolved, this is no longer available for newer installations. For the hardware revisions

- o C20 HW 3.x, FW 3.4.1
- o C30 & C40 HW 3.x with FW 3.4.2 onwards

this BACS module function is no longer available, the reset to 0 can only be carried out via the BACS Programmer.

Q: Do I actually have to disconnect the entire system to replace single BACS modules?

No, you don't have to:

Every BACS module has the ID 0 ex works (unless explicitly ordered with a pre-defined ID) - If you connect the module directly in the BACS bus, you can set the ID 0 to the desired ID with the Single Programming Mode from the BACS Webmanager.

You only have to take care that the exchange of a module is exclusive, and if you have more than one module, you are allowed to connect one module after the other:

Ignoring this will create duplicates. the BACS Programmer will set all modules with the ID 0 to the same target ID (in this example case 15) and thus prevent starting BACS caused by a misconfiguration.

Q: I want to use LDAP with my CS141 – but I cannot find according configuration menus

Yes, because a native LDAP configuration menu does simply not exist and there is no plan for it. But this does not mean there is no method to use a CS141 and LDAP:

Historically, RADIUS servers checked the user's information against a locally stored flat file database. Modern RADIUS servers can do this, or can refer to external sources - commonly SQL, Kerberos, LDAP, or Active Directory servers—to verify the user's credentials. This means:

With firmware 2.02 onwards:

- just configure the CS141 to refer to a RADIUS server to process the user access authentication
- and configure the RADIUS server to use LDAP

Q: Why does my CS141 does not use a GOOGLE Mail account, the login data are correct!?

This can be caused by very different reasons. In addition to the classics of problems like blocked ports, firewall settings, missing routes, missing DNS lookup, etc., it simply cannot work because the mail provider does not want it. Large mail providers are not so greatful an account is used to send fully automatically generated mails, because of producing mail traffic from forgotten devices and randomly addressed SPAM messages in addition to desired status reports. Due to this reason, mail provider uses very different strategies to avoid unwanted mail traffic:

At GOOGLE, for example, a new sender must be actively authorized as a sender by the account user before an email is accepted and forwarded. A re-configuration can also happen in case of the IP address of the accessing device is suddenly on the other side of the world.

Depending on the account status, GOOGLE may ask to verify the access - if configured by push message or SMS:

(Taken by GOOGLE FAQ 2022): You sign up and we like to verify your identity

Sometimes we ask you for an additional registration step, e.g.

- if you log in from a different location than usual or
- when you use a device to log in for the first time.

This additional step may involve entering a confirmation code that we will send to your smartphone via SMS beforehand.

GOOGLE uses this mechanism to check the authenticity and validity of a device that holds correct login data.

By the way... :

Other mail providers have switched to generally blocking automatically generated mails or deactivating the mail account if the mail behavior through a device meets certain criteria, or reject automatic status mails as inadmissible, refer to special release functions, etc.

If in doubt, contact the support of your mail provider or test another mail provider.

FAQ's zu BACS - Modulen*Which BACS topologies are possible?*

This question is a little more complicated to answer because BACS is a real BUS system and, of course, cannot produce any network short circuit. Just don't confuse the difference between a Local Area Network (LAN) and a BACS bus.

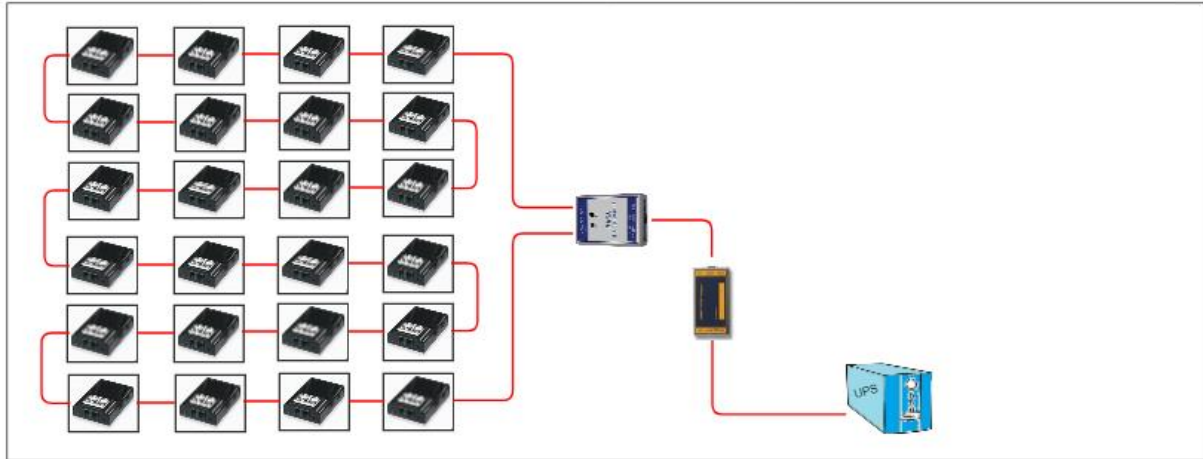
The ring cabling

From a physical and logical perspective, all modules are connected to form a ring, with the BCS Bus Converter defining the beginning and end. With this cabling, the data signal can be sent in both directions, meaning that all modules remain accessible in the event of interference on one cable. The entire system continues to be fully functional despite the malfunction. The downside is in the details: Unfortunately, a ring can be more susceptible to EMI (Electromagnetic Interference) overall because the structure can also act as an antenna.

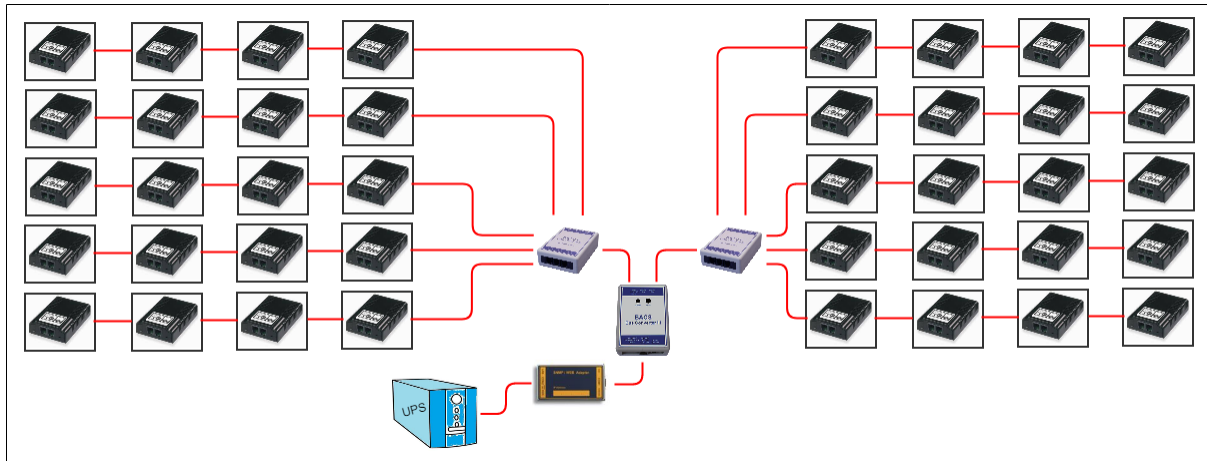
The tree or star wiring:

Essentially, you can recognize a tree topology by the stricter hierarchy - within the tree topology there is always an uplink to a higher-level system, whereas the star is more focused on a clear structure in the cabling. Whether it is a tree or a star is fluid at this point and depends largely on the consideration or the logical association in connection with other network devices. Both BUS and ring cabling can be used

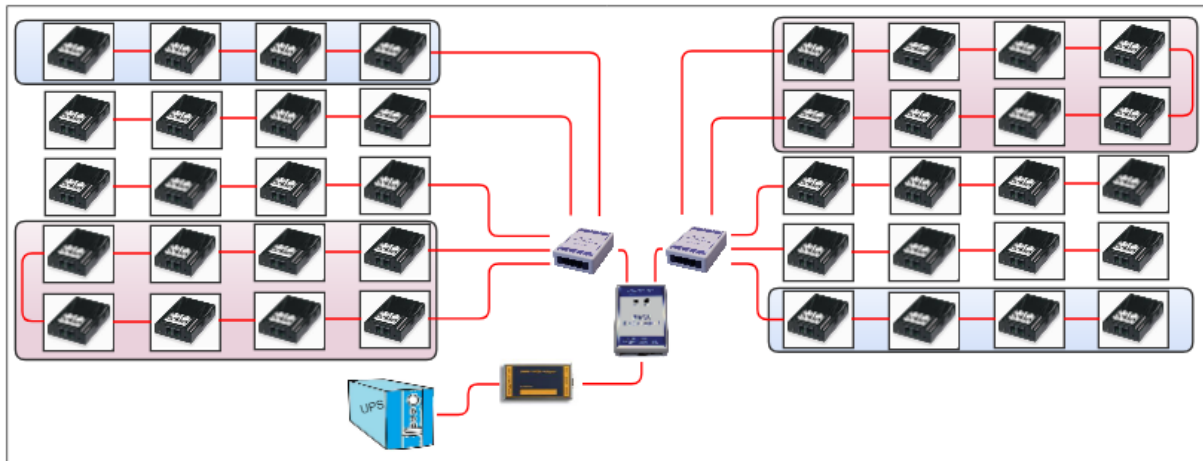
Mixed wiring

A special feature of BACS cabling is that no matter what constellation it is set up, no network short circuit can occur: The BACS web manager organizes the entire BACS data traffic within its own cabling and offers the collected data via a LAN connection via TCP/IP or Modbus to higher-level systems.

Since each BACS module is assigned a unique number, it can always be clearly identified and assigned accordingly.

Note:

Include local conditions in your wiring concepts, as these can play a very important role in later operation, for example if sources of interference arise.

In older systems I was able to reset the BACS module to ID 0 by pressing the button for 10-15 seconds

Yes, that is correct, and you will also find reference to this in older instructions or quickstarts...

This always became interesting when, for some reason, a module was not registered correctly and you wanted to specifically reset it to delivery. As the technology behind the BACS modules has evolved, this is no longer necessary for newer systems. For the hardware revisions

- o C20 HW 3.x, FW 3.4.1
- o C30 & C40 HW 3.x from FW 3.4.2

If this BACS module function is no longer available, the reset to 0 is carried out exclusively via the BACS programmer or the BACS web manager.

My BACS systems all have different BACS module versions, which ones are compatible with each other?

The compatibility of BACS modules always refers to the version number BEFORE the ".": If modules from version 3.0 - 3.5 are used in your systems, in the event of defects you can replace the defective module with any replacement module from the 3 series. Please note, however, that some functions may be omitted or added, e.g. the receive line check has been omitted from module version 3.4 as it is no longer technically necessary.

Do not try the combination 2.x (or older) > 3.x, it will not work. BACS will show the error message *calibration / hardware version mismatch* when starting BACS.

P.S. For this reason, you will also receive a module with firmware 3.5 (or higher, if technically feasible) as a spare part for your 3.x systems, even though you have expressly ordered a module with version 3.3.

Do I actually have to disassemble the entire system to replace a BACS module?

No, you don't have to:

A BACS module spare part normally uses the factory ID 0 on delivery (unless exclusively ordered pre-configured) - If you connect the module directly to the BACS bus, you can set ID 0 to the BACS web manager using the single programming mode set the desired ID. You just have to note that the exchange of a module is exclusive, and in the case of several modules, one module after the other may only be connected and configured:

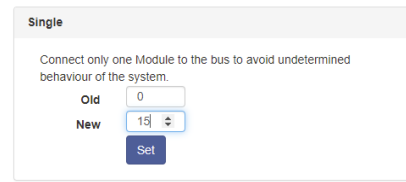

Otherwise, the BACS programmer will assign all modules with ID 0 to the same target ID (in this case 15) and thus create doublets, which means that the BACS bus will no longer start.

BACS-Module, Hardwareversion 3:

Why do some systems show the total voltage of the BACS strings and others not??

For this function you need BACS modules with hardware version 3.0 or higher. Existing systems with older modules cannot provide this function:

18	13.58	30.0	31.75	100%	100%	38	13.58	32.0	20.16	100%	100%	58	13.58	30.0	15.36	100%	100%	78	13.65	30.5	55.69	100%	100%
19	13.58	29.5	30.29	100%	100%	39	13.58	28.9	20.38	100%	100%	59	13.58	29.5	31.58	100%	100%	79	13.65	29.1	30.60	100%	100%
20	13.58	29.5	29.88	100%	100%	40	13.58	30.0	15.62	100%	100%	60	13.58	29.3	14.30	100%	100%	80	13.65	29.2	31.61	100%	100%
Σ Voltage 271.63 V				Σ Voltage 271.62 V				Σ Voltage 271.60 V				Σ Voltage 273.06 V											
13.58 [V] Target Voltage				13.58 [V] Target Voltage				13.58 [V] Target Voltage				13.65 [V] Target Voltage											
0 [A] DC Current 0.00 [KW] Real Power				0 [A] DC Current 0.00 [KW] Real Power				0 [A] DC Current 0.00 [KW] Real Power				0 [A] DC Current 0.00 [KW] Real Power											
0 [A] AC Current				0 [A] AC Current				0 [A] AC Current				0 [A] AC Current											
Module info		Battery info		Contact info		Level Info		Miscellaneous															
Module type	C20	Manufacturer	Various Vendors 2014-2019	Contact Person		Voltage Low/High	10.5 V/14.9 V	Firmware Version	2.16.12 230714														
Hardware Version	03.0	Type	7Ah VRLA	Phone Number		Temperature Low/High	5°C/50°C	Discharge Counter	13														
Software	03.04.00	Capacity(C10)	155 Ah	IP Address	1	Resistance Min/Max (Average)	1.2 mΩ/59 mΩ (0)	Ripple Voltage	0 mV														

To figure out the hardwareversion that is currently in use, just take a look at Module info: The current BACS-Module hardware version is listed at „Hardware Version“.

If you would like to update your existing system on the hardware side, we recommend contacting technical support regarding reusable and compatible parts at support@generex.de.

For further questions please contact our support at support@generex.de!

Appendix:**CS141 Hardening Guide**

Each product of the CS141 product family (CS141/HW161 WEBMANAGER, SITEMANAGAER and -MONITOR 6, BACSKIT B4) provides numerous functions coming with "out of the box" settings and standardized configuration when delivered:

- Predefined and generally valid ports
- Pre-installed certificates, if possible
- Quickly configured web access
- Commonly known default passwords
- Standard community names (for example. "public" or "private" for SNMP)
- And much more ...

Due to this fact, it is possible to put these devices into operation and integrate them into an existing network in a short time and, above all, without in-depth knowledge of network and system administration, as long as generally accepted conventions for a network infrastructure are met.

However, standardized out-of-the-box configurations also have the disadvantage that a network-compatible device, regardless of the manufacturer or its function, cannot be operated as "network security approved" in terms of cybersecurity, if only a glance at the manufacturer's manual can reveal many interesting features that can be used to eavesdrop on or even infiltrate a network.

This chapter shall show how to harden the settings of a CS141 Webmanager Device.

Note:

This Hardening Guide describes, among other things, how you can adjust ports - before making changes, be sure to check whether the ports you want are both free and available, otherwise you risk communication problems. Please note that port changes must be implemented network-wide depending on the intended use.

Not ALL of the options or "recommended settings" presented here are necessarily compatible with your network or can be implemented on site 1:1 within local IT security guidelines. Refer to the responsible system administrator or administrator beforehand!

GENERAL RECOMMENDATIONS:

1. Change your passwords regularly
2. Store your system backups secured and deny unauthorized access
3. Keep an eye on the validity of the certificates used
4. use the latest firmware or check regularly if new firmware versions provide
5. improvements and new security options.

Part 1: How to secure the user management

All devices of the CS141 - product family offer 2 basic login methods, which can be combined if desired. Both methods have their respective advantages and disadvantages

Local user management:

The CS141 distinguishes between the user name and the "user role". The only user that is preset on the hardware side and cannot be deactivated is the user "admin" with the user role "Super User":

All other users can be changed, adjusted and deleted:

Security recommendation:

1. Change the password for the super user "admin" to block the default administrative access. The basic rule for a secure password is :
 - Approx. 8-16 characters
 - Upper and lower case
 - numbers
 - Special characters

Click on "Edit user" at "admin":

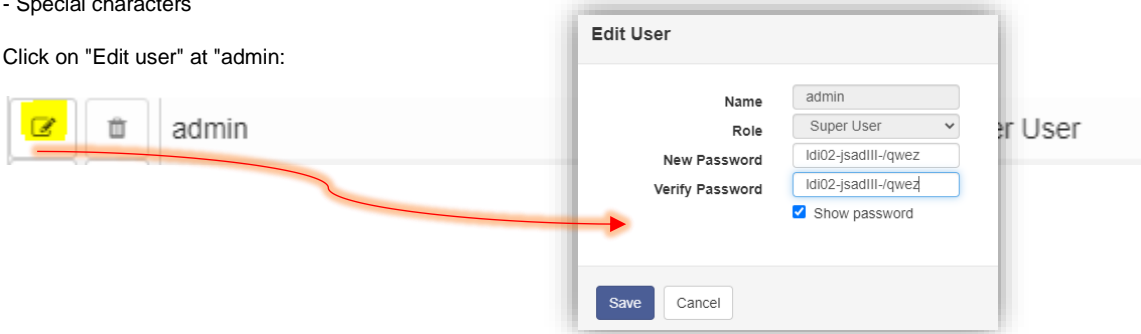

This is the first step towards operational security; only the user "admin" with a cryptic password is active and can log on to the device.

2. Disable all user roles you do not need:

Once disabled, a user who has been assigned this role can no longer log in.

Special function: Allow Anonymous Guest

This function is deactivated by default. The anonymous guest is only required if you use a UNMS 2 or have implemented direct displays of the monitoring screens, e.g. with an iFrame or similar.

<input checked="" type="radio"/> Local Authentication Only <input type="radio"/> RADIUS, then Local Authentication <input type="radio"/> RADIUS Only	<input checked="" type="checkbox"/> Lock the Engineer Role <input checked="" type="checkbox"/> Lock the Customer Role <input checked="" type="checkbox"/> Lock the Guest Role <input type="checkbox"/> Allow Anonymous Guests
--	--

Note:
 A user with the user role "Guest" is sufficient to take a "look" at the UPS screens. The user "Customer" may download log files in addition to "Looking", but nothing else.

3. Delete or edit default user names and passwords

		Name	Role
		admin	Super User
		engineer	Engineer
		customer	Customer
		guest	Guest

Change both, the name and password for the factory default users "engineer", "customer" and "guest".

Network managed user management

From firmware 2.04, all units of the CS141 product family offer the option to hand over the user management to a RADIUS server. By doing so, there are 2 different security concepts:

Access-optimised security: RADIUS, then local user authentication

In this mode, user access is managed exclusively via a RADIUS server as long as a pre-defined RADIUS is available. If the RADIUS server does not respond, it is possible to log in via locally managed user - access to the configuration menus is guaranteed at all times.

Security recommendation:

1. Disable the unnecessary user roles.
Unnecessary user roles distributed by the RADIUS server are then rejected by the CS141
2. Edit or delete pre-defined user names (change password and user name).
In case of a RADIUS server is not available, the local user database is automatically active.
3. Enable the function RADIUS then Local Authentication .

Note:

Remember to change the local stored passwords regularly.

Cyber-security-optimised security: Exclusive RADIUS mode

With this operating mode, the local user database is completely disabled when in normal operating mode- The user management is exclusively served by a RADIUS server. If local access is needed, the slide be switched to centre position (configuration mode) and the CS141 needs to restart on site.

Recommendation:

1. The local user management settings are identical to "RADIUS than local".
2. Enable RADIUS Only.

Note:

The advantage of exclusive RADIUS login is that it is possible to manage both, usernames and passwords directly via a central server. If the RADIUS server is not accessible, no user can log in. Local access requires presence on site.

RADIUS - R802.1X Port Access

At System>Security, you will also find the option to activate access via R802.1X as access control. In this case, access is controlled via the port of the network switch and its configuration.

All encryption methods and authentication methods offered at the current status (April / 2022) are considered "secure". If there are new methods, they will be updated accordingly.

Recommendation: If R802.1X is in use, enable this function.

Part 2: System and services

General service operation

Unnecessarily running system services may not necessarily be a gateway for hackers, but they are a latent danger because of the possibility of intercepting data traffic to evaluate points of interest within a network.

Recommendation to increase security

Disable all services you do not need to run.

SNMP Agent	<input type="checkbox"/> Off	Web Server	<input checked="" type="checkbox"/>
Modbus Slave	<input type="checkbox"/> Off	UNMS & RCCMD Trap Service	<input type="checkbox"/> Off
BACnet Server	<input type="checkbox"/> Off	Rsyslog Client	<input type="checkbox"/> Off
Serial Trace	<input type="checkbox"/> Off		

Apply Cancel

The fewer system services that require communication run on a network, the less data traffic can be intercepted.

Services in detail

The Email Client

For maximum security, we recommend using an internal mail server to prevent status messages from being processed and tracked by 3rd party service providers. For the CS141, we recommend using TLS/SSL to directly encrypt the communication between the CS141 and the mail server.

Services > EMail

Mail Server	mail.waddehaddedededa.de
SMTP Port	587
Connection Security	TLS/SSL
Sender EMail Address	stefan@waddehaddedededa.de
Use EMail Authentication	<input checked="" type="checkbox"/>
Username	stefan
Password
Verify Password

Email Traps

This function is only needed in case of a UNMS with email traps is in use, and receiving trap messages via email is wanted. In all other operating scenarios, you can "switch off" the mail traps by removing the tick.

Mail-Traps recommendation:

The screenshot shows a configuration window for email traps. At the top, there is a yellow bar with the text "Enable EMail-Traps" and a checked checkbox. A red arrow points to the checkbox. To the right of this bar is a button labeled "Copy from EMail". Below the bar, there are several input fields: "Mail Server" (empty), "SMTP Port" (587), "Connection Security" (STARTTLS), "Sender Email Address" (empty), "Use EMail Authentication" (checked), and "Username" (empty).

Disable email traps if you do not use UNMS. Without UNMS, the data are useless.

The SNMP Agent

With SNMP (Simple Network Management Protocol), all devices of the CS141 product family offer a standardised and popular option for integration into building management systems. Versions 2 and 3 differ in terms of access security as well as the access concept.

Maximum security

For maximum security, we recommend the SNMP agent configured to use **version 3**, **permission to "Read only"**.

SNMP v3 offers a user-based access procedure, where you can freely define secure passwords.

All offered methods for securing data traffic are considered to be "secure" at the current state of the art (April 2022), but we recommend the combination SHA / AES here because these use the more modern methods for encryption.

Please note: MD5 / SHA or DES / AES are not cross compatible. Which method you have to use therefore depends on the network in which you want to operate the CS141.

If you need to use SNMP v2

SNMP v2 uses community based communication options. In addition, pre-defined IP addresses can be used to restrict general access to some devices

Recommended settings:

The screenshot shows the "Add User" configuration window. It contains the following fields: "User" (Jean-Luc), "Permission" (Read only), "Security Level" (Authenticat), "Algorithm" (SHA selected), "Password" (masked), "Privacy Algorithm" (AES selected), and "Privacy Password" (masked). At the bottom, there are "Cancel" and "Save" buttons.

1. Change the community names (default "public" for reading and "private" for writing)
2. Use the IP address settings to define which users are authorized to receive data.
3. Set the permission to "read only".

Modbus over TCP / IP

For many years, Modbus can also be queried via TCP, which offers numerous possibilities to connect a device of the CS141 product family to a building management system to query status messages.

This can be used to obtain a lot of interesting information about the operating status of infrastructural systems such as UPS systems or batteries.

Port P502 is used as a well-known standard.

Recommendation: Switch to another port

Port P502 is a default setting, and many devices use it for Modbus, if you change the port you make it more difficult for not authorized persons and network intruders to find.

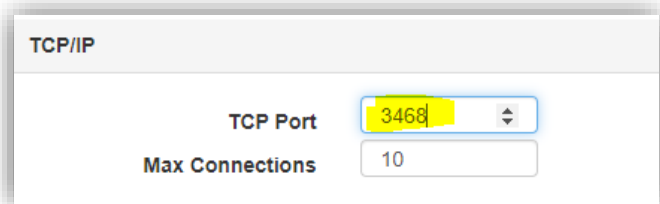
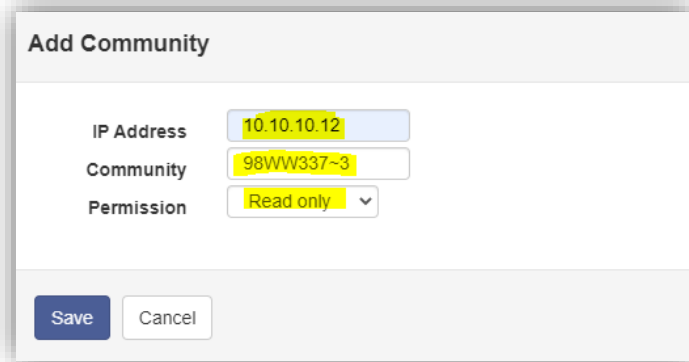

RCCMD

RCCMD (Remote Control and Command) is in itself a very secure method to inform and manage target systems in case of an upcoming incident, and, if necessary, shutting them down automatically.

Normally, RCCMD operates passively in the background and will not produce any pointless data traffic that could be intercepted. The security thus provided by the operating mode alone is sufficient in most networks, but can be sharpened.

Recommendation for increasing security:

1. Allow TLS connections only
2. Reject expired certificates
3. Use your own certificate.

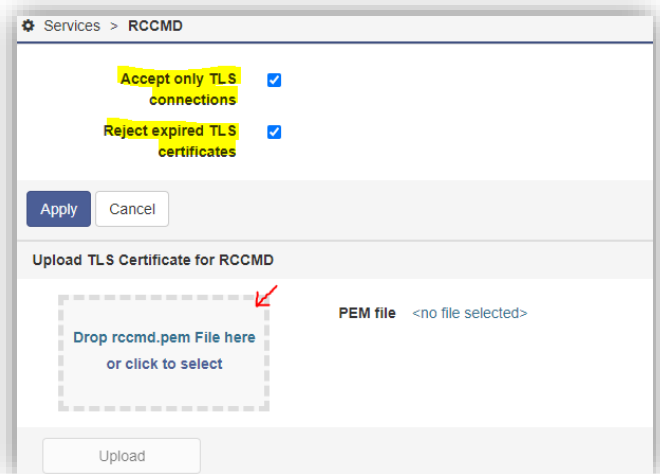

Webserver

All devices of the CS141 product family have a modern web interface with a specially hardened web server running in the background. In addition to the configuration interface, the available monitoring screens are also provided via the integrated web server module.

Recommendation to sharpen security

1. Enable force https
This deactivates the standard method via http and the communication runs exclusively via the encrypted communication type https.
2. Replace the default TLS certificate and use your own certificates

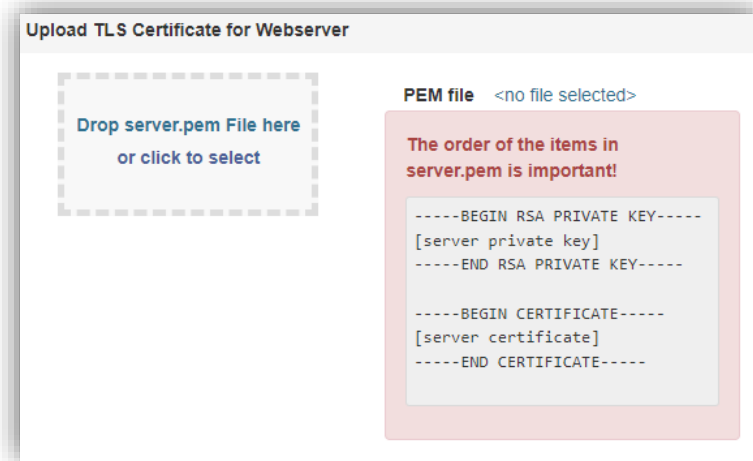

3. Change the ports the web server answers by default. By default, the web interface is called on port 80 and port 443. Reduce the time window for the auto logout to a minimum in order to automatically log users out of the CS141.as

quickly as possible in case of inactivity.

Remote Syslog

By default, the Remote Syslog Client runs with port 601 with a pre-installed certificate.

This service aims to store locally saved log files centrally copy directly on a network node, where automatic diagnostic tools can carry out numerous evaluations.

Recommendation to sharpen security

1. Only activate this function if you are using a syslog receiver in the network.
2. Enable "Accept only TLS connections".
3. Enable „Reject expired TLS certificates“
4. Use another Remote Syslog port than the default port 601

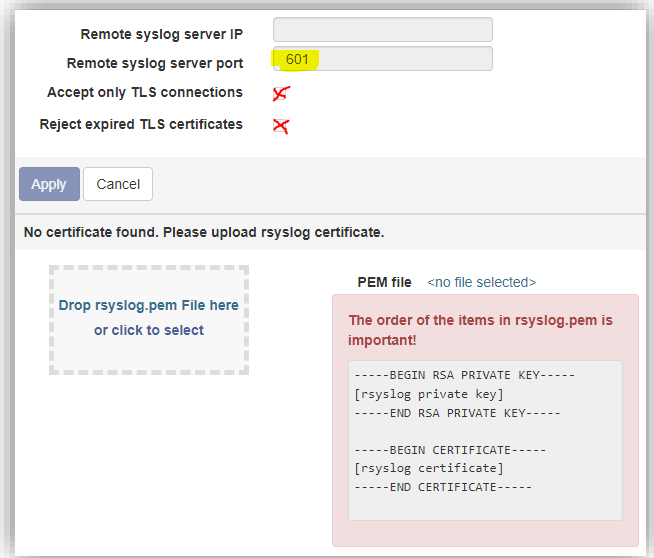

Locking up the CS141 to exclude manipulation attempts via the web server - The fully autonomous mode.

This solution is useful if a CS141-based device operates within particularly exposed and vulnerable installations.

All devices of the CS141 product family offer the function to completely "lock" a device and to prohibit further access to the configuration interface. Internal watchdogs take over the task of restarting individual services or, if necessary, the entire device. In this case, the device runs 100% autonomously "as configured" - but can no longer be comfortably reconfigured. Please ensure all configuration work is done before entering the full autonomous mode.

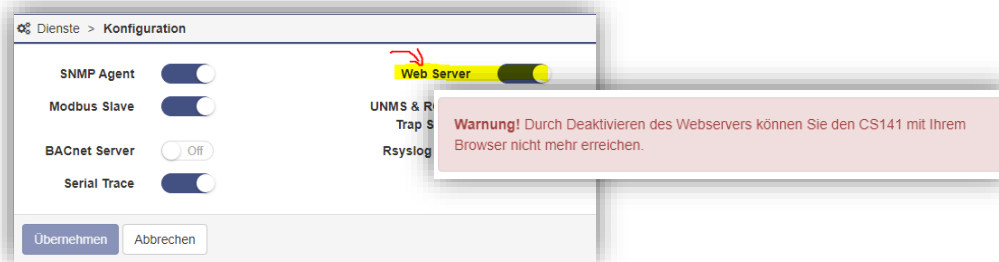

With this configuration, any access is rejected - therefore persons are pro-active prevented in trying to manipulate system settings, for example, to specifically sabotage important settings in emergency management or hijack mail services for logical spam bombs.

To use this mode, we recommend to create a BACKUP file!

This mode can only be ended by resetting the device to factory mode and deleting the entire configuration. That's why we recommend to create a backup before entering the autonomous mode by disabling the internal web server. Fast configuration changes can only be carried out with resetting to factory default, restoring the configuration from a backup, doing the configuration changes, and finally creating a new backup:

1. Move the slide switch to the centre position (configuration mode) and restart the CS141.
2. Open a web browser and type 10.10.10.10/ update to open the update routine.
3. Flash the Firmware, remember to enable factory default settings
4. After update, open the backup function and upload your backup file.
5. Do your configuration work.
6. Move the slide switch back to the desired position.
7. Test your settings and changes.
8. Create a new backup file
9. Disable the web server device

Even the web server will not provide a configuration interface, the firmware update service is still available to force a system reset with the local superuser "admin".

Note:

Where do I find the latest firmware?

The latest firmware is available free of charge at the download portal of www.generex.de .

Hardware Layout CS141

1. Slide-Switch for network configuration
2. Network Interface
3. COM2 MINIDIN Connector for RS232
4. COM2 Phoenix Connector for RS485
5. Green and Red Status LED
6. AUX Interface
7. PoE Header
8. Debug Adapter
9. Rescue Jumper: Open = Normal Boot, Close = Rescue Boot
10. NAND Flash
11. CPU
12. RAM
13. USB Interface
14. COM1
15. Slot Interface
16. Power Supply
17. DIP Switch
18. Fuse

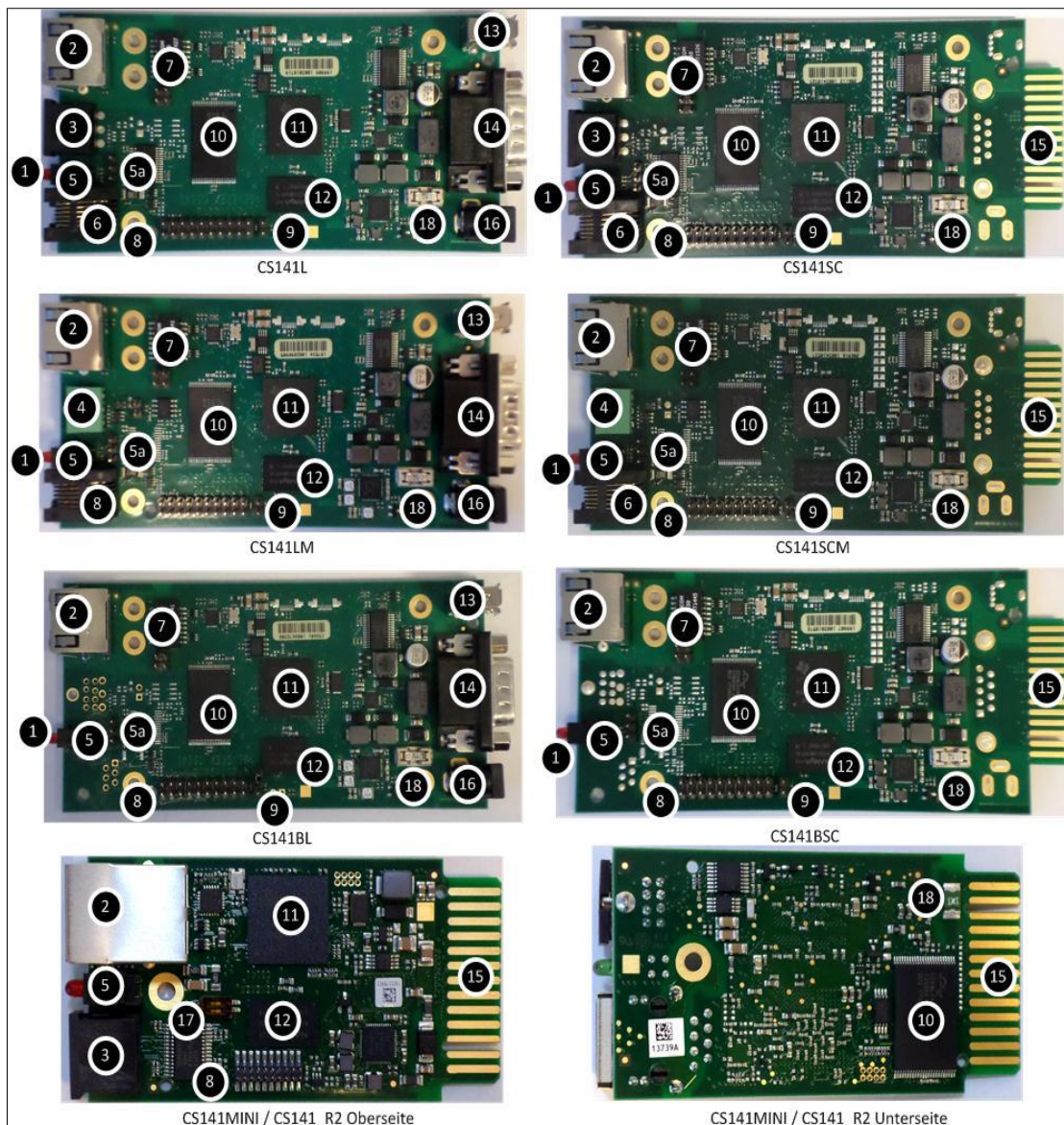

Interface Description

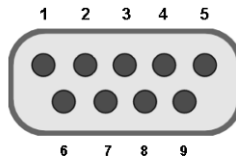

External D-SUB 9-polig male

Pin1:	DCD	Pin6:	DSR
Pin2:	RxD	Pin7:	RTS
Pin3:	TxD	Pin8:	CTS
Pin4:	DTR	Pin9:	RI
Pin5:	GND		

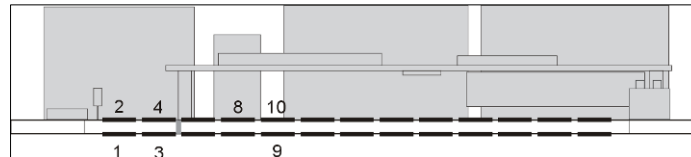

Slot version: Circuit board connection

Pin	Signal name	Level	Function
1	GND		Power Ground
2	8 – 34V DC		Power Input
3	COM1 TXD	V24	COM1 Transmit Data
4	COM1 RXD	V24	COM1 Receive Data
5	SW_GPIO_1 1) 2)	3,3V TTL	CS141DMINI: Functionality of DIP-Switch 1
6	SW_GPIO_2 1) 2)	3,3V TTL	CS141DMINI: Functionality of DIP-Switch 2
7	POW# Input 1)	3,3V TTL	Enable power supply (active low)
8	Bridged with Pin 10		
9	GND		Signal Ground
10	Bridged with Pin 8		
11	COM1 DTR 1)	V24	COM1 Data Transmit Ready
12	COM1 RI 1)	V24	COM1 Ring Indicator
13	COM3 RXD 1) 2)	5V TTL	COM3 Receive Data
14	COM3 TXD 1) 2)	5V TTL	COM3 Transmit Data
15	COM2 TXD 1) 2)	3,3V TTL	COM2 Transmit Data
16	COM2 RXD 1) 2)	3,3V TTL	COM2 Receive Data
17-26	-		n.c.

1) Connectable with solder bridge (MINI: resistor bridge)

2) Input with Pull-Up

Differences to the CS121

- Complete rework of the menu structure: The simplified interface combines a powerful hardware to provide a significant performance boost:
- The powerful successor of the CS121 allows configuration in real-time - necessary system services will be started or stopped as needed. Therefore, a restart is only necessary in exceptional situations.
- Additional hardcoded user accounts according to specialized tasks:
- Engineer and Guest accounts are provided according to their tasks with limited system rights. On request the new guest account can be set up to allow external technicians a quick information overview without the need of password entry.
- The DIP switches known from the CS121 are no longer required and changed by a comfortable slide switch in the front of the device:

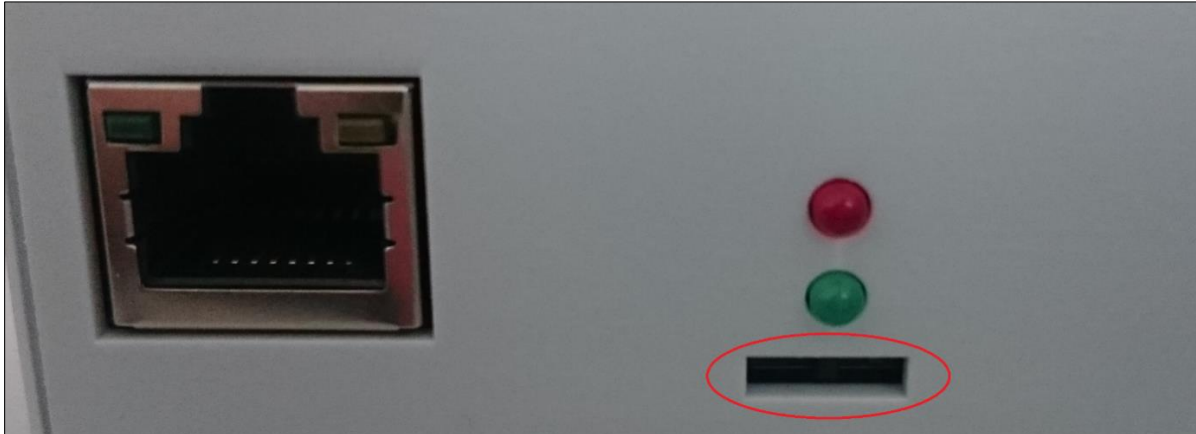

The easy-to-use slide switch will change the hardware configuration. Once the configuration state is chosen, a reboot can be done by the removing power connection or software triggered.

- The firmware update can now be carried out inside a common browser via drag & drop. The need for external tools and FTP access is no longer necessary.
- In case of problems with the firmware, updates or reboots can also be carried out without a complete login. To do this, use a common web browser and enter the IP of the device followed by /update. After a successful admin authentication, the firmware can now be updated and optionally reset to factory settings.
- By default, auto logout is now enabled. On inactivity, the user is logged out of the system after 15 minutes.
- The power consumption of the CS141 has been reduced by a factor of 10 with a power increase and is well below the predecessor model.

Note:

The CS121 has been discontinued in 2015 and replaced by the powerful successor CS141. The Software development was officially discontinued in 2018 - the current firmware state is frozen. Newer UPS systems and models are not available. If you use a CS121 with a specific UPS manufacturer for many years, it may happen that your new UPS model is not natively available even if you use the latest firmware version.

In this case, it is advisable to move to the successor CS14.

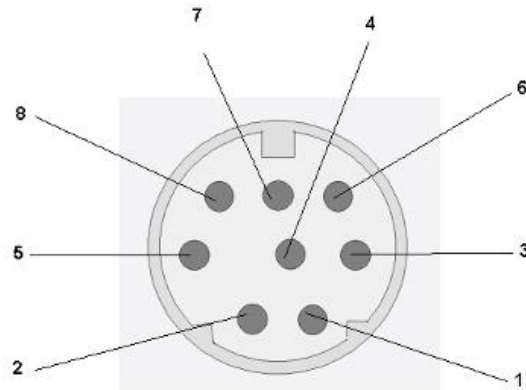
Pin COM2 Mini-DIN 8 pol**Mini DIN 8 socket RS-232:**

Pin1: -> DCD
 Pin2: -> RxD
 Pin3: -> TxD
 Pin4: -> DTR
 Pin5: -> DSR
 Pin6: -> RTS
 Pin7: -> CTS
 Pin8: -> RI
 shield -> GND

RS-485 (optional):

Pin1 -> GND
 Pin2 -> RS485/A
 Pin3 -> RS485/B(-)

AUX-Port (Hardware Revision 1.1 = from Serial numbers 0121-1203, 0122-00198, 0123-00564 onwards) RJ11 6-pol

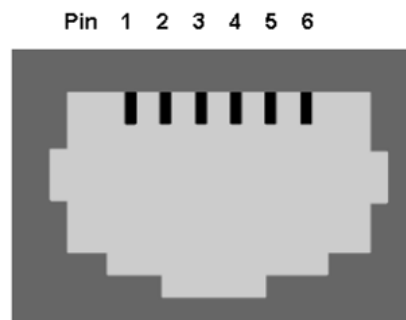

Pin1: -> +5V
 Pin2: -> RxD (COM 2 Input) CS141MINI-6 only
 Pin3: -> TxD (COM2 Output) CS141MINI-6 only
 Pin4: -> RxD (COM3 Input)
 Pin5: -> TxD (COM3 Output)
 Pin6: -> GND

Modbus addresses

OEM MODBUS Defaultadress (for all products/OEMS, not specified further down in this modbus manual)

Address	Type	Function	Name	Description	Length
97	U	3 / 4	OUTPUT_VOLT0	Output Voltage Phase 1 in V	1
98	U	3 / 4	OUTPUT_VOLT1	Output Voltage Phase 2 in V	1
99	U	3 / 4	OUTPUT_VOLT2	Output Voltage Phase 3 in V	1
100	U	3 / 4	OUTPOWER0	Outpower Phase 1 %	1
101	U	3 / 4	OUTPOWER1	Outpower Phase 2 %	1
102	U	3 / 4	OUTPOWER2	Outpower Phase 3 %	1
103	U	3 / 4	BATTCAP	Battery Capacity %	1
104	S	3 / 4	INVOLT0	Input Voltage Phase 1 V	1
105	S	3 / 4	INVOLT1	Input Voltage Phase 2 V	1
106	S	3 / 4	INVOLT2	Input Voltage Phase 3 V	1
107	S	3 / 4	TEMPDEG	Temperature C°	1
108	S	3 / 4	AUTONOMTIME	Autonomy Time minutes	1
109	U	3 / 4	STATUS (e. g. UPS normal = "4", Powerfail = "12", Battery test running = "68", Bypass = "5")	UPS Status (ASCII HEX) Please note UPSMAN status bytes table below	1
110	S	3 / 4	BATTVOLT	Battery Voltage V	1
111	U	3 / 4	INFREQ0	Input Frequency Hz Phase 1	1

112	U	3 / 4	INFREQ1	Input Frequency Hz Phase 2	1
113	U	3 / 4	INFREQ2	Input Frequency Hz Phase 3	1
114	U	3 / 4	CNT_PF	Powerfail Counter	1
115	U	3 / 4	Alarm Battery Bad	1 = active; 0 = not active	1
116	U	3 / 4	Alarm: On Battery	1 = active; 0 = not active	1
117	U	3 / 4	Alarm: Battery Low	1 = active; 0 = not active	1
118	U	3 / 4	Alarm: Battery Depleted	1 = active; 0 = not active	1
119	U	3 / 4	Alarm: Over temperature	1 = active; 0 = not active	1
120	U	3 / 4	Alarm: Input Bad	1 = active; 0 = not active	1
121	U	3 / 4	Alarm: Output Bad	1 = active; 0 = not active	1
122	U	3 / 4	Alarm: Output Overload	1 = active; 0 = not active	1
123	U	3 / 4	Alarm: On Bypass	1 = active; 0 = not active	1
124	U	3 / 4	Alarm: Bypass Bad	1 = active; 0 = not active	1
125	U	3 / 4	Alarm: Output Off as requested.	1 = active; 0 = not active	1
126	U	3 / 4	Alarm: UPS Off as requested.	1 = active; 0 = not active	1
127	U	3 / 4	Alarm: Charger Failed	1 = active; 0 = not active	1
128	U	3 / 4	Alarm: UPS Output Off	1 = active; 0 = not active	1
129	U	3 / 4	Alarm: UPS System Off	1 = active; 0 = not active	1
130	U	3 / 4	Alarm: Fan Failure	1 = active; 0 = not active	1
131	U	3 / 4	Alarm: fuse failure	1 = active; 0 = not active	1
132	U	3 / 4	Alarm: general fault	1 = active; 0 = not active	1
133	U	3 / 4	Alarm: diagnose test failed	1 = active; 0 = not active	1
134	U	3 / 4	Alarm: communication lost	1 = active; 0 = not active	1

135	U	3 / 4	Alarm: awaiting power	1 = active; 0 = not active	1
136	U	3 / 4	Alarm: shutdown pending	1 = active; 0 = not active	1
137	U	3 / 4	Alarm: shutdown imminent	1 = active; 0 = not active	1
138	U	3 / 4	Alarm: test in progress	1 = active; 0 = not active	1
139	U	3 / 4	AUX Port 1	1 = active (high), 0 = not active (low)	1
140	U	3 / 4	AUX Port 2	1 = active (high), 0 = not active (low)	1
141	U	3 / 4	AUX Port 3	1 = active (high), 0 = not active (low)	1
142	U	3 / 4	AUX Port 4	1 = active (high), 0 = not active (low)	1
143	U	3 / 4	Sensormanager/SMTCOM sensor 1	Analog value	1
144	U	3 / 4	Sensormanager/SMTHCOM sensor 2	Analog value	1
145	U	3 / 4	Sensormanager sensor 3	Analog value	1
146	U	3 / 4	Sensormanager sensor 4	Analog value	1
147	U	3 / 4	Sensormanager sensor 5	Analog value	1
148	U	3 / 4	Sensormanager sensor 6	Analog value	1
149	U	3 / 4	Sensormanager sensor 7	Analog value	1
150	U	3 / 4	Sensormanager sensor 8	Analog value	1
These are the digital Inputs of a SITEMANAGER/SITEMONITOR: 50000 – 50063					
50000	U	3 / 4	SITEMANAGER/SITEMONITOR Digital Input 1	1 = active (high), 0 = not active (low)	1
50001	U	3 / 4	SITEMANAGER/SITEMONITOR Digital Input 2	1 = active (high), 0 = not active (low)	1
50002	U	3 / 4	SITEMANAGER/SITEMONITOR Digital Input 3	1 = active (high), 0 = not active (low)	1

50003	U	3 / 4	SITEMANAGER/SITEMONITOR Digital Input 4	1 = active (high), 0 = not active (low)
50004	U	3 / 4	SITEMANAGER/SITEMONITOR Digital Input 5	1 = active (high), 0 = not active (low)
50005	U	3 / 4	SITEMANAGER/SITEMONITOR Digital Input 6	1 = active (high), 0 = not active (low)
50006	U	3 / 4	SITEMANAGER/SITEMONITOR Digital Input 7	1 = active (high), 0 = not active (low)
50007	U	3 / 4	SITEMANAGER/SITEMONITOR Digital Input 8	1 = active (high), 0 = not active (low)
50008	U	3 / 4	SITEMONITOR Digital Input 9	1 = active (high), 0 = not active (low)
50009	U	3 / 4	SITEMONITOR Digital Input 10	1 = active (high), 0 = not active (low)
[...] continue until [...]				
500063	U	3 / 4	SITEMONITOR Digital Input 64	1 = active (high), 0 = not active (low)
These are the digital outputs of a SENSORMANAGER/SITEMANAGER: 50064 – 50071				
50064	U	3 / 4	SENSORMANAGER/SITEMANAGER Digital Output 1	1 = active (high), 0 = not active (low)
50065	U	3 / 4	SENSORMANAGER/SITEMANAGER Digital Output 2	1 = active (high), 0 = not active (low)
50066	U	3 / 4	SENSORMANAGER/SITEMANAGER Digital Output 3	1 = active (high), 0 = not active (low)
50067	U	3 / 4	SENSORMANAGER/SITEMANAGER Digital Output 4	1 = active (high), 0 = not active (low)
50068	U	3 / 4	SITEMANAGER Digital Output 5	1 = active (high), 0 = not active (low)
50069	U	3 / 4	SITEMANAGER Digital Output 6	1 = active (high), 0 = not active (low)
50070	U	3 / 4	SITEMANAGER Digital Output 7	1 = active (high), 0 = not active (low)

50071	U	3 / 4	SITEMANAGER Digital Output 8	1 = active (high), 0 = not active (low)
These are the analog inputs of a SM_T_COM/SM_T_H_COM/SENSORMANAGER/SITEMANAGER: 50072 – 50079				
50072	U	3 / 4	SM_T_COM/SM_T_H_COM/SENSORMANAGER/SITEMANAGER Analog Input 1	Analog value 1
50073	U	3 / 4	SM_T_H_COM/SENSORMANAGER/SITEMANAGER Analog Input 2	Analog value 1
50074	U	3 / 4	SENSORMANAGER/SITEMANAGER Analog Input 3	Analog value 1
50075	U	3 / 4	SENSORMANAGER/SITEMANAGER Analog Input 4	Analog value 1
50076	U	3 / 4	SENSORMANAGER/SITEMANAGER Analog Input 5	Analog value 1
50077	U	3 / 4	SENSORMANAGER/SITEMANAGER Analog Input 6	Analog value 1
50078	U	3 / 4	SENSORMANAGER/SITEMANAGER Analog Input 7	Analog value 1
50079	U	3 / 4	SENSORMANAGER/SITEMANAGER Analog Input 8	Analog value 1

Section OEM: ABB/NEOWAVE UPS Type Concept Power

Address	Type	Function	Name	Description	Length
This is the general UPS modbus address list. It uses the address range 100 – 183:					
100	U	3 / 4	OUTPOWER0	Outpower Phase 1 %	1
101	U	3 / 4	OUTPOWER1	Outpower Phase 2 %	1
102	U	3 / 4	OUTPOWER2	Outpower Phase 3 %	1
103	U	3 / 4	BATTCAP	Battery Capacity %	1
104	S	3 / 4	INVOLT0	Input Voltage Phase 1 V	1
105	S	3 / 4	INVOLT1	Input Voltage Phase 2 V	1
106	S	3 / 4	INVOLT2	Input Voltage Phase 3 V	1
107	S	3 / 4	TEMPDEG	Temperature C°	1
108	S	3 / 4	AUTONOMTIME	Autonomy Time minutes	1
109	U	3 / 4	STATUS (e. g. UPS normal = "4", Powerfail = "12", Battery test running = "68", Bypass = "5")	UPS Status (ASCII HEX) Please note UPSMAN status bytes table below	1
110	S	3 / 4	BATTVOLT	Battery Voltage V	1
111	U	3 / 4	INFREQ0	Input Frequency Hz Phase 1	1
112	U	3 / 4	INFREQ1	Input Frequency Hz Phase 2	1
113	U	3 / 4	INFREQ2	Input Frequency Hz Phase 3	1
114	U	3 / 4	CNT_PF	Powerfail Counter	1
115	U	3 / 4	Alarm Battery Bad	1 = active; 0 = not active	1
116	U	3 / 4	Alarm: On Battery	1 = active; 0 = not active	1
117	U	3 / 4	Alarm: Battery Low	1 = active; 0 = not active	1
118	U	3 / 4	Alarm: Battery Depleted	1 = active; 0 = not active	1

Address	Type	Function	Name	Description	Length
119	U	3 / 4	Alarm: Over temperature	1 = active; 0 = not active	1
120	U	3 / 4	Alarm: Input Bad	1 = active; 0 = not active	1
121	U	3 / 4	Alarm: Output Bad	1 = active; 0 = not active	1
122	U	3 / 4	Alarm: Output Overload	1 = active; 0 = not active	1
123	U	3 / 4	Alarm: On Bypass	1 = active; 0 = not active	1
124	U	3 / 4	Alarm: Bypass Bad	1 = active; 0 = not active	1
125	U	3 / 4	Alarm: Output Off as requested.	1 = active; 0 = not active	1
126	U	3 / 4	Alarm: UPS Off as requested.	1 = active; 0 = not active	1
127	U	3 / 4	Alarm: Charger Failed	1 = active; 0 = not active	1
128	U	3 / 4	Alarm: UPS Output Off	1 = active; 0 = not active	1
129	U	3 / 4	Alarm: UPS System Off	1 = active; 0 = not active	1
130	U	3 / 4	Alarm: Fan Failure	1 = active; 0 = not active	1
131	U	3 / 4	Alarm: fuse failure	1 = active; 0 = not active	1
132	U	3 / 4	Alarm: general fault	1 = active; 0 = not active	1
133	U	3 / 4	Alarm: diagnose test failed	1 = active; 0 = not active	1
134	U	3 / 4	Alarm: communication lost	1 = active; 0 = not active	1
135	U	3 / 4	Alarm: awaiting power	1 = active; 0 = not active	1
136	U	3 / 4	Alarm: shutdown pending	1 = active; 0 = not active	1
137	U	3 / 4	Alarm: shutdown imminent	1 = active; 0 = not active	1
138	U	3 / 4	Alarm: test in progress	1 = active; 0 = not active	1
139	U	3 / 4	Manual Bypass Switch Closed	0 = open 1 = closed	1
140	U	3 / 4	OUTPUT_VOLT0	Outputvoltage Phase 1	1
141	U	3 / 4	OUTPUT_VOLT1	Outputvoltage Phase 2	1
142	U	3 / 4	OUTPUT_VOLT2	Outputvoltage Phase 3	1
143	U	3 / 4	OutputCurrent Phase A * 10	Output Current Phase 1 in Ampere divided by 10	1
144	U	3 / 4	OutputCurrent Phase B * 10	Output Current Phase 1 in Ampere divided by 10	1
145	U	3 / 4	OutputCurrent Phase C * 10	Output Current Phase 1 in Ampere divided by 10	1
146	U	3 / 4	xid3017 Bits 0-15	Statusbit, for details please contact NEWAVE	1
147	U	3 / 4	xid3017 Bits 16-31	Statusbit, for details please contact ABB/NEWAVE	1
148	U	3 / 4	xid645 Bits 0-15	Alarmbit, for details please contact ABB/NEWAVE	1
149	U	3 / 4	xid645 Bits 16-31	Alarmbit, for details please contact ABB/NEWAVE	1

Address	Type	Function	Name	Description	Length
150	U	3 / 4	xid645 Bits 32-47	Alarmbit, for details please contact ABB/NEWAVE	1
151	U	3 / 4	xid645 Bits 48-63	Alarmbit, for details please contact ABB/NEWAVE	1
152	U	3 / 4	Sensormanager/SMTCOM sensor 1	Analog value	1
153	U	3 / 4	Sensormanager/SMTHCOM sensor 2	Analog value	1
154	U	3 / 4	Sensormanager sensor 3	Analog value	1
155	U	3 / 4	Sensormanager sensor 4	Analog value	1
156	U	3 / 4	Sensormanager sensor 5	Analog value	1
157	U	3 / 4	Sensormanager sensor 6	Analog value	1
158	U	3 / 4	Sensormanager sensor 7	Analog value	1
159	U	3 / 4	Sensormanager sensor 8	Analog value	1
160	U	3 / 4	TrueOutputPower Phase A in KW	True Output Power Current Phase 1 in Kilowatt	1
161	U	3 / 4	TrueOutputPower Phase A in KW	True Output Power Current Phase 1 in Kilowatt	1
162	U	3 / 4	TrueOutputPower Phase A in KW	True Output Power Current Phase 1 in Kilowatt	1
163	U	3 / 4	AUX Port 1	1 = active (high), 0 = not active (low)	1
164	U	3 / 4	AUX Port 2	1 = active (high), 0 = not active (low)	1
165	U	3 / 4	AUX Port 3	1 = active (high), 0 = not active (low)	1
166	U	3 / 4	AUX Port 4	1 = active (high), 0 = not active (low)	1
167	U	3 / 4	BATTERYCURRENT	Battery Current in Ampere	1
168	U	3 / 4	OUTFREQ0	Output Frequency Phase 1 in Hz	1
169	U	3 / 4	UPSIDMASK&0xFFFF	for details please contact NEWAVE	1
170	U	3 / 4	(UPSIDMASK&0xFFFF0000)>>16	for details please contact NEWAVE	1
171	U	3 / 4	AUXINPFREQ0	Auxiliary Input Frequency Phase 1	1
172	U	3 / 4	AUXINPFREQ1	Auxiliary Input Frequency Phase 2	1
173	U	3 / 4	AUXINPFREQ2	Auxiliary Input Frequency Phase 3	1
174	U	3 / 4	AUXINPVOLT0	Auxiliary Input Voltage Phase 1	1
175	U	3 / 4	AUXINPVOLT1	Auxiliary Input Voltage Phase 2	1
176	U	3 / 4	AUXINPVOLT2	Auxiliary Input Voltage Phase 3	1
177	U	3 / 4	BP_FREQ0	Bypass Frequency	1
178	U	3 / 4	BP_VOLT0	Bypass Voltage Phase 1	1
179	U	3 / 4	BP_VOLT1	Bypass Voltage Phase 1	1
180	U	3 / 4	BP_VOLT2	Bypass Voltage Phase 3	1
181	U	3 / 4	(RAWSTATEB&0x8)!=0x8	Statusbit, for details please contact ABB/NEWAVE	1
182	U	3 / 4	SolaBCOND	Battery Condition: 0=good, 1=weak, 2=replace	1

Address	Type	Function	Name	Description	Length
183	U	3 / 4	CONCE_IDENT	String Identifying the UPS	1
Note for systems with more then one installed UPS module:					
Starting from register 30100, all values coming from the single module #1 are stored sequentially, according to the sequence adopted for registers 100...166. The values from Module #2 are stored starting at register address 30200 and so forth, until the last module #30 ranging from 33000 ... 33066.					
UPS MODULE 1: 30100 - 30166					
30100	U	3 / 4	OUTPOWER0	Outpower Phase 1 %	1
30101	U	3 / 4	OUTPOWER1	Outpower Phase 2 %	1
30102	U	3 / 4	OUTPOWER2	Outpower Phase 3 %	1
30103	U	3 / 4	BATTCAP	Battery Capacity %	1
30104	S	3 / 4	INVOLT0	Input Voltage Phase 1 V	1
30105	S	3 / 4	INVOLT1	Input Voltage Phase 2 V	1
30106	S	3 / 4	INVOLT2	Input Voltage Phase 3 V	1
30107	S	3 / 4	TEMPDEG	Temperature C°	1
30108	S	3 / 4	AUTONOMTIME	Autonomy Time minutes	1
30109	U	3 / 4	STATUS (e. g. UPS normal = "4", Powerfail = "12", Battery test running = "68", Bypass = "5")	UPS Status (ASCII HEX) Please note UPSMAN status bytes table below	1
30110	S	3 / 4	BATTVOLT	Battery Voltage V	1
30111	U	3 / 4	INFREQ0	Input Frequency Hz Phase 1	1
30112	U	3 / 4	INFREQ1	Input Frequency Hz Phase 2	1
30113	U	3 / 4	INFREQ2	Input Frequency Hz Phase 3	1
30114	U	3 / 4	CNT_PF	Powerfail Counter	1
30115	U	3 / 4	Alarm Battery Bad	1 = active; 0 = not active	1
30116	U	3 / 4	Alarm: On Battery	1 = active; 0 = not active	1
30117	U	3 / 4	Alarm: Battery Low	1 = active; 0 = not active	1
30118	U	3 / 4	Alarm: Battery Depleted	1 = active; 0 = not active	1
30119	U	3 / 4	Alarm: Over temperature	1 = active; 0 = not active	1
30120	U	3 / 4	Alarm: Input Bad	1 = active; 0 = not active	1
30121	U	3 / 4	Alarm: Output Bad	1 = active; 0 = not active	1
30122	U	3 / 4	Alarm: Output Overload	1 = active; 0 = not active	1
30123	U	3 / 4	Alarm: On Bypass	1 = active; 0 = not active	1
30124	U	3 / 4	Alarm: Bypass Bad	1 = active; 0 = not active	1
30125	U	3 / 4	Alarm: Output Off as requested.	1 = active; 0 = not active	1
[...] continue until [...]					
30160	U	3 / 4	TrueOutputPower Phase A in KW	True Output Power Current Phase 1 in Kilowatt	1

Address	Type	Function	Name	Description	Length
30161	U	3 / 4	TrueOutputPower Phase A in KW	True Output Power Current Phase 1 in Kilowatt	1
30162	U	3 / 4	TrueOutputPower Phase A in KW	True Output Power Current Phase 1 in Kilowatt	1
30163	U	3 / 4	AUX Port 1	1 = active (high), 0 = not active (low)	1
30164	U	3 / 4	AUX Port 2	1 = active (high), 0 = not active (low)	1
30165	U	3 / 4	AUX Port 3	1 = active (high), 0 = not active (low)	1
30166	U	3 / 4	AUX Port 4	1 = active (high), 0 = not active (low)	1
UPS MODULE 2: 30200 - 30266					
30200	U	3 / 4	OUTPOWER0	Outpower Phase 1 %	1
30201	U	3 / 4	OUTPOWER1	Outpower Phase 2 %	1
30202	U	3 / 4	OUTPOWER2	Outpower Phase 3 %	1
30203	U	3 / 4	BATTCAP	Battery Capacity %	1
30204	S	3 / 4	INVOLT0	Input Voltage Phase 1 V	1
30205	S	3 / 4	INVOLT1	Input Voltage Phase 2 V	1
30206	S	3 / 4	INVOLT2	Input Voltage Phase 3 V	1
30207	S	3 / 4	TEMPDEG	Temperature C°	1
30208	S	3 / 4	AUTONOMTIME	Autonomy Time minutes	1
30209	U	3 / 4	STATUS (e. g. UPS normal = "4", Powerfail = "12", Battery test running = "68", Bypass = "5")	UPS Status (ASCII HEX) Please note UPSMAN status bytes table below	1
30210	S	3 / 4	BATTVOLT	Battery Voltage V	1
30211	U	3 / 4	INFREQ0	Input Frequency Hz Phase 1	1
30212	U	3 / 4	INFREQ1	Input Frequency Hz Phase 2	1
30213	U	3 / 4	INFREQ2	Input Frequency Hz Phase 3	1
30214	U	3 / 4	CNT_PF	Powerfail Counter	1
30215	U	3 / 4	Alarm Battery Bad	1 = active; 0 = not active	1
30216	U	3 / 4	Alarm: On Battery	1 = active; 0 = not active	1
30217	U	3 / 4	Alarm: Battery Low	1 = active; 0 = not active	1
30218	U	3 / 4	Alarm: Battery Depleted	1 = active; 0 = not active	1
30219	U	3 / 4	Alarm: Over temperature	1 = active; 0 = not active	1
30220	U	3 / 4	Alarm: Input Bad	1 = active; 0 = not active	1
30221	U	3 / 4	Alarm: Output Bad	1 = active; 0 = not active	1
30222	U	3 / 4	Alarm: Output Overload	1 = active; 0 = not active	1
30223	U	3 / 4	Alarm: On Bypass	1 = active; 0 = not active	1
30224	U	3 / 4	Alarm: Bypass Bad	1 = active; 0 = not active	1
30225	U	3 / 4	Alarm: Output Off as requested.	1 = active; 0 = not active	1

Address	Type	Function	Name	Description	Length
[...] continue until [...]					
30261	U	3 / 4	TrueOutputPower Phase A in KW	True Output Power Current Phase 1 in Kilowatt	1
30262	U	3 / 4	TrueOutputPower Phase A in KW	True Output Power Current Phase 1 in Kilowatt	1
30263	U	3 / 4	AUX Port 1	1 = active (high), 0 = not active (low)	1
30264	U	3 / 4	AUX Port 2	1 = active (high), 0 = not active (low)	1
30265	U	3 / 4	AUX Port 3	1 = active (high), 0 = not active (low)	1
30266	U	3 / 4	AUX Port 4	1 = active (high), 0 = not active (low)	1
UPS Module 3: 30300 - 30366					
30300	U	3 / 4	OUTPOWER0	Outpower Phase 1 %	1
30301	U	3 / 4	OUTPOWER1	Outpower Phase 2 %	1
30302	U	3 / 4	OUTPOWER2	Outpower Phase 3 %	1
30303	U	3 / 4	BATTCAP	Battery Capacity %	1
30304	S	3 / 4	INVOLT0	Input Voltage Phase 1 V	1
30305	S	3 / 4	INVOLT1	Input Voltage Phase 2 V	1
30306	S	3 / 4	INVOLT2	Input Voltage Phase 3 V	1
30307	S	3 / 4	TEMPDEG	Temperature C°	1
30308	S	3 / 4	AUTONOMTIME	Autonomy Time minutes	1
30309	U	3 / 4	STATUS (e. g. UPS normal = "4", Powerfail = "12", Battery test running = "68", Bypass = "5")	UPS Status (ASCII HEX) Please note UPSMAN status bytes table below	1
30310	S	3 / 4	BATTVOLT	Battery Voltage V	1
30311	U	3 / 4	INFREQ0	Input Frequency Hz Phase 1	1
30312	U	3 / 4	INFREQ1	Input Frequency Hz Phase 2	1
30213	U	3 / 4	INFREQ2	Input Frequency Hz Phase 3	1
30314	U	3 / 4	CNT_PF	Powerfail Counter	1
30315	U	3 / 4	Alarm Battery Bad	1 = active; 0 = not active	1
[...] continue until [...]					
30361	U	3 / 4	TrueOutputPower Phase A in KW	True Output Power Current Phase 1 in Kilowatt	1
30362	U	3 / 4	TrueOutputPower Phase A in KW	True Output Power Current Phase 1 in Kilowatt	1
30363	U	3 / 4	AUX Port 1	1 = active (high), 0 = not active (low)	1
30364	U	3 / 4	AUX Port 2	1 = active (high), 0 = not active (low)	1
30365	U	3 / 4	AUX Port 3	1 = active (high), 0 = not active (low)	1
30366	U	3 / 4	AUX Port 4	1 = active (high), 0 = not active (low)	1
UPS Module 4: 30400 - 30466					

Address	Type	Function	Name	Description	Length
30400	U	3 / 4	OUTPOWER0	Outpower Phase 1 %	1
30401	U	3 / 4	OUTPOWER1	Outpower Phase 2 %	1
30402	U	3 / 4	OUTPOWER2	Outpower Phase 3 %	1
30403	U	3 / 4	BATTCAP	Battery Capacity %	1
30404	S	3 / 4	INVOLT0	Input Voltage Phase 1 V	1
30405	S	3 / 4	INVOLT1	Input Voltage Phase 2 V	1
30406	S	3 / 4	INVOLT2	Input Voltage Phase 3 V	1
30407	S	3 / 4	TEMPDEG	Temperature C°	1
30408	S	3 / 4	AUTONOMTIME	Autonomy Time minutes	1
30409	U	3 / 4	STATUS (e. g. UPS normal = "4", Powerfail = "12", Battery test running = "68", Bypass = "5")	UPS Status (ASCII HEX) Please note UPSMAN status bytes table below	1
30410	S	3 / 4	BATTVOLT	Battery Voltage V	1
[...] continue until [...]					
30460	U	3 / 4	TrueOutputPower Phase A in KW	True Output Power Current Phase 1 in Kilowatt	1
30461	U	3 / 4	TrueOutputPower Phase A in KW	True Output Power Current Phase 1 in Kilowatt	1
30462	U	3 / 4	TrueOutputPower Phase A in KW	True Output Power Current Phase 1 in Kilowatt	1
30463	U	3 / 4	AUX Port 1	1 = active (high), 0 = not active (low)	1
30464	U	3 / 4	AUX Port 2	1 = active (high), 0 = not active (low)	1
30465	U	3 / 4	AUX Port 3	1 = active (high), 0 = not active (low)	1
30466	U	3 / 4	AUX Port 4	1 = active (high), 0 = not active (low)	1
UPS Module 5: 30500 - 30566					
30500	U	3 / 4	OUTPOWER0	Outpower Phase 1 %	1
30501	U	3 / 4	OUTPOWER1	Outpower Phase 2 %	1
30502	U	3 / 4	OUTPOWER2	Outpower Phase 3 %	1
30503	U	3 / 4	BATTCAP	Battery Capacity %	1
30504	S	3 / 4	INVOLT0	Input Voltage Phase 1 V	1
30505	S	3 / 4	INVOLT1	Input Voltage Phase 2 V	1
[...] continue until [...]					
30563	U	3 / 4	AUX Port 1	1 = active (high), 0 = not active (low)	1
30564	U	3 / 4	AUX Port 2	1 = active (high), 0 = not active (low)	1
30565	U	3 / 4	AUX Port 3	1 = active (high), 0 = not active (low)	1
30566	U	3 / 4	AUX Port 4	1 = active (high), 0 = not active (low)	1
The address range of the UPS Modules 6 – 30 follows as seen above:					
UPS Module 6: 30600 - 30666					

Address	Type	Function	Name	Description	Length
UPS Module 7: 30700 – 30766					
UPS Module 8: 30800 – 30866					
UPS Module 9: 30900 – 30966					
UPS Module 10: 31000 - 31066					
UPS Module 11: 31100 – 31166					
UPS Module 12: 31200 – 31266					
UPS Module 13: 31300 – 31366					
UPS Module 14: 31400 – 31466					
UPS Module 15: 31500 – 31566					
UPS Module 16: 31600 – 31666					
UPS Module 17: 31700 – 31766					
UPS Module 18: 31800 – 31866					
UPS Module 19: 31900 – 31966					
UPS Module 20: 32000 – 32066					
UPS Module 21: 32100 – 32166					
UPS Module 22: 32200 – 32266					
UPS Module 23: 32300 – 32366					
UPS Module 24: 32400 – 32466					
UPS Module 25: 32500 – 32566					
UPS Module 26: 32600 – 32666					
UPS Module 27:32700 – 32766					
UPS Module 28: 32800 – 32866					
UPS Module 29: 32900 – 32966					
UPS Module 30: 33000 – 33066					

Section OEM: MASTERGUARD

Address	Type	Function	Name	Description	Length
97	U	3 / 4	OUTPUT_VOLT0	Output Voltage Phase 1 in V	1
98	U	3 / 4	OUTPUT_VOLT1	Output Voltage Phase 2 in V	1
99	U	3 / 4	OUTPUT_VOLT2	Output Voltage Phase 3 in V	1
100	U	3 / 4	OUTPOWER0	Outpower Phase 1 %	1
101	U	3 / 4	OUTPOWER1	Outpower Phase 2 %	1
102	U	3 / 4	OUTPOWER2	Outpower Phase 3 %	1
103	U	3 / 4	BATTCAP	Battery Capacity %	1
104	S	3 / 4	INVOLT0	Input Voltage Phase 1 V	1

105	S	3 / 4	INVOLT1	Input Voltage Phase 2 V	1
106	S	3 / 4	INVOLT2	Input Voltage Phase 3 V	1
107	S	3 / 4	TEMPDEG	Temperature C°	1
108	S	3 / 4	AUTONOMTIME	Autonomy Time minutes	1
109	U	3 / 4	STATUS (e. g. UPS normal = "4", Powerfail = "12", Battery test running = "68", Bypass = "5")	UPS Status (ASCII HEX) Please note UPSMAN status bytes table below	1
110	S	3 / 4	BATTVOLT	Battery Voltage V	1
111	U	3 / 4	INFREQ0	Input Frequency Hz Phase 1	1
112	U	3 / 4	INFREQ1	Input Frequency Hz Phase 2	1
113	U	3 / 4	INFREQ2	Input Frequency Hz Phase 3	1
114	U	3 / 4	CNT_PF	Powerfail Counter	1
115	U	3 / 4	Alarm Battery Bad	1 = active; 0 = not active	1
116	U	3 / 4	Alarm: On Battery	1 = active; 0 = not active	1
117	U	3 / 4	Alarm: Battery Low	1 = active; 0 = not active	1
118	U	3 / 4	Alarm: Battery Depleted	1 = active; 0 = not active	1
119	U	3 / 4	Alarm: Over temperature	1 = active; 0 = not active	1
120	U	3 / 4	Alarm: Input Bad	1 = active; 0 = not active	1
121	U	3 / 4	Alarm: Output Bad	1 = active; 0 = not active	1
122	U	3 / 4	Alarm: Output Overload	1 = active; 0 = not active	1
123	U	3 / 4	Alarm: On Bypass	1 = active; 0 = not active	1
124	U	3 / 4	Alarm: Bypass Bad	1 = active; 0 = not active	1
125	U	3 / 4	Alarm: Output Off as requested.	1 = active; 0 = not active	1
126	U	3 / 4	Alarm: UPS Off as requested.	1 = active; 0 = not active	1
127	U	3 / 4	Alarm: Charger Failed	1 = active; 0 = not active	1
128	U	3 / 4	Alarm: UPS Output Off	1 = active; 0 = not active	1
129	U	3 / 4	Alarm: UPS System Off	1 = active; 0 = not active	1
130	U	3 / 4	Alarm: Fan Failure	1 = active; 0 = not active	1
131	U	3 / 4	Alarm: fuse failure	1 = active; 0 = not active	1
132	U	3 / 4	Alarm: general fault	1 = active; 0 = not active	1
133	U	3 / 4	Alarm: diagnose test failed	1 = active; 0 = not active	1
134	U	3 / 4	Alarm: communication lost	1 = active; 0 = not active	1
135	U	3 / 4	Alarm: awaiting power	1 = active; 0 = not active	1
136	U	3 / 4	Alarm: shutdown pending	1 = active; 0 = not active	1
137	U	3 / 4	Alarm: shutdown imminent	1 = active; 0 = not active	1
138	U	3 / 4	Alarm: test in progress	1 = active; 0 = not active	1
139	U	3 / 4	PXWARN		2

141	U	3 / 4	FAULT CODE 1	1
142	U	3 / 4	FAULT CODE 2	1
143	U	3 / 4	FAULT CODE 3	1
144	U	3 / 4	FAULT CODE 4	1
145	U	3 / 4	BADBATTBLOCK 1	1
146	U	3 / 4	BADBATTBLOCK 1	1
147	U	3 / 4	BADBATTBLOCK 1	1
148	U	3 / 4	BADBATTBLOCK 1	1
149	U	3 / 4	BADBATTBLOCK 1	1
150	U	3 / 4	BADBATTBLOCK 1	1

Section: OEM: Centiel UPS

Address	Type	Function	Name	Description	Length
97	U	3 / 4	OUTPUT_VOLT0		1
98	U	3 / 4	OUTPUT_VOLT1		1
99	U	3 / 4	OUTPUT_VOLT2		1
100	U	3 / 4	OUTPOWER0		1
101	U	3 / 4	OUTPOWER1		1
102	U	3 / 4	OUTPOWER2		1
103	U	3 / 4	BATTCAP		1
104	U	3 / 4	INVOLT0		1
105	U	3 / 4	INVOLT1		1
106	U	3 / 4	INVOLT2		1
107	U	3 / 4	TEMPDEG		1
108	U	3 / 4	AUTONOMTIME		1
109	U	3 / 4	STATUS		1
110	U	3 / 4	BATTVOLT		1
111	U	3 / 4	INFREQ0		1
112	U	3 / 4	INFREQ1		1
113	U	3 / 4	INFREQ2		1
114	U	3 / 4	CNT_PF		1
115	U	3 / 4	(SNMPALARMS&0x1)		1
116	U	3 / 4	(SNMPALARMS&0x2)>>1		1
117	U	3 / 4	(SNMPALARMS&0x4)>>2		1
118	U	3 / 4	(SNMPALARMS&0x8)>>3		1
119	U	3 / 4	(SNMPALARMS&0x10)>>4		1
120	U	3 / 4	(SNMPALARMS&0x20)>>5		1
121	U	3 / 4	(SNMPALARMS&0x40)>>6		1
122	U	3 / 4	(SNMPALARMS&0x80)>>7		1
123	U	3 / 4	(SNMPALARMS&0x100)>>8		1
124	U	3 / 4	(SNMPALARMS&0x200)>>9		1
125	U	3 / 4	(SNMPALARMS&0x400)>>10		1
126	U	3 / 4	(SNMPALARMS&0x800)>>11		1
127	U	3 / 4	(SNMPALARMS&0x1000)>>12		1
128	U	3 / 4	(SNMPALARMS&0x2000)>>13		1
129	U	3 / 4	(SNMPALARMS&0x4000)>>14		1
130	U	3 / 4	(SNMPALARMS&0x8000)>>15		1
131	U	3 / 4	(SNMPALARMS&0x10000)>>16		1

132	U	3 / 4	(SNMPALARMS&0x20000)>>17	1
133	U	3 / 4	(SNMPALARMS&0x40000)>>18	1
134	U	3 / 4	(SNMPALARMS&0x80000)>>19	1
135	U	3 / 4	(SNMPALARMS&0x100000)>>20	1
136	U	3 / 4	(SNMPALARMS&0x200000)>>21	1
137	U	3 / 4	(SNMPALARMS&0x400000)>>22	1
138	U	3 / 4	(SNMPALARMS&0x800000)>>23	1
139	U	3 / 4	AUX1STATE	1
140	U	3 / 4	AUX2STATE	1
141	U	3 / 4	AUX3STATE	1
142	U	3 / 4	AUX4STATE	1
143	U	3 / 4	TEMP1	1
144	U	3 / 4	TEMP2	1
145	U	3 / 4	TEMP3	1
146	U	3 / 4	TEMP4	1
147	U	3 / 4	TEMP5	1
148	U	3 / 4	TEMP6	1
149	U	3 / 4	TEMP7	1
150	U	3 / 4	TEMP8	1
151	U	3 / 4	(MODULEMASK&0xFFFF)	1
152	U	3 / 4	(MODULEMASK&0xFFFF0000)>>16	1
153	U	3 / 4	(RAWSTATEB&0xFFFF)	1
154	U	3 / 4	(RAWSTATEB&0xFFFF0000)>>16	1
155	U	3 / 4	(RAWSTATEA&0xFFFF)	1
156	U	3 / 4	(RAWSTATEA&0xFFFF0000)>>16	1
157	U	3 / 4	(RAWSTATED&0xFFFF)	1
158	U	3 / 4	(RAWSTATED&0xFFFF0000)>>16	1
159	U	3 / 4	EX_OUT_WATT0	1
160	U	3 / 4	EX_OUT_WATT1	1
161	U	3 / 4	EX_OUT_WATT2	1
162	U	3 / 4	CONCE_IDENT	1
163	U	3 / 4	EX_BY_P_VOLT0	1
164	U	3 / 4	EX_BY_P_VOLT1	1
165	U	3 / 4	EX_BY_P_VOLT2	1
166	U	3 / 4	EX_BY_P_FREQ0	1
167	U	3 / 4	EX_BY_P_FREQ1	1
168	U	3 / 4	EX_BY_P_FREQ2	1
169	U	3 / 4	EX_OUT_CURR0	1

170	U	3 / 4	EX_OUT_CURR1	1
171	U	3 / 4	EX_OUT_CURR2	1
172	U	3 / 4	OUTFREQ0	1
173	U	3 / 4	OUTFREQ1	1
174	U	3 / 4	OUTFREQ2	1
175	U	3 / 4	EX_BATT_CURRPOS	1
176	U	3 / 4	EX_BATT_CURRNEG	1
194	U	3 / 4	CONCE_VERSION	1
224	U	3 / 4	Output_KHW	1
225	U	3 / 4	INCURR0	1
226	U	3 / 4	INCURR1	1
227	U	3 / 4	INCURR 2	1
228	U	3 / 4	EX_OUT_VA0	1
229	U	3 / 4	EX_OUT_VA1	1
230	U	3 / 4	EX_OUT_VA2	1
231	U	3 / 4	EX_OUT_WATT0	1
232	U	3 / 4	EX_OUT_WATT1	1
233	U	3 / 4	EX_OUT_WATT2	1

Section OEM: RITTAL PMC Extension

Address	Type	Function	Name	Description	Length
Digital Input Status(DI)					
0	bit	2	Bypass working	Status 0: Normal, Status 1: Alert	1
1	bit	2	Bypass Interruption	Status 0: Normal, Status 1: Alert	1
2	bit	2	Rectifier Failure	Status 0: Normal, Status 1: Alert	1
3	bit	2	Inverter Failure	Status 0: Normal, Status 1: Alert	1
4	bit	2	Over Temperature	Status 0: Normal, Status 1: Alert	1
5	bit	2	Over Load	Status 0: Normal, Status 1: Alert	1
6	bit	2	0	Status 0: Normal, Status 1: Alert	1
7	bit	2	Battery Voltage too Low	Status 0: Normal, Status 1: Alert	1
8	bit	2	Fuse broken	Status 0: Normal, Status 1: Alert	1
9	bit	2	Battery discharging	Status 0: Normal, Status 1: Alert	1
10	bit	2	0	Status 0: Floating charge, Status 1: Instant charging	1
11~30	bit	2	For future expansion		1
After 31	bit	2	Venders own definition		1
Analog Measurement point (AI)					

00	word	4	U in R phase input voltage	0.1 Volt
01	word	4	U in S phase input voltage	0.1 Volt
02	word	4	U in T phase input voltage	0.1 Volt
03	word	4	I in R phase input current	0.1A
04	word	4	I in S phase input current	0.1A
05	word	4	I in T phase input current	0.1A
06	word	4	F input frequency	0.1Hz
07	word	4	U out R phase output voltage	0.1 Volt
08	word	4	U out S phase output voltage	0.1 Volt
09	word	4	U out T phase output voltage	0.1 Volt
10	word	4	I out R phase output current	0.1A
11	word	4	I out S phase output current	0.1A
12	word	4	I out T phase output current	0.1A
13	word	4	P out output power	0.1kVA
14	word	4	P out output power	0.1kW
15	word	4	PF output power factor	0.01Cos
16	word	4	U Bypass, R phase voltage	0.1 Volt
17	word	4	U Bypass, S phase voltage	0.1 Volt
18	word	4	U Bypass, T phase voltage	0.1 Volt
19	word	4	F out output frequency	0.1Hz
20	word	4	U Bat battery voltage	0.1 Volt
21	word	4	I charch Bat battery charging/discharging	0.1A
22	word	4	Temp 1 battery temperature	0.1degC
23	word	4	Temp 2 battery temperature	0.1degC
24	word	4	Temp 3 battery temperature	0.1degC
25	word	4	Temp 4 battery temperature	0.1degC
26	word	4	Temp 5 UPS shelf temperature	0.1degC
Digital output (DO) (Function 1 to read data; 5 to control the function)				
0	bit	1 / 5	UPS Turn On	
1	bit	1 / 5	UPS Shut down	
2	bit	1 / 5	Alarm Reset	
3	bit	1 / 5	Battery Instant Charging	
4	bit	1 / 5	Battery Floating Charging	
5~10	bit		For future expansion	
After			Vender self-definition	

Address	Type	Function	Name	Description	Length
100	U	3 / 4	OUTPOWER0	True Output Power Current Phase 1 in Kilowatt	1
101	U	3 / 4	OUTPOWER1	True Output Power Current Phase 2 in Kilowatt	1
102	U	3 / 4	OUTPOWER2	True Output Power Current Phase 3 in Kilowatt	1
103	U	3 / 4	BATTCAP	Battery Capacity in %	1
104	U	3 / 4	INVOLT0	Input Voltage Phase 1	1
105	U	3 / 4	INVOLT1	Input Voltage Phase 2	1
106	U	3 / 4	INVOLT2	Input Voltage Phase 3	1
107	U	3 / 4	TEMPDEG	Temperature in Degree C°	1
108	U	3 / 4	AUTONOMTIME	Autonomy Time in Minutes	1
109	U	3 / 4	STATUS	UPS Status (ASCII HEX) Please note UPSMAN status bytes table below	1
110	U	3 / 4	BATTVOLT	Battery Voltage	1
111	U	3 / 4	INFREQ0	Input Frequency Phase 1 in Hz	1
112	U	3 / 4	INFREQ1	Input Frequency Phase 2 in Hz	1
113	U	3 / 4	INFREQ2	Input Frequency Phase 3 in Hz	1
114	U	3 / 4	CNT_PF	Powerfail Counter	1
115	U	3 / 4	SNMP Alarm	Alarmbit, for details please contact NEWAVE	1
116	U	3 / 4	SNMP Alarm	Alarmbit, for details please contact NEWAVE	1
117	U	3 / 4	SNMP Alarm	Alarmbit, for details please contact NEWAVE	1
118	U	3 / 4	SNMP Alarm	Alarmbit, for details please contact NEWAVE	1
119	U	3 / 4	SNMP Alarm	Alarmbit, for details please contact NEWAVE	1
120	U	3 / 4	SNMP Alarm	Alarmbit, for details please contact NEWAVE	1
121	U	3 / 4	SNMP Alarm	Alarmbit, for details please contact NEWAVE	1
122	U	3 / 4	SNMP Alarm	Alarmbit, for details please contact NEWAVE	1
123	U	3 / 4	SNMP Alarm	Alarmbit, for details please contact NEWAVE	1
124	U	3 / 4	SNMP Alarm	Alarmbit, for details please contact NEWAVE	1
125	U	3 / 4	SNMP Alarm	Alarmbit, for details please contact NEWAVE	1
126	U	3 / 4	SNMP Alarm	Alarmbit, for details please contact NEWAVE	1
127	U	3 / 4	SNMP Alarm	Alarmbit, for details please contact NEWAVE	1
128	U	3 / 4	SNMP Alarm	Alarmbit, for details please contact NEWAVE	1
129	U	3 / 4	SNMP Alarm	Alarmbit, for details please contact NEWAVE	1
130	U	3 / 4	SNMP Alarm	Alarmbit, for details please contact NEWAVE	1
131	U	3 / 4	SNMP Alarm	Alarmbit, for details please contact NEWAVE	1
132	U	3 / 4	SNMP Alarm	Alarmbit, for details please contact NEWAVE	1

Address	Type	Function	Name	Description	Length
133	U	3 / 4	SNMP Alarm	Alarmbit, for details please contact NEWAVE	1
134	U	3 / 4	SNMP Alarm	Alarmbit, for details please contact NEWAVE	1
135	U	3 / 4	SNMP Alarm	Alarmbit, for details please contact NEWAVE	1
136	U	3 / 4	SNMP Alarm	Alarmbit, for details please contact NEWAVE	1
137	U	3 / 4	SNMP Alarm	Alarmbit, for details please contact NEWAVE	1
138	U	3 / 4	SNMP Alarm	Alarmbit, for details please contact NEWAVE	1
139	U	3 / 4	Status Bit	Statusbit, for details please contact NEWAVE	1
140	U	3 / 4	OUTPUT_VOLT0	Output Voltage Phase 1	1
141	U	3 / 4	OUTPUT_VOLT1	Output Voltage Phase 2	1
142	U	3 / 4	OUTPUT_VOLT2	Output Voltage Phase 3	1
143	U	3 / 4	OUTPUT_CURR0	Output Current Phase 1 in KW	1
144	U	3 / 4	OUTPUT_CURR1	Output Current Phase 2 in KW	1
145	U	3 / 4	OUTPUT_CURR2	Output Current Phase 3 in KW	1
146	U	3 / 4	Status Bit	Statusbit, for details please contact NEWAVE	1
147	U	3 / 4	Status Bit	Statusbit, for details please contact NEWAVE	1
148	U	3 / 4	Status Bit	Statusbit, for details please contact NEWAVE	1
149	U	3 / 4	Status Bit	Statusbit, for details please contact NEWAVE	1
150	U	3 / 4	Status Bit	Statusbit, for details please contact NEWAVE	1
151	U	3 / 4	Status Bit	Statusbit, for details please contact NEWAVE	1
152	U	3 / 4	TEMP1	SensorManager/SM_T_H_COM Analog Value	1
153	U	3 / 4	TEMP2	SensorManager/SM_T_H_COM Analog Value	1
154	U	3 / 4	TEMP3	SensorManager Analog Value	1
155	U	3 / 4	TEMP4	SensorManager Analog Value	1
156	U	3 / 4	TEMP5	SensorManager Analog Value	1
157	U	3 / 4	TEMP6	SensorManager Analog Value	1
158	U	3 / 4	TEMP7	SensorManager Analog Value	1
159	U	3 / 4	TEMP8	SensorManager Analog Value	1
160	U	3 / 4	LOADKVA0	Load Phase 1 in KW	1
161	U	3 / 4	LOADKVA1	Load Phase 2 in KW	1
162	U	3 / 4	LOADKVA2	Load Phase 3 in KW	1

Section OEM: Netminder for all LT and MD types

Address	Type	Function	Name	Description	Length
100	U	3/4	INVOLT	Input Voltage	1
101	U	3/4	OUTPUTVOLT	Output Voltage	1

102	U	3/4	BATTVOLT	Battery Voltage	1
103	U	3/4	OUTPUTCURR	Output Current	1
104	U	3/4	LOADPERC	Load (%)	1
105	U	3/4	OUTPUTPOW	Output Power in W	1
106	U	3/4	KVA	KVA	1
107	U	3/4	FREQUENCY	Frequency	1
108	U	3/4	CS141UPSSTAT	CS141 UPS Status	1
109	U	3/4	Alarm: Battery Bad	1 = active; 0 = not active	1
110	U	3/4	Alarm: On Battery	1 = active; 0 = not active	1
111	U	3/4	Alarm: Battery Low	1 = active; 0 = not active	1
112	U	3/4	Alarm: Battery Depleted	1 = active; 0 = not active	1
113	U	3/4	Alarm: Overtemperature	1 = active; 0 = not active	1
114	U	3/4	Alarm: Input Bad	1 = active; 0 = not active	1
115	U	3/4	Alarm: Output Bad	1 = active; 0 = not active	1
116	U	3/4	Alarm: Output Overload	1 = active; 0 = not active	1
117	U	3/4	Alarm: On Bypass	1 = active; 0 = not active	1
118	U	3/4	Alarm: Bypass Bad	1 = active; 0 = not active	1
119	U	3/4	Alarm: Ouput Off As Requested	1 = active; 0 = not active	1
120	U	3/4	Alarm: UPS Off As Requested	1 = active; 0 = not active	1
121	U	3/4	Alarm: Charger Failed	1 = active; 0 = not active	1
122	U	3/4	Alarm: UPS Output Off	1 = active; 0 = not active	1
123	U	3/4	Alarm: UPS System Off	1 = active; 0 = not active	1
124	U	3/4	Alarm: Fan Failure	1 = active; 0 = not active	1
125	U	3/4	Alarm: Fuse Failure	1 = active; 0 = not active	1
126	U	3/4	Alarm: General Fault	1 = active; 0 = not active	1
127	U	3/4	Alarm: Diagnosis Test Failed	1 = active; 0 = not active	1
128	U	3/4	Alarm: Communication Lost	1 = active; 0 = not active	1
129	U	3/4	Alarm: Awaiting Power	1 = active; 0 = not active	1
130	U	3/4	Alarm: Shutdown Pending	1 = active; 0 = not active	1
131	U	3/4	Alarm: Shutdown Imminent	1 = active; 0 = not active	1
132	U	3/4	Alarm: Test In Progress	1 = active ; 0 = not active	1
133	U	3/4	AUX Port 1	1 = active (high) ; 0 = not active (low)	1
134	U	3/4	AUX Port 2	1 = active (high) ; 0 = not active (low)	1
135	U	3/4	AUX Port 3	1 = active (high) ; 0 = not active (low)	1
136	U	3/4	AUX Port 4	1 = active (high) ; 0 = not active (low)	1
137	U	3/4	SensorManager/SMTH_COM, Sensor 1	Analog Value	1
138	U	3/4	SensorManager/SMTH_COM, Sensor 2	Analog Value	1

139	U	3/4	SensorManager/Sensor 3	Analog Value	1
140	U	3/4	SensorManager/Sensor 4	Analog Value	1
141	U	3/4	SensorManager/Sensor 5	Analog Value	1
142	U	3/4	SensorManager/Sensor 6	Analog Value	1
143	U	3/4	SensorManager/Sensor 7	Analog Value	1
144	U	3/4	SensorManager/Sensor 8	Analog Value	1
145	U	3/4	Result of the last Battery Test	Value 3 = Battery Test passed, Value 4 = Battery Test failed	1

Section OEM: Netminder EON

Address	Type	Function	Name	Description	Length
11	U	3 / 4	Manufacturer	Manufacturer	1
27	U	3 / 4	Version	Version	1
43	U	3 / 4	Identification	Identification	1
75	U	3 / 4	MODEL	UPS Model	1
107	U	3 / 4	AUTONOMTIME	Autonomy time in minutes	1
108	U	3 / 4	BATTCAP	Battery capacity in percent	1
109	U	3 / 4	OUTFREQ0	Output Frequency	1
110	U	3 / 4	OUTPUTVOLT0	Output Voltage Phase 1	1
111	U	3 / 4	OUTPUTVOLT1	Output Voltage Phase 2	1
112	U	3 / 4	OUTPUTVOLT1	Output Voltage Phase 3	1
113	U	3 / 4	OUTPOWER0	Outpower Phase 1 in %	1
114	U	3 / 4	OUTPOWER1	Outpower Phase 2 in %	1
115	U	3 / 4	OUTPOWER2	Outpower Phase 3 in %	1
116	U	3 / 4	OUTPOWER0	Outpower Phase 1 in VA	1
117	U	3 / 4	OUTPOWER1	Outpower Phase 2 in VA	1
118	U	3 / 4	OUTPOWER2	Outpower Phase 3 in VA	1
119	U	3 / 4	INPUTFREQ0	Input Frequency Phase 1 in Hz	1
120	U	3 / 4	INPUTFREQ1	Input Frequency Phase 2 in Hz	1
121	U	3 / 4	INPUTFREQ2	Input Frequency Phase 3 in Hz	1
122	U	3 / 4	INPUTVOLT0	Input Voltage Phase 1 in V	1
123	U	3 / 4	INPUTVOLT1	Input Voltage Phase 2 in V	1
124	U	3 / 4	INPUTVOLT2	Input Voltage Phase 3 in V	1
125	U	3 / 4	INPUTCURRE0	Input Current Phase 1 in A	1
126	U	3 / 4	INPUTCURRE1	Input Current Phase 2 in A	1
127	U	3 / 4	INPUTCURRE2	Input Current Phase 3 in A	1
128	U	3 / 4	INPUTPOW0	Input Power Phase 1 in W	1

129	U	3 / 4	INPUTPOW1	Input Power Phase 2 in W	1
130	U	3 / 4	INPUTPOW1	Input Power Phase 3 in W	1
131	U	3 / 4	BATTVOLT	Battery Voltage in V	1
132	U	3 / 4	BATTEMPDEG	Battery Temperature in Degree Celsius	1
133	U	3 / 4	BATTSEC	Seconds on Battery	1
134	U	3 / 4	Battery Condition	Battery Condition	1
135	U	3 / 4	Amount of Input Phases	Amount of Input Phases	1
136	U	3 / 4	Amount of Output Phases	Amount of Output Phases	1
137	U	3 / 4	Results of Battery Test	1:Ok, 2: Active, 3: Canceled, 4: Failed, else: not started yet	1
138	U	3 / 4	Powerfail	Powerfail	1
139	U	3 / 4	System Shutdown	System Shutdown	1
140	U	3 / 4	UPSMAN started	UPSMAN started	1
141	U	3 / 4	UPS Connection lost	UPS connection lost	1
142	U	3 / 4	UPS Battery old	UPS Battery old	1
143	U	3 / 4	Load >80%	Load >80%	1
144	U	3 / 4	Load >90%	Load >90%	1
145	U	3 / 4	Overload	Overload	1
146	U	3 / 4	Overtemperature Condition	Overtemperature Condition	1
147	U	3 / 4	Bypass on	Bypass on	1
148	U	3 / 4	Battery low	Battery low	1
149	U	3 / 4	Batteries are weak	Batteries are weak	1
150	U	3 / 4	General Alarm Condition	General Alarm Condition	1
151	U	3 / 4	Input Bad Condition	Input Bad Condition	1
152	U	3 / 4	Output Bad Condition	Output Bad Condition	1
153	U	3 / 4	Bypass Not Available	Bypass Not Available	1
154	U	3 / 4	Low Battery Shutdown	Low Battery Shutdown	1
155	U	3 / 4	System off	System off	1
156	U	3 / 4	System Shutdown	System Shutdown	1
157	U	3 / 4	Charger Failure	Charger Failure	1
158	U	3 / 4	Manual Restart Required	Manual Restart Required	1
159	U	3 / 4	Output Circuit Breaker Open	Output Circuit Breaker Open	1
160	U	3 / 4	Remote Emergency Power off	Remote Emergency Power off	1
161	U	3 / 4	Shutdown imminent	Shutdown imminent	1

Section OEM: Netminder for all other types

Address	Type	Function	Name	Description	Length
---------	------	----------	------	-------------	--------

100	U	3/4	INVOLT	Input Voltage (I1-n)	1
101	U	3/4	INVOLT	Input Voltage (I2-n)	1
102	U	3/4	INVOLT	Input Voltage (I1-I2)	1
103	U	3/4	OUTPUTVOLT	Output Voltage (I1-n)	1
104	U	3/4	OUTPUTVOLT	Output Voltage (I2-n)	1
105	U	3/4	OUTPUTVOLT	Output Voltage (I1-I2)	1
106	U	3/4	OUTPUTCURR	Output Current (I1-n)	1
107	U	3/4	OUTPUTCURR	Output Current (I2-n)	1
108	U	3/4	OUTPUTWAT	Output Watts (I1-n)	1
109	U	3/4	OUTPUTWAT	Output Watts (I2-n)	1
110	U	3/4	OUTPUTWAT	Output Watts (I1-I2)	1
111	U	3/4	OUTPUTWATTOT	Output watts (total)	1
112	U	3/4	OUTPUTVA	Output VA (I1-n)	1
113	U	3/4	OUTPUTVA	Output VA (I2-n)	1
114	U	3/4	OUTPUTVA	Output VA (I1-I2)	1
115	U	3/4	OUTPUTVATOT	Output VA (total)	1
116	U	3/4	OUTPUTLOAD	Output Load (I1-n)	1
117	U	3/4	OUTPUTLOAD	Output Load (I2-n)	1
118	U	3/4	OUTPUTFREQ	Output Frequency	1
119	U	3/4	BATTVOLT	Battery Voltage	1
120	U	3/4	PERCBATT	Percentage Battery	1
121	U	3/4	DCCHARGECURR	DC Charging Current	1
122	U	3/4	CS141UPSSTAT	CS141 UPS Status	1
123	U	3/4	Alarm: Battery Bad	1 = active; 0 = not active	1
124	U	3/4	Alarm: On Battery	1 = active; 0 = not active	1
125	U	3/4	Alarm: Battery Low	1 = active; 0 = not active	1
126	U	3/4	Alarm: Battery Depleted	1 = active; 0 = not active	1
127	U	3/4	Alarm: Overtemperature	1 = active; 0 = not active	1
128	U	3/4	Alarm: Input Bad	1 = active; 0 = not active	1
129	U	3/4	Alarm: Output Bad	1 = active; 0 = not active	1
130	U	3/4	Alarm: Output Overload	1 = active; 0 = not active	1
131	U	3/4	Alarm: On Bypass	1 = active; 0 = not active	1
132	U	3/4	Alarm: Bypass Bad	1 = active; 0 = not active	1
133	U	3/4	Alarm: Output Off As Requested	1 = active; 0 = not active	1
134	U	3/4	Alarm: UPS Off As Requested	1 = active; 0 = not active	1
135	U	3/4	Alarm: Charger Failed	1 = active; 0 = not active	1
136	U	3/4	Alarm: UPS Output Off	1 = active; 0 = not active	1
137	U	3/4	Alarm: UPS System Off	1 = active; 0 = not active	1

138	U	3/4	Alarm: Fan Failure	1 = active; 0 = not active	1
139	U	3/4	Alarm: Fuse Failure	1 = active; 0 = not active	1
140	U	3/4	Alarm: General Fault	1 = active; 0 = not active	1
141	U	3/4	Alarm: Diagnosis Test Failed	1 = active; 0 = not active	1
142	U	3/4	Alarm: Communication Lost	1 = active; 0 = not active	1
143	U	3/4	Alarm: Awaiting Power	1 = active; 0 = not active	1
144	U	3/4	Alarm: Shutdown Pending	1 = active; 0 = not active	1
145	U	3/4	Alarm: Shutdown Imminent	1 = active; 0 = not active	1
146	U	3/4	Alarm: Test In Progress	1 = active; 0 = not active	1
147	U	3/4	AUX Port 1	1 = active (high) ; 0 = not active (low)	1
148	U	3/4	AUX Port 2	1 = active (high) ; 0 = not active (low)	1
149	U	3/4	AUX Port 3	1 = active (high) ; 0 = not active (low)	1
150	U	3/4	AUX Port 4	1 = active (high) ; 0 = not active (low)	1
151	U	3/4	Sensormngr 1 / SMT_COM,	Analog Value	1
152	U	3/4	Sensormngr 2 /SMTH_COM,	Analog Value	1
153	U	3/4	SensorManager/Sensor 3	Analog Value	1
154	U	3/4	SensorManager/Sensor 4	Analog Value	1
155	U	3/4	SensorManager/Sensor 5	Analog Value	1
156	U	3/4	SensorManager/Sensor 6	Analog Value	1
157	U	3/4	SensorManager/Sensor 7	Analog Value	1
158	U	3/4	SensorManager/Sensor 8	Analog Value	1
159	U	3/4	Result of the last Battery Test	Value 3 = Battery Test pasd Value 4 = Battery Test failed	1

Section OEM : AEG Protect 3. M 2.0

Address	Type	Function	Name	Description	Length
100	U	3/4	(SNMPALARMS&0x6102)==0	Normal Operation	1
101	U	3/4	(SNMPALARMS&0x100)>>8	On Bypass	1
102	U	3/4	(SNMPALARMS&0x2)>>1	On Battery	1
103	U	3/4	(SNMPALARMS&0x4000)>>14	UPS System Off	1
104	U	3/4	(SNMPALARMS&0x20000)>>17	General Fault	1
105	U	3/4	(SNMPALARMS&0x80000)>>19	Communication Lost	1
106	U	3/4	(SNMPALARMS&0x20)>>5	Input Bad	1
107	U	3/4	(SNMPALARMS&0x1000)>>12	Charger Failed	1
108	U	3/4	(SNMPALARMS&0x1)	Battery Bad	1
109	U	3/4	(SNMPALARMS&0x40)>>6	Output Bad	1
110	U	3/4	(SNMPALARMS&0x200)>>9	Bypass Bad	1

111	U	3/4	(SNMPALARMS&0x4)>>2	Low Battery	1
				Depleted Battery	
112	U	3/4	(SNMPALARMS&0x8)>>3		1
113	U	3/4	(SNMPALARMS&0x10)>>4	Temperature Bad	1
114	U	3/4	(SNMPALARMS&0x80)>>7	Output Overload	1
115	U	3/4	(SNMPALARMS&0x8000)>>15	Fan Failure	1
116	U	3/4	(SNMPALARMS&0x2000)>>13	UPS Output Off	1
117	U	3/4	AUX1STATE	1 = active (high) ; 0 = not active (low)	1
118	U	3/4	AUX2STATE	1 = active (high) ; 0 = not active (low)	1
119	U	3/4	AUX3STATE	1 = active (high) ; 0 = not active (low)	1
120	U	3/4	AUX4STATE	1 = active (high) ; 0 = not active (low)	1
121	U	3/4	AMBTEMP		1
122	U	3/4	INFREQ0	Input Frequency Hz Phase 1	1
123	U	3/4	INVOLT0	Input Voltage Phase 1 V	1
124	U	3/4	INVOLT1	Input Voltage Phase 2 V	1
125	U	3/4	INVOLT1	Input Voltage Phase 3 V	1
126	U	3/4	INCURR0	Input Current Phase 1 in Ampere	1
127	U	3/4	INCURR1	Input Current Phase 2 in Ampere	1
128	U	3/4	INCURR2	Input Current Phase 3 in Ampere	1
129	U	3/4	EX_BYP_FREQ		1
130	U	3/4	EX_BYP_VOLT0		1
131	U	3/4	EX_BYP_VOLT1		1
132	U	3/4	EX_BYP_VOLT2		1
133	U	3/4	(EX_BATT_VOLTNEG+EX_BATT_VOLTPOS)*10.0		1
134	U	3/4	(EX_BATT_CURRNEG+EX_BATT_CURRPOS)*5.0		1
135	U	3/4	MIN(ftoi(BATTCAP),ftoi(EX_BATT_CAPNEG))		1
136	U	3/4	AUTONOMTIME	Autonomy Time Minutes	1
137	U	3/4	TEMPDEG	Temperature C°	1
138	U	3/4	OUTFREQ0	Output Frequency Hz	1
139	U	3/4	OUTPUT_VOLT0	Output Voltage Phase 1 V	1
140	U	3/4	OUTPUT_VOLT1	Output Voltage Phase 2 V	1
141	U	3/4	OUTPUT_VOLT2	Output Voltage Phase 3 V	1
142	U	3/4	OUTPOWER0	Outpower Phase 1 %	1
143	U	3/4	OUTPOWER1	Outpower Phase 2 %	1
144	U	3/4	OUTPOWER2	Outpower Phase 3 %	1
145	U	3/4	EX_OUT_CURR0		1

146	U	3/4	EX_OUT_CURR1	1
147	U	3/4	EX_OUT_CURR2	1
148	U	3/4	EX_OUT_WATT0	1
149	U	3/4	EX_OUT_WATT1	1
150	U	3/4	EX_OUT_WATT2	1

Section OEM: AEG Protect 3.31, 5.31, 8.31

Section OEM: AEG Protect 2.33, 3.33, 4.33, 5.33, 8.33, blue

Address	Type	Function	Name	Description	Length
100	U	3/4	(FKTSTATUS&0x4102)==0	Normal Operation	1
101	U	3/4	SNMPALARMS&0x100)>>8	On Bypass	1
102	U	3/4	(SNMPALARMS&0x2)>>1	On Battery	1
103	U	3/4	(SNMPALARMS&0x4000)>>14	UPS System Off	1
104	U	3/4	CNT_PF	Powerfail Counter	1
105	U	3/4	(SNMPALARMS&0x20000)>>17	General Fault	1
106	U	3/4	(SNMPALARMS&0x80000)>>19	Communication Lost	1
107	U	3/4	(SNMPALARMS&0x20)>>5	Input Bad	1
108	U	3/4	(SNMPALARMS&0x1000)>>12	Charger Failed	1
109	U	3/4	(SNMPALARMS&0x1)	Battery Bad	1
110	U	3/4	(SNMPALARMS&0x40)>>6	Output Bad	1
111	U	3/4	(SNMPALARMS&0x200)>>9	Bypass Bad	1
112	U	3/4	(SNMPALARMS&0x4)>>2	Low Battery	1
113	U	3/4	(SNMPALARMS&0x8)>>3	Depleted Battery	1
114	U	3/4	(SNMPALARMS&0x10)>>4	Temperature Bad	1
115	U	3/4	(SNMPALARMS&0x80)>>7	Output Overload	1
116	U	3/4	(SNMPALARMS&0x8000)>>15	Fan Failure	1
117	U	3/4	(SNMPALARMS&0x2000)>>13	UPS Output Off	1
118	U	3/4	AUX1STATE	State AUX Port 1 1 = active (high) ; 0 = not active (low)	1
119	U	3/4	AUX2STATE	State AUX Port 2 1 = active (high) ; 0 = not active (low)	1
120	U	3/4	AUX3STATE	State AUX Port 3 1 = active (high) ; 0 = not active (low)	1
121	U	3/4	AUX4STATE	State AUX Port 4 1 = active (high) ; 0 = not active (low)	1
122	U	3/4	INFREQ0*10.0	Input Frequency Hz Phase 1	1
123	U	3/4	INVOLT0	Input Voltage Phase 1 V	1
124	U	3/4	INVOLT1	Input Voltage Phase 2 V	1

125	U	3/4	INVOLT2	Input Voltage Phase 3 V	1
126	U	3/4	BP_FREQ0*10.0	Output Frequency [Hz]	1
127	U	3/4	BP_VOLT0	Bypass Voltage Phase 1 [V]	1
128	U	3/4	BP_VOLT1	Bypass Voltage Phase 2 [V]	1
129	U	3/4	BP_VOLT2	Bypass Voltage Phase 3 [V]	1
130	U	3/4	BATTVOLT*10.0	Battery Voltage [V] x 10	1
131	U	3/4	SOLABATTC*10.0	Battery Current [A] x 10	1
132	U	3/4	AUTONOMTIME	Autonomy Time in Minutes	1
133	U	3/4	BATTCAP	Battery Capacity	1
134	U	3/4	TEMPDEG*10.0	Temperature [°C] x 10	1
135	U	3/4	OUTFREQ0*10.0	Output Frequency [Hz] x 10	1
136	U	3/4	OUTPUT_VOLT0	Output Voltage Phase 1 [V]	1
137	U	3/4	OUTPOWER0	Outpower Phase 1 [%]	1
138	U	3/4	OUTPUT_CUR0	Output Current Phase 1 [A]	1
139	U	3/4	OUTPUT_POW0	Outpower Phase 1 [W]	1
140	U	3/4	OUTPUT_VOLT1	Output Voltage Phase 2 [V]	1
141	U	3/4	OUTPOWER1	Outpower Phase 2 [%]	1
142	U	3/4	OUTPUT_CUR1	Output Current Phase 2 [A]	1
143	U	3/4	OUTPUT_POW1	Outpower Phase 2 [W]	1
144	U	3/4	OUTPUT_VOLT2	Output Voltage Phase 3 [V]	1
145	U	3/4	OUTPOWER2	Outpower Phase 3 [%]	1
146	U	3/4	OUTPUT_CUR2	Output Current Phase 3 [A]	1
147	U	3/4	OUTPUT_POW2	Outpower Phase 3 [W]	1

Section OEM: POWERTRONIX

Adress	Name	MIZAR ALCOR	QUASAR	SUPERNOVAE
100	Outpower Phase 1 %	x	x	x
101	Outpower Phase 2 %	x	x	x
102	Outpower Phase 3 %	x	x	x
103	Battery Capacity %	x	x	x
104	Input Voltage Phase 1 V	x	x	x
105	Input Voltage Phase 2 V	x	x	x
106	Input Voltage Phase 3 V	x	x	x
107	Temperature °C	not supported	x	x
108	Autonomy Time minutes	x	x	x
109	UPS Status (ASCII Hex)	x	x	x
110	Battery Voltage V	x	x	x

111	Input Frequency Phase 1 Hz	not supported	x	not supported
112	Input Frequency Phase 2 Hz	not supported	x	not supported
113	Input Frequency Phase 3 Hz	not supported	x	not supported
114	Powerfail Counter	x	x	x
115	Alarm: Battery Bad	x	x	x
116	Alarm: On Battery	x	x	x
117	Alarm: Battery Low	not supported	not supported	x
118	Alarm: Battery Depleted	x	not supported	x
119	Alarm: Overtemperature	x	not supported	x
120	Alarm: Input Bad	x	x	x
121	Alarm: Output Bad	not supported	x	not supported
122	Alarm: Output Overload	x	x	x
123	Alarm: On Bypass	x	x	x
124	Alarm: Bypass Bad	x	x	x
125	Alarm: Output Off As Requested	x	x	x
126	Alarm: UPS Off As Requested	x	x	x
127	Alarm: Charger Failed		x	x
128	Alarm: UPS Output Off	x	x	x
129	Alarm: UPS Sytem Off	not supported	x	not supported
130	Alarm: Fan Failure	x	not supported	x
131	Alarm: Fuse Failure	not supported	not supported	not supported
132	Alarm: General Fault	x	x	x
133	Alarm: Diagnose Test Failed	not supported	not supported	not supported
134	Alarm: Communication Lost	x	x	x
135	Alarm: Awaiting Power	not supported	not supported	not supported
136	Alarm: Shutdown Pending	not supported	not supported	not supported
137	Alarm: Shutdown Imminent	not supported	not supported	not supported
138	Alarm: Test In Progress	x	not supported	not supported
139	AUX Port 1	x	x	x
140	AUX Port 2	x	x	x
141	AUX Port 3	x	x	x
142	AUX Port 4	x	x	x

Section OEM: Socomec UPS

Address	Type	Function	Name	Description	Length
97	U	3 / 4	OUTPUT_VOLT0	Output Voltage Phase 1 in V	1
98	U	3 / 4	OUTPUT_VOLT1	Output Voltage Phase 2 in V	1
99	U	3 / 4	OUTPUT_VOLT2	Output Voltage Phase 3 in V	1
100	U	3 / 4	OUTPOWER0	Outpower Phase 1 %	1
101	U	3 / 4	OUTPOWER1	Outpower Phase 2 %	1
102	U	3 / 4	OUTPOWER2	Outpower Phase 3 %	1
103	U	3 / 4	BATTCAP	Battery Capacity %	1
104	S	3 / 4	INVOLT0	Input Voltage Phase 1 V	1
105	S	3 / 4	INVOLT1	Input Voltage Phase 2 V	1
106	S	3 / 4	INVOLT2	Input Voltage Phase 3 V	1
107	S	3 / 4	TEMPDEG	Temperature C°	1
108	S	3 / 4	AUTONOMTIME	Autonomy Time minutes	1
109	U	3 / 4	STATUS	UPS Status (ASCII HEX) Please note UPSMAN status bytes table below (e. g. UPS normal = "4", Powerfail = "12", Battery test running = "68", Bypass = "5")	1
110	S	3 / 4	BATTVOLT	Battery Voltage V	1
111	U	3 / 4	INFREQ0	Input Frequency Hz Phase 1	1
112	U	3 / 4	INFREQ1	Input Frequency Hz Phase 2	1
113	U	3 / 4	INFREQ2	Input Frequency Hz Phase 3	1
114	U	3 / 4	CNT_PF	Powerfail Counter	1
115	U	3 / 4	Alarm Battery Bad	1 = active; 0 = not active	1
116	U	3 / 4	Alarm: On Battery	1 = active; 0 = not active	1
117	U	3 / 4	Alarm: Battery Low	1 = active; 0 = not active	1
118	U	3 / 4	Alarm: Battery Depleted	1 = active; 0 = not active	1
119	U	3 / 4	Alarm: Over temperature	1 = active; 0 = not active	1
120	U	3 / 4	Alarm: Input Bad	1 = active; 0 = not active	1
121	U	3 / 4	Alarm: Output Bad	1 = active; 0 = not active	1
122	U	3 / 4	Alarm: Output Overload	1 = active; 0 = not active	1
123	U	3 / 4	Alarm: On Bypass	1 = active; 0 = not active	1
124	U	3 / 4	Alarm: Bypass Bad	1 = active; 0 = not active	1
125	U	3 / 4	Alarm: Output Off as requested.	1 = active; 0 = not active	1
126	U	3 / 4	Alarm: UPS Off as requested.	1 = active; 0 = not active	1
127	U	3 / 4	Alarm: Charger Failed	1 = active; 0 = not active	1
128	U	3 / 4	Alarm: UPS Output Off	1 = active; 0 = not active	1
129	U	3 / 4	Alarm: UPS System Off	1 = active; 0 = not active	1

Address	Type	Function	Name	Description	Length
130	U	3 / 4	Alarm: Fan Failure	1 = active; 0 = not active	1
131	U	3 / 4	Alarm: fuse failure	1 = active; 0 = not active	1
132	U	3 / 4	Alarm: general fault	1 = active; 0 = not active	1
133	U	3 / 4	Alarm: diagnose test failed	1 = active; 0 = not active	1
134	U	3 / 4	Alarm: communication lost	1 = active; 0 = not active	1
135	U	3 / 4	Alarm: awaiting power	1 = active; 0 = not active	1
136	U	3 / 4	Alarm: shutdown pending	1 = active; 0 = not active	1
137	U	3 / 4	Alarm: shutdown imminent	1 = active; 0 = not active	1
138	U	3 / 4	Alarm: test in progress	1 = active; 0 = not active	1
139	U	3 / 4	AUX Port 1	1 = active (high), 0 = not active (low)	1
140	U	3 / 4	AUX Port 2	1 = active (high), 0 = not active (low)	1
141	U	3 / 4	AUX Port 3	1 = active (high), 0 = not active (low)	1
142	U	3 / 4	AUX Port 4	1 = active (high), 0 = not active (low)	1
143	U	3 / 4	Sensormanager/SMTCOM sensor 1	Analog value	1
144	U	3 / 4	Sensormanager/SMTHCOM sensor 2	Analog value	1
145	U	3 / 4	Sensormanager sensor 3	Analog value	1
146	U	3 / 4	Sensormanager sensor 4	Analog value	1
147	U	3 / 4	Sensormanager sensor 5	Analog value	1
148	U	3 / 4	Sensormanager sensor 6	Analog value	1
149	U	3 / 4	Sensormanager sensor 7	Analog value	1
150	U	3 / 4	Sensormanager sensor 8	Analog value	1
151	U	3 / 4	INCURR0	Input Current Phase 1	1
152	U	3 / 4	INCURR1	Input Current Phase 2	1
153	U	3 / 4	INCURR2	Input Current Phase 3	1
154	U	3 / 4	OUTFREQ0	Output Frequency Phase 1	1
155	U	3 / 4	EX_OUT_CURR0	External Output Current Phase 1	1
156	U	3 / 4	EX_OUT_CURR1	External Output Current Phase 2	1
157	U	3 / 4	EX_OUT_CURR2	External Output Current Phase 3	1

Section MHD Modular / Multimatic Modular / AEG Protect 1. Modular, ENIGMA

Address	Type	Function	Name	Description	Length
100	U	3 / 4	OUTPOWER0	Outpower Phase 1 %	1
101	U	3 / 4	OUTPOWER1	Outpower Phase 2 %	1
102	U	3 / 4	OUTPOWER2	Outpower Phase 3 %	1
103	U	3 / 4	BATTCAP	Battery Capacity %	1
104	S	3 / 4	INVOLT0	Input Voltage Phase 1 V	1
105	S	3 / 4	INVOLT1	Input Voltage Phase 2 V	1

Address	Type	Function	Name	Description	Length
106	S	3 / 4	INVOLT2	Input Voltage Phase 3 V	1
107	S	3 / 4	TEMPDEG	Temperature C°	1
108	S	3 / 4	AUTONOMTIME	Autonomy Time minutes	1
109	U	3 / 4	STATUS (e. g. UPS normal = "4", Powerfail = "12", Battery test running = "68", Bypass = "5")	UPS Status (ASCII HEX), please note UPSMAN status bytes table below	1
110	U	3 / 4	BATTVOLT	Battery Voltage V	1
111	U	3 / 4	INFREQ0	Input Frequency Hz Phase 1	1
112	U	3 / 4	INFREQ1	Input Frequency Hz Phase 2	1
113	U	3 / 4	INFREQ2	Input Frequency Hz Phase 3	1
114	U	3 / 4	CNT_PF	Powerfail Counter	1
115	U	3 / 4	(SNMPALARMS&0x1)	Alarm Battery Bad	1
116	U	3 / 4	(SNMPALARMS&0x2)>>1	Alarm: On Battery	1
117	U	3 / 4	(SNMPALARMS&0x4)>>2	Alarm: Battery Low	1
118	U	3 / 4	(SNMPALARMS&0x8)>>3	Alarm: Battery Depleted	1
119	U	3 / 4	(SNMPALARMS&0x10)>>4	Alarm: Over temperature	1
120	U	3 / 4	(SNMPALARMS&0x20)>>5	Alarm: Input Bad	1
121	U	3 / 4	(SNMPALARMS&0x40)>>6	Alarm: Output Bad	1
122	U	3 / 4	(SNMPALARMS&0x80)>>7	Alarm: Output Overload	1
123	U	3 / 4	(SNMPALARMS&0x100)>>8	Alarm: On Bypass	1
124	U	3 / 4	(SNMPALARMS&0x200)>>9	Alarm: Bypass Bad	1
125	U	3 / 4	(SNMPALARMS&0x400)>>10	Alarm: Output Off as requested.	1
126	U	3 / 4	(SNMPALARMS&0x800)>>11	Alarm: UPS Off as requested.	1
127	U	3 / 4	(SNMPALARMS&0x1000)>>12	Alarm: Charger Failed	1
128	U	3 / 4	(SNMPALARMS&0x2000)>>13	Alarm: UPS Output Off	1
129	U	3 / 4	(SNMPALARMS&0x4000)>>14	Alarm: UPS System Off	1
130	U	3 / 4	(SNMPALARMS&0x8000)>>15	Alarm: Fan Failure	1
131	U	3 / 4	(SNMPALARMS&0x10000)>>1	Alarm: fuse failure	1
132	U	3 / 4	(SNMPALARMS&0x20000)>>1	Alarm: general fault	1
133	U	3 / 4	(SNMPALARMS&0x40000)>>1	Alarm: diagnose test failed	1
134	U	3 / 4	(SNMPALARMS&0x80000)>>1	Alarm: communication lost	1
135	U	3 / 4	(SNMPALARMS&0x100000)>>	Alarm: awaiting power	1
136	U	3 / 4	(SNMPALARMS&0x200000)>>	Alarm: shutdown pending	1
137	U	3 / 4	(SNMPALARMS&0x400000)>>	Alarm: shutdown imminent	1
138	U	3 / 4	(SNMPALARMS&0x800000)>>	Alarm: test in progress	1
139	U	3 / 4	AUX1STATE	AUX Port 1	1
140	U	3 / 4	AUX2STATE	AUX Port 2	1
141	U	3 / 4	AUX3STATE	AUX Port 3	1
142	U	3 / 4	AUX4STATE	AUX Port 4	1
143	U	3 / 4	TEMP1	Sensormanager/SMTCOM sensor 1	1
144	U	3 / 4	TEMP2	Sensormanager/SMTHCOM sensor 2	1
145	U	3 / 4	TEMP3	Sensormanager sensor 3	1
146	U	3 / 4	TEMP4	Sensormanager sensor 4	1
147	U	3 / 4	TEMP5	Sensormanager sensor 5	1
148	U	3 / 4	TEMP6	Sensormanager sensor 6	1
149	U	3 / 4	TEMP7	Sensormanager sensor 7	1
150	U	3 / 4	TEMP8	Sensormanager sensor 8	1
151	U	3 / 4	AEESerModulePresent(1)	Status data, for details contact Effekta	1
152	U	3 / 4	AEESerModulePresent(2)	Status data, for details contact Effekta	1
153	U	3 / 4	AEESerModulePresent(3)	Status data, for details contact Effekta	1
154	U	3 / 4	AEESerModulePresent(4)	Status data, for details contact Effekta	1

Address	Type	Function	Name	Description	Length
155	U	3 / 4	AEESerModulePresent(5)	Status data, for details contact Effekta	1
156	U	3 / 4	AEESerModulePresent(6)	Status data, for details contact Effekta	1
157	U	3 / 4	AEESerModuleError(1,1)	Status data, for details contact Effekta	1
158	U	3 / 4	AEESerModuleError(1,2)	Status data, for details contact Effekta	1
159	U	3 / 4	AEESerModuleError(1,3)	Status data, for details contact Effekta	1
160	U	3 / 4	AEESerModuleError(1,4)	Status data, for details contact Effekta	1
161	U	3 / 4	AEESerModuleError(2,1)	Status data, for details contact Effekta	1
162	U	3 / 4	AEESerModuleError(2,2)	Status data, for details contact Effekta	1
163	U	3 / 4	AEESerModuleError(2,3)	Status data, for details contact Effekta	1
164	U	3 / 4	AEESerModuleError(2,4)	Status data, for details contact Effekta	1
165	U	3 / 4	AEESerModuleError(3,1)	Status data, for details contact Effekta	1
166	U	3 / 4	AEESerModuleError(3,2)	Status data, for details contact Effekta	1
167	U	3 / 4	AEESerModuleError(3,3)	Status data, for details contact Effekta	1
168	U	3 / 4	AEESerModuleError(3,4)	Status data, for details contact Effekta	1
169	U	3 / 4	AEESerModuleError(4,1)	Status data, for details contact Effekta	1
170	U	3 / 4	AEESerModuleError(4,2)	Status data, for details contact Effekta	1
171	U	3 / 4	AEESerModuleError(4,3)	Status data, for details contact Effekta	1
172	U	3 / 4	AEESerModuleError(4,4)	Status data, for details contact Effekta	1
173	U	3 / 4	AEESerModuleError(5,1)	Status data, for details contact Effekta	1
174	U	3 / 4	AEESerModuleError(5,2)	Status data, for details contact Effekta	1
175	U	3 / 4	AEESerModuleError(5,3)	Status data, for details contact Effekta	1
176	U	3 / 4	AEESerModuleError(5,4)	Status data, for details contact Effekta	1
177	U	3 / 4	AEESerModuleError(6,1)	Status data, for details contact Effekta	1
178	U	3 / 4	AEESerModuleError(6,2)	Status data, for details contact Effekta	1
179	U	3 / 4	AEESerModuleError(6,3)	Status data, for details contact Effekta	1
180	U	3 / 4	AEESerModuleError(6,4)	Status data, for details contact Effekta	1
181	U	3 / 4	AEESerModuleWarning(1)	Status data, for details contact Effekta	1
182	U	3 / 4	AEESerModuleWarning(2)	Status data, for details contact Effekta	1
183	U	3 / 4	AEESerModuleWarning(3)	Status data, for details contact Effekta	1
184	U	3 / 4	AEESerModuleWarning(4)	Status data, for details contact Effekta	1
185	U	3 / 4	AEESerModuleWarning(5)	Status data, for details contact Effekta	1
186	U	3 / 4	AEESerModuleWarning(6)	Status data, for details contact Effekta	1
187	U	3 / 4	AEESerModuleState(1)	Status data, for details contact Effekta	1
188	U	3 / 4	AEESerModuleState(2)	Status data, for details contact Effekta	1
189	U	3 / 4	AEESerModuleState(3)	Status data, for details contact Effekta	1
190	U	3 / 4	AEESerModuleState(4)	Status data, for details contact Effekta	1
191	U	3 / 4	AEESerModuleState(5)	Status data, for details contact Effekta	1
192	U	3 / 4	AEESerModuleState(6)	Status data, for details contact Effekta	1
193	U	3 / 4	AEESerModuleVolt(1)	Status data, for details contact Effekta	1
194	U	3 / 4	AEESerModuleVolt(2)	Status data, for details contact Effekta	1
195	U	3 / 4	AEESerModuleVolt(3)	Status data, for details contact Effekta	1
196	U	3 / 4	AEESerModuleVolt(4)	Status data, for details contact Effekta	1
197	U	3 / 4	AEESerModuleVolt(5)	Status data, for details contact Effekta	1
198	U	3 / 4	AEESerModuleVolt(6)	Status data, for details contact Effekta	1
199	U	3 / 4	AEESerModuleCurr(1)	Status data, for details contact Effekta	1
200	U	3 / 4	AEESerModuleCurr(2)	Status data, for details contact Effekta	1
201	U	3 / 4	AEESerModuleCurr(3)	Status data, for details contact Effekta	1
202	U	3 / 4	AEESerModuleCurr(4)	Status data, for details contact Effekta	1
203	U	3 / 4	AEESerModuleCurr(5)	Status data, for details contact Effekta	1
204	U	3 / 4	AEESerModuleCurr(6)	Status data, for details contact Effekta	1
205	U	3 / 4	seconbat	Time on Battery [sec.]	1

Address	Type	Function	Name	Description	Length
206	U	3 / 4	OUTPUT_VOLT0	Output Voltage [V]	1
207	U	3 / 4	E_OUTPOWER*10.0	Enigma total output power [KW]	1
208	U	3 / 4	E_OUTCPOWER*10.0	Enigma total output compl. power [KVA]	1

Section Borri 4000 Std. Panel / E-Tec 310 to 380 (m) / SALICRU SLC NX/DL/CUBE

Address	Type	Function	Name	Description	Length
1	U	3 / 4	Manufacturer	Manufacturer	1
17	U	3 / 4	Version	Version	1
33	U	3 / 4	Identification	Identification	1
65	U	3 / 4	Model	Model	1
97	U	3 / 4	AUTONOMTIME	Autonomy time in minutes	1
98	U	3 / 4	BATTCAP	Battery capacity in percent	1
99	U	3 / 4	OUTPUT	Output Source 0 Mains, 1 Battery, 2 Bypass	1
100	U	3 / 4	OUTFREQ0	Output Frequency	1
101	U	3 / 4	SOLAWROV0	Outputvoltage Phase 1 in V	1
102	U	3 / 4	SOLAWROV1	Outputvoltage Phase 2 in V	1
103	U	3 / 4	SOLAWROV2	Outputvoltage Phase 3 in V	1
104	U	3 / 4	SOLAWROC0	Output Current Phase 1 in A	1
105	U	3 / 4	SOLAWROC1	Output Current Phase 2 in A	1
106	U	3 / 4	SOLAWROC2	Output Current Phase 3 in A	1
107	U	3 / 4	OUTPOWER0	Outpower Phase 1 %	1
108	U	3 / 4	OUTPOWER1	Outpower Phase 2 %	1
109	U	3 / 4	OUTPOWER2	Outpower Phase 3 %	1
110	U	3 / 4	SOLSETEMPBAD	Temperature bad	1
111	U	3 / 4	SOLSEINPUTBAD	Input bad	1
112	U	3 / 4	SOLSEOVERLOAD	Overload	1
113	U	3 / 4	SOLSEBYPASSFAULT	Bypass fault	1
114	U	3 / 4	SOLSECHARGERFAULT	Charger fault	1
115	U	3 / 4	SOLSEGENERALFAULT	General fault	1
116	U	3 / 4	SOLSESDPENDING	Shutdown pending	1
117	U	3 / 4	SOLSETESTRESULT	Test result	1
118	U	3 / 4	(SNMPALARMS&0x80000)>>19	Communication Lost Alarm	1
119	U	3 / 4	INFREQ0	Input Frequency Phase 1 in Hz	1
120	U	3 / 4	INFREQ1	Input Frequency Phase 2 in Hz	1
121	U	3 / 4	INFREQ2	Input Frequency Phase 3 in Hz	1
122	U	3 / 4	INVOLT0	Input Voltage Phase 1 in V	1

123	U	3 / 4	INVOLT1	Input Voltage Phase 2 in V	1
124	U	3 / 4	INVOLT2	Input Voltage Phase 3 in V	1
125	U	3 / 4	INCURRO	Input Current Phase 1 in A	1
126	U	3 / 4	INCURR1	Input Current Phase 2 in A	1
127	U	3 / 4	INCURR2	Input Current Phase 3 in A	1
128	U	3 / 4	EX_BYP_VOLT0	Bypass Voltage Phase 1 in V	1
129	U	3 / 4	EX_BYP_VOLT1	Bypass Voltage Phase 2 in V	1
130	U	3 / 4	EX_BYP_VOLT2	Bypass Voltage Phase 3 in V	1
131	U	3 / 4	EX_BYP_CURR0	Bypass Current Phase 1 in A	1
132	U	3 / 4	EX_BYP_CURR1	Bypass Current Phase 2 in A	1
133	U	3 / 4	EX_BYP_CURR2	Bypass Current Phase 3 in A	1
134	U	3 / 4	EX_BYP_WATT0	Bypass Power Phase 1 [W]	1
135	U	3 / 4	EX_BYP_WATT1	Bypass Power Phase 2 [W]	1
136	U	3 / 4	EX_BYP_WATT2	Bypass Power Phase 3 [W]	1
137	U	3 / 4	EX_BYP_FREQ0	Bypass Frequency [Hz]	1
138	U	3 / 4	EX_INP_WATT0	Input Power Phase 1 [W]	1
139	U	3 / 4	EX_INP_WATT1	Input Power Phase 2 [W]	1
140	U	3 / 4	EX_INP_WATT2	Input Power Phase 3 [W]	1
141	U	3 / 4	BATTVOLT	Battery Voltage [V]	1
142	U	3 / 4	TEMPDEG	Temperature [°C]	1
143	U	3 / 4	EX_BATT_SECONBATT	Time on Battery [sec.]	1
144	U	3 / 4	EX_BATT_CURRPOS	positive battery current [A]	1
145	U	3 / 4	BATTCONDITION	Flags for battery condition	1
146	U	3 / 4	INPHASES	amount of Phases at Input	1
147	U	3 / 4	OUTPHASES	amount of Phases at Output	1
148	U	3 / 4	SOLABATTC	Battery Current [A]	1

Section Inform UPS / Pyramid DSP/Online DSP

Address	Type	Function	Name	Description	Length
100	U	3 / 4	OUTPOWER0	Outpower Phase 1 %	1
101	U	3 / 4	OUTPOWER1	Outpower Phase 2 %	1
102	U	3 / 4	OUTPOWER2	Outpower Phase 3 %	1
103	U	3 / 4	BATTCAP	Battery Capacity %	1
104	S	3 / 4	INVOLT0	Input Voltage Phase 1 V	1
105	S	3 / 4	INVOLT1	Input Voltage Phase 2 V	1
106	S	3 / 4	INVOLT2	Input Voltage Phase 3 V	1
107	S	3 / 4	TEMPDEG	Temperature C°	1

108	S	3 / 4	AUTONOMTIME	Autonomy Time minutes	1
109	U	3 / 4	STATUS (e. g. UPS normal = "4", Powerfail = "12", Battery test running = "68", Bypass = "5")	UPS Status (ASCII HEX) Please note UPSMAN status bytes table below	1
110	S	3 / 4	BATTVOLT	Battery Voltage V	1
111	U	3 / 4	INFREQ0	Input Frequency Hz Phase 1	1
112	U	3 / 4	INFREQ1	Input Frequency Hz Phase 2	1
113	U	3 / 4	INFREQ2	Input Frequency Hz Phase 3	1
114	U	3 / 4	CNT_PF	Powerfail Counter	1
115	U	3 / 4	Alarm Battery Bad	1 = active; 0 = not active	1
116	U	3 / 4	Alarm: On Battery	1 = active; 0 = not active	1
117	U	3 / 4	Alarm: Battery Low	1 = active; 0 = not active	1
118	U	3 / 4	Alarm: Battery Depleted	1 = active; 0 = not active	1
119	U	3 / 4	Alarm: Over temperature	1 = active; 0 = not active	1
120	U	3 / 4	Alarm: Input Bad	1 = active; 0 = not active	1
121	U	3 / 4	Alarm: Output Bad	1 = active; 0 = not active	1
122	U	3 / 4	Alarm: Output Overload	1 = active; 0 = not active	1
123	U	3 / 4	Alarm: On Bypass	1 = active; 0 = not active	1
124	U	3 / 4	Alarm: Bypass Bad	1 = active; 0 = not active	1
125	U	3 / 4	Alarm: Output Off as requested.	1 = active; 0 = not active	1
126	U	3 / 4	Alarm: UPS Off as requested.	1 = active; 0 = not active	1
127	U	3 / 4	Alarm: Charger Failed	1 = active; 0 = not active	1
128	U	3 / 4	Alarm: UPS Output Off	1 = active; 0 = not active	1
129	U	3 / 4	Alarm: UPS System Off	1 = active; 0 = not active	1
130	U	3 / 4	Alarm: Fan Failure	1 = active; 0 = not active	1
131	U	3 / 4	Alarm: fuse failure	1 = active; 0 = not active	1
132	U	3 / 4	Alarm: general fault	1 = active; 0 = not active	1
133	U	3 / 4	Alarm: diagnose test failed	1 = active; 0 = not active	1
134	U	3 / 4	Alarm: communication lost	1 = active; 0 = not active	1
135	U	3 / 4	Alarm: awaiting power	1 = active; 0 = not active	1
136	U	3 / 4	Alarm: shutdown pending	1 = active; 0 = not active	1
137	U	3 / 4	Alarm: shutdown imminent	1 = active; 0 = not active	1
138	U	3 / 4	Alarm: test in progress	1 = active; 0 = not active	1
139	U	3 / 4	AUX Port 1	1 = active (high), 0 = not active (low)	1
140	U	3 / 4	AUX Port 2	1 = active (high), 0 = not active (low)	1
141	U	3 / 4	AUX Port 3	1 = active (high), 0 = not active (low)	1
142	U	3 / 4	AUX Port 4	1 = active (high), 0 = not active (low)	1

143	U	3 / 4	Sensormanager/SMTCOM sensor 1	Analog value	1
144	U	3 / 4	Sensormanager/SMTHCOM sensor 2	Analog value	1
145	U	3 / 4	Sensormanager sensor 3	Analog value	1
146	U	3 / 4	Sensormanager sensor 4	Analog value	1
147	U	3 / 4	Sensormanager sensor 5	Analog value	1
148	U	3 / 4	Sensormanager sensor 6	Analog value	1
149	U	3 / 4	Sensormanager sensor 7	Analog value	1
150	U	3 / 4	Sensormanager sensor 8	Analog value	1
151	U	3 / 4	OUTPUT_VOLT0	Outputvoltage Phase 1	1
152	U	3 / 4	OUTPUT_VOLT1	Outputvoltage Phase 2	1
153	U	3 / 4	OUTPUT_VOLT2	Outputvoltage Phase 3	1
154	U	3 / 4	OUTPUT_CURRENT0	Output Current Phase 1 in Ampere *10	1
155	U	3 / 4	OUTPUT_CURRENT1	Output Current Phase 2 in Ampere *10	1
156	U	3 / 4	OUTPUT_CURRENT2	Output Current Phase 3 in Ampere *10	1

Section Transfer Switches (All Transfer Switch vendors, except PILLER, STS TUMEL)

Address	Type	Function	Name	Description	Length
1	U	3 / 4	Sources Asynchronous	Warning, input current difference, switching might not be possible	1
2	U	3 / 4	Static Switch A Failure	Alarm, switching failure	1
3	U	3 / 4	Static Switch B Failure	Alarm, switching failure	1
4	U	3 / 4	On Static Switch A	Supplied from input A	1
5	U	3 / 4	On Static Switch B	Supplied from input B	1
6	U	3 / 4	On Manual Bypass A	Supplied via bypass from input A	1
7	U	3 / 4	On Manual Bypass A	Supplied via bypass from input B	1
8	U	3 / 4	Source A Failure	Alarm, input A failure, problem with voltage	1
9	U	3 / 4	Source B Failure	Alarm, input B failure, problem with voltage	1
10	U	3 / 4	General Fault	General alarm	1
11	U	3 / 4	Redundancy Lost	Redundancy lost,	1
12	U	3 / 4	Output Overload	To much load	1
13	U	3 / 4	Output Failure	Output failure	1

Section STS TUMEL Transfer Switch

Address	Type	Function	Name	Description	Length
100	U	3 / 4	INPVOLT_NET_10	Input Voltage S1 Phase 1 [V]	1
101	U	3 / 4	INPVOLT_NET_11	Input Voltage S1 Phase 2 [V]	1
102	U	3 / 4	INPVOLT_NET_12	Input Voltage S1 Phase 3 [V]	1
103	U	3 / 4	INFREQ_NET_1	Input Frequency S1 [Hz]	1
104	U	3 / 4	INPVOLT_NET_20	Input Voltage S2 Phase 1 [V]	1
105	U	3 / 4	INPVOLT_NET_21	Input Voltage S2 Phase 2 [V]	1
106	U	3 / 4	INPVOLT_NET_22	Input Voltage S2 Phase 3 [V]	1
107	U	3 / 4	INFREQ_NET_2	Input Frequency S2 [Hz]	1
108	U	3 / 4	STS_SYNCANGLE	Synchron Angle	1
109	U	3 / 4	STS_SYNDIFF	Synchron Difference	1
110	U	3 / 4	STS_S1BALANCE	S1 Phase Balance	1
111	U	3 / 4	STS_S2BALANCE	S2 Phase Balance	1
112	U	3 / 4	TEMPDEG	Temperature [°C]	1
113	U	3 / 4	OUTPUT_VOLT0	Output Voltage Phase 1 [V]	1
114	U	3 / 4	OUTPUT_VOLT1	Output Voltage Phase 2 [V]	1
115	U	3 / 4	OUTPUT_VOLT1	Output Voltage Phase 3 [V]	1
116	U	3 / 4	EX_OUT_CURR0	Output Current Phase 1 [A]	1
117	U	3 / 4	EX_OUT_CURR1	Output Current Phase 2 [A]	1
118	U	3 / 4	EX_OUT_CURR2	Output Current Phase 3 [A]	1
119	U	3 / 4	OUTPOWER0	Output Power Phase 1 [W]	1
120	U	3 / 4	OUTPOWER1	Output Power Phase 2 [W]	1
121	U	3 / 4	OUTPOWER2	Output Power Phase 3 [W]	1
122	U	3 / 4	STS_ALARMS0	Status Byte (for details contact manufacturer)	1
123	U	3 / 4	STS_ALARMS1	Status Byte (for details contact manufacturer)	1
124	U	3 / 4	STS_ALARMS2	Status Byte (for details contact manufacturer)	1
125	U	3 / 4	STS_ALARMS3	Status Byte (for details contact manufacturer)	1
126	U	3 / 4	STS_ALARMS4	Status Byte (for details contact manufacturer)	1
127	U	3 / 4	STS_STATUS_S1	Status S1 OK (1:yes / 0:no)	1
128	U	3 / 4	STS_STATUS_S2	Status S2 OK (1:yes / 0:no)	1
129	U	3 / 4	STS_Status_S1_Pref	S1 is preferred (1: yes / 0: no)	1
130	U	3 / 4	STS_Status_S2_Pref	S2 is preferred (1: yes / 0: no)	1
131	U	3 / 4	STS_Status_Load_Pef	Load on Preferred Source (1 yes / 0 no)	1
132	U	3 / 4	STS_Status_Trans	Transfer possible (0: yes / 1: no)	1

133	U	3 / 4	STS_Status_GF	General Fault (1: yes / 0: no)	1
134	U	3 / 4	STS_Status_OL	Overload (1: yes / 0: no)	1
135	U	3 / 4	STS_Status_OF	Output Failure (1: yes / 0: no)	1

Section OEM TRIMOD

Address	Type	Function	Name	Description	Length
100	U	3 / 4	OUTPOWER0	Outpower Phase 1 %	1
101	U	3 / 4	OUTPOWER1	Outpower Phase 2 %	1
102	U	3 / 4	OUTPOWER2	Outpower Phase 3 %	1
103	U	3 / 4	BATTCAP	Battery capacity in percent	1
104	U	3 / 4	INVOLT0	Input Voltage Phase 1 in V	1
105	U	3 / 4	INVOLT1	Input Voltage Phase 2 in V	1
106	U	3 / 4	INVOLT2	Input Voltage Phase 3 in V	1
107	U	3 / 4	TEMPDEG	Temperature C°	1
108	U	3 / 4	AUTONOMTIME	Autonomy Time minutes	1
109	U	3 / 4	STATUS	GENEREX UPS status	1
110	U	3 / 4	BATTVOLT	Battery Voltage V	1
111	U	3 / 4	INFREQ0	Input Frequency Hz Phase 1	1
112	U	3 / 4	INFREQ1	Input Frequency Hz Phase 2	1
113	U	3 / 4	INFREQ2	Input Frequency Hz Phase 3	1
114	U	3 / 4	CNT_PF	Powerfail Counter	1
115	U	3 / 4	(SNMPALARMS&0x1)	Battery Bad	1
116	U	3 / 4	(SNMPALARMS&0x2)>>1	On Battery	1
117	U	3 / 4	(SNMPALARMS&0x4)>>2	Battery Low	1
118	U	3 / 4	(SNMPALARMS&0x8)>>3	Battery Depleted	1
119	U	3 / 4	(SNMPALARMS&0x10)>>4	Over Temperature	1
120	U	3 / 4	(stoi(TRIMOD_STATUS)&0x8)	Mains Input Fails	1
121	U	3 / 4	(CBSER2ALARM&0x40)>>6	Output Bad	1
122	U	3 / 4	(SNMPALARMS&0x80)>>7	Output Overload	1
123	U	3 / 4	(SNMPALARMS&0x100)>>8	On Bypass	1
124	U	3 / 4	(stoi(TRIMOD_STATUS)&0x8)	Not Supported	1
125	U	3 / 4	(SNMPALARMS&0x2000)>>13	Bypass Bad	1
126	U	3 / 4	(SNMPALARMS&0x4000)>>14	Output Off as requested	1
127	U	3 / 4	(SNMPALARMS&0x1000)>>12	Charger Failed	1
128	U	3 / 4	(SNMPALARMS&0x2000)>>13	UPS Output Off	1
129	U	3 / 4	(SNMPALARMS&0x4000)>>14	UPS System Off	1
130	U	3 / 4	(SNMPALARMS&0x8000)>>15	Fan Failure	1

131	U	3 / 4	(SNMPALARMS&0x10000)>>16	Fuse Failure	1
132	U	3 / 4	(SNMPALARMS&0x20000)>>17	General Fault	1
133	U	3 / 4	(stoi(CP_TESTRESULT)==2)	Diagnose Test Failed	1
134	U	3 / 4	(SNMPALARMS&0x80000)>>19	Communication Lost	1
135	U	3 / 4	(SNMPALARMS&0x100000)>>20	Awaiting Power	1
136	U	3 / 4	(CBSER2ALARM&0x200000)>>2	Shutdown Pending	1
137	U	3 / 4	(CBSER2ALARM&0x400000)>>2	Shutdown Imminent	1
138	U	3 / 4	(SNMPALARMS&0x800000)>>23	Test In Progress	1
139	U	3 / 4	(stoi(TRIMOD_STATUS)&0x10	Manual Bypass Engaged	1
140	U	3 / 4	OUTPUT_VOLT0	Outputvoltage Phase 1	1
141	U	3 / 4	OUTPUT_VOLT1	Outputvoltage Phase 2	1
142	U	3 / 4	OUTPUT_VOLT2	Outputvoltage Phase 3	1
143	U	3 / 4	TRIMOD_OUTCURR0*10.0	Output Current 1	1
144	U	3 / 4	TRIMOD_OUTCURR1*10.0	Output Current 2	1
145	U	3 / 4	TRIMOD_OUTCURR2*10.0	Output Current 3	1
152	U	3 / 4	TEMP1	Sensorman. sensor 1 / SMTCOM	1
153	U	3 / 4	TEMP2	Sensorman. sensor 2 / SMTHCOM	1
154	U	3 / 4	TEMP3	Sensormanager sensor 3	1
155	U	3 / 4	TEMP4	Sensormanager sensor 4	1
156	U	3 / 4	TEMP5	Sensormanager sensor 5	1
157	U	3 / 4	TEMP6	Sensormanager sensor 6	1
158	U	3 / 4	TEMP7	Sensormanager sensor 7	1
159	U	3 / 4	TEMP8	Sensormanager sensor 8	1
160	U	3 / 4	TRIMOD_OUTACTPWR0/1000.0	Output Phase 1	1
161	U	3 / 4	TRIMOD_OUTACTPWR1/1000.0	Output Phase 2	1
162	U	3 / 4	TRIMOD_OUTACTPWR2/1000.0	Output Phase 3	1
163	U	3 / 4	AUX1STATE	AUX Port 1	1
164	U	3 / 4	AUX2STATE	AUX Port 2	1
165	U	3 / 4	AUX3STATE	AUX Port 3	1
166	U	3 / 4	AUX4STATE	AUX Port 4	1

Section: EverExceed Inverter

Address	Type	Function	Name	Description	Length
100	U	3 / 4	TEMPDEG	Temperature in Degrees	1
101	U	3 / 4	INFREQ0	Line frequency	1
102	U	3 / 4	INVOLT0	Line voltage	1
103	U	3 / 4	OUTFREQ0	Frequency	1
104	U	3 / 4	OUTPUT_VOLT0	Output voltage	1
105	U	3 / 4	EX_OUT_VA0	Output power	1
106	U	3 / 4	STATUS	GENEREX UPS status (see below)	1
107	U	3 / 4	EX_EXTSTATUS	Alarm information	1
108	U	3 / 4	STATUS&1	Bypass mode, 1 = on, 0 = off	1
109	U	3 / 4	(STATUS&0x02)>>2	Output active, 1 = on, 0 = off	1
110	U	3 / 4	(STATUS&0x100)>>8	Overload, 1 = on, 0 = off	1
111	U	3 / 4	(STATUS&0x2000)>>13	General alarm, 1 = on, 0 = off	1

UPS Status EverExceed	Hex-Value	Dec-Value	Description
UPS_SB_BYPASS_MODE	0x0001	1	Bypass mode
UPS_SB_OUTPUT_ACT	0x0004	4	Output active
UPS_SB_OUTPUT_HIGH	0x0100	256	Overload
UPS_SB_UPS_FAILED	0x2000	8192	General alarm

Other OEM's : See OEM MODBUS Defaultadress 100 – 146 above

UPSMAN Status Bytes - Standard Device Status Bits

UPS Status	Hex-Value	Dec-Value	Description
UPS_SB_BYPASS_MODE	0x0001	1	power piped thru
UPS_SB_SHUTDOWN	0x0002	2	shutdown ups
UPS_SB_OUTPUT_ACT	0x0004	4	inverter on = UPS OK
UPS_SB_BACKUP_MODE	0x0008	8	battery power
UPS_SB_BATTERY_LOW	0x0010	16	low battery err
UPS_SB_OVER_TEMP	0x0020	32	over temp err
UPS_SB_TEST_ACT	0x0040	64	test in progress
UPS_SB_INPUT_HIGH	0x0080	128	over power err
UPS_SB_OUTPUT_HIGH	0x0100	256	over load err
UPS_SB_INVERTER_FAILURE	0x0200	512	Inverter error
UPS_SB_BATTERY_BAD	0x0400	1024	Battery error
UPS_SB_ECO_MODE	0x0800	2048	eco - bypass
UPS_SB_INVERTER_WARN	0x1000	4096	eco - bypass
UPS_SB_UPS_FAILED	0x2000	8192	prser flag
UPS_SB_COMM_LOST	0x4000	16384	for snmp
UPS_SB_DVG_ALARM	0x8000	32768	SiteManager/SiteMonitor

Example (decimal):

STATUS= „5” means UPS_SB_OUTPUT_ACT (4) + UPS_SB_BYPASS_MODE (1) are active != UPS on Bypass!

STATUS= „12” means UPS_SB_OUTPUT_ACT (4) + UPS_SB_BACKUP_MODE (8) are active != UPS Powerfail!

STATUS= „28” means UPS_SB_OUTPUT_ACT (4) + UPS_SB_BACKUP_MODE (8) + UPS_SB_BATTERY_LOW (16) are active != UPS Powerfail and Battery low!

STATUS= „4” means UPS_SB_OUTPUT_ACT (4) + no other alarms = UPS OK

BACS MODBUS Parameter

Standard BACS – Address Description

Note: the max. number of BACS Modules requestable through MODBUS is 512.

Note: "Type U/S": this defines whether the answer has an algebraic sign (math. +/-) or not. U means "

Address	Type	Function	Name	Description	Length	
Note:						
"Type U/S": this defines whether the answer has an algebraic sign (math. +/-) or not. U means "unsigned". S means "signed", this answer may be positive or negative. For "ref:1 – ref:6", please refer to the BACS value definition reference list below the modbus table.						
1000	U	3 / 4	BACS_Alarm	BACS Alarm Flags, ref:4	1	
1001	U	3 / 4	BACS_ALARM	BACS Alarm Flags, ref:5	1	
1002	U	3 / 4	BACS_ALARM	BACS Alarm Flags, ref:6	1	
1003	U	3 / 4	BACS_NUMSTRINGS	Number of BACS Strings	1	
1004	U	3/4	BACS_NUMMODULES	Total number of BACS modules	1	
<i>This address range describes current and voltage of each single string as configured For the divisor: The String and AC String Current Unit is 0.01 ampere</i>						
1010	S	3 / 4	STRING_01_CUR	String 1 current in Ampere [A] (value/100)	1	
1011	S	3 / 4	BACS_StrSumVolt	String 1 Overall BACS string voltage (value/10)	1	
1012	S	3 / 4	BACS_StrAvgVolt	String 1 Average BACS string voltage (value/1000)	1	
1013	S	3 / 4	BACS_Str_CurrAC	String 1 BACS string current	1	
1014			<RESERVED>	Do not use		
1015	S	3 / 4	STRING_02_CUR	String 2 current in Ampere [A] (value/100)	1	
1016	S	3 / 4	BACS_StrSumVolt	String 2 Overall BACS string voltage (value/10)	1	
1017	S	3 / 4	BACS_StrAvgVolt	String 2 Average BACS string voltage (value/1000)	1	
1018	S	3 / 4	BACS_Str_CurrAC	String 2 BACS string current	1	
1019			<RESERVED>	Do not use		
1020	S	3 / 4	STRING_03_CUR	String 3 current in Ampere [A] (value/100)	1	
1021	S	3 / 4	BACS_StrSumVolt	String 3 Overall BACS string voltage (value/10)	1	
1022	S	3 / 4	BACS_StrAvgVolt	String3 Average BACS string voltage (value/1000)	1	
1023	S	3 / 4	BACS_Str_CurrAC	String 3 BACS string current	1	
1024			<RESERVED>	Do not use		
[...]	[...]	[...]	[...Continue modbus string count until address ...]			[...]
1055	S	3 / 4	STRING_10_CUR	String 10 current in Ampere [A] (value/100)	1	

1056	S	3 / 4	BACS_StrSumVolt	String 10 Overall BACS string voltage (value/10)	1	
1057	S	3 / 4	BACS_StrAvgVolt	String 10 Average BACS string voltage (value/1000)	1	
1058	S	3 / 4	BACS_Str_CurrAC	String 10 BACS string current	1	
1059			<RESERVED>	Do not use		
<i>This address range describes the BACS module modbus address range for module 1-330: Each module section contains 5 measuring values. There is no reserved address between the modules!</i>						
1060	S	3 / 4	MODULE_001_TEMP	Module 1 Temperature in Celsius [°C] (Value/10), ref:1	1	
1061	S	3 / 4	MODULE_001_VOLT	Module 1 Voltage in Volt [V], ref:2	1	
1062	S	3 / 4	MODULE_001_IMPC	Module 1 Impedance in milliOhm [mΩ], ref:3	1	
1063	U	3 / 4	MODULE_001_ALARM	Module 1 Alarm flags, ref:6	1	
1064	S	3 / 4	Module_001_ModBypVoltPc	Module 1 Equalizing / Balancing in %	1	
1065	S	3 / 4	MODULE_002_TEMP	Module 2 Temperature in Celsius [°C], ref:1	1	
1066	S	3 / 4	MODULE_002_VOLT	Module 2 Voltage in Volt [V], ref:2	1	
1067	S	3 / 4	MODULE_002_IMPC	Module 2 Impedance in milliOhm [mΩ], ref:3	1	
1068	U	3 / 4	MODULE_002_ALARM	Module 2 Alarm flags, ref:6	1	
1069	S	3 7 4	Module_002_ModBypVoltPc	Module 2 Equalizing / Balancing in %	1	
1070	S	3 / 4	MODULE_003_TEMP	Module 3 Temperature in Celsius [°C], ref:1	1	
1071	S	3 / 4	MODULE_003_VOLT	Module 3 Voltage in Volt [V], ref:2	1	
1072	S	3 / 4	MODULE_003_IMPC	Module 3 Impedance in milliOhm [mΩ], ref:3	1	
1073	U	3 / 4	MODULE_003_ALARM	Module 3 Alarm flags, ref:6	1	
1074	S	3 / 4	Module_003_ModBypVoltPc	Module 3 Equalizing / Balancing in %	1	
[...]	[...]	[...]	[...Continue modbus BACS module count until address ...]			[...]
2705	S	3 / 4	MODULE_330_TEMP	Module 330 Temperature in Celsius [°C], ref:1	1	
2706	S	3 / 4	MODULE_330_VOLT	Module 330 Voltage in Volt [V], ref:2	1	
2707	S	3 / 4	MODULE_330_IMPC	Module 330 Impedance in milliOhm [mΩ], ref:3	1	
2708	U	3 / 4	MODULE_330_ALARM	Module 330 Alarm flags, ref:6	1	

2709	S	3 / 4	Module_330_ModBypVoltPc	Module 330 <DESCRIPTION>	1	
<i>The following address range describes single string current and voltage for BACS strings 11-16</i>						
2710	S	3 / 4	STRING_11_CUR	String 11 current in Ampere [A]	1	
2711			<RESERVED>	Reserved, do not use		
2712			<RESERVED>	Reserved, do not use		
2713	S	3 / 4	String_11_AC	String 11 voltage	1	
2714			<RESERVED>	Reserved, do not use		
2715	S	3 / 4	STRING_12_CUR	String 12 current in Ampere [A]	1	
2716			<RESERVED>	Reserved, do not use		
2717			<RESERVED>	Reserved, do not use		
2718	S		String_12_AC	String 12 voltage	1	
2719			<RESERVED>	Reserved, do not use		
...	<i>[...Continue modbus BACS String count until address ...]</i>			...
2735	S	3 / 4	STRING_16_CUR	String 16 current in Ampere [A]	1	
2736			<RESERVED>	Reserved, do not use		
2737			<RESERVED>	Reserved, do not use		
2738	S		String_12_AC	String 12 voltage	1	
2739			<RESERVED>	Reserved, do not use		
<i>This address range describes the BACS module modbus address range for module 331-512: Each module section contains 5 measuring values. There is no reserved address between the modules!</i>						
2740	S	3 / 4	MODULE_331_TEMP	Module 331 Temperature in Celsius [°C] (see Temfjasdfashfklashf) ,ref:1	1	
2741	S	3 / 4	MODULE_331_VOLT	Module 331 Voltage in Volt [V] *2	1	
2742	S	3 / 4	MODULE_331_IMPC	Module 331 Impedance in milliOhm [mΩ] ,ref:3	1	
2743	U	3 / 4	MODULE_331_ALARM	Module 331 Alarm flags ,ref:6	1	
2744	S	3 / 4	Module_331_ModBypVoltPc	Module 331 Equalizing / Balancing in %	1	
2745	S	3 / 4	MODULE_332_TEMP	Module 332 Temperature in Celsius [°C] (see Temfjasdfashfklashf) ,ref:1	1	
2746	S	3 / 4	MODULE_332_VOLT	Module 332 Voltage in Volt [V] ,ref:2	1	

2747	S	3 / 4	MODULE_332_IMPC	Module 332 Impedance in milliOhm [mΩ] ,ref:3	1
2748	U	3 / 4	MODULE_332_ALARM	Module 332 Alarm flags ,ref:6	1
2749	S	3 / 4	Module_332_ModBypVoltPc	Module 332 Equalizing / Balancing in %	1
...	<i>[...Continue modbus BACS module count until address ...]</i>		
3645	S	3 / 4	MODULE_512_TEMP	Module 512 Temperature in Celsius [°C] (see Temfjasdfashfklashf) ,ref:1	1
3646	S	3 / 4	MODULE_512_VOLT	Module 512 Voltage in Volt [V] *2	1
3647	S	3 / 4	MODULE_512_IMPC	Module 512 Impedance in milliOhm [mΩ] ,ref:3	1
3648	U	3 / 4	MODULE_512_ALARM	Module 512 Alarm flags ,ref:6	1
3649	S	3 / 4	Module_512_ModBypVoltPc	Module 512 Equalizing / Balancing in %	1
<i>This section describes the GX_R AUX alarm status. Depending on the number of GX_R_AUX you have installed, there are up to 16 possible address numbers.</i>					
3650	S	3 / 4	BACSGXRAuxAlarm(0)	GX_R_AUX 1 Alarm Status 1	1
3651	S	3 / 4	BACSGXRAuxAlarm(1)	GX_R_AUX 1 Alarm Status 2	1
3652	S	3 / 4	BACSGXRAuxAlarm(2)	GX_R_AUX 1 Alarm Status 3	1
3653	S	3 / 4	BACSGXRAuxAlarm(3)	GX_R_AUX 1 Alarm Status 4	1
3654	S	3 / 4	BACSGXRAuxAlarm(4)	GX_R_AUX 2 Alarm Status 1	1
3655	S	3 / 4	BACSGXRAuxAlarm(5)	GX_R_AUX 2 Alarm Status 2	1
3656	S	3 / 4	BACSGXRAuxAlarm(6)	GX_R_AUX 2 Alarm Status 3	1
3657	S	3 / 4	BACSGXRAuxAlarm(7)	GX_R_AUX 2 Alarm Status 4	1
3658	S	3 / 4	BACSGXRAuxAlarm(8)	GX_R_AUX 3 Alarm Status 1	1
3659	S	3 / 4	BACSGXRAuxAlarm(9)	GX_R_AUX 3 Alarm Status 2	1
3660	S	3 / 4	BACSGXRAuxAlarm(10)	GX_R_AUX 3 Alarm Status 3	1
3661	S	3 / 4	BACSGXRAuxAlarm(11)	GX_R_AUX 3 Alarm Status 4	1
3662	S	3 / 4	BACSGXRAuxAlarm(12)	GX_R_AUX 4 Alarm Status 1	1
3663	S	3 / 4	BACSGXRAuxAlarm(13)	GX_R_AUX 4 Alarm Status 2	1
3664	S	3 / 4	BACSGXRAuxAlarm(14)	GX_R_AUX 4 Alarm Status 3	1
3665	S	3 / 4	BACSGXRAuxAlarm(15)	GX_R_AUX 4 Alarm Status 4	1
<i>This section describes the GXR_AUX Output status. Depending on the Number of GX_R_AUX you have installed, there are up to 16 possible address numbers.</i>					
3666	S	3 / 4	BACSGXRAuxOutputStatus(0)	GX_R_AUX 1 Output Status 1	1

3667	S	3 / 4	BACSGXRAuxOutputStatus(1)	GX_R_AUX 1 Output Status 2	1
3668	S	3 / 4	BACSGXRAuxOutputStatus(2)	GX_R_AUX 1 Output Status 3	1
3669	S	3 / 4	BACSGXRAuxOutputStatus(3)	GX_R_AUX 1 Output Status 4	1
3670	S	3 / 4	BACSGXRAuxOutputStatus(4)	GX_R_AUX 2 Output Status 1	1
3671	S	3 / 4	BACSGXRAuxOutputStatus(5)	GX_R_AUX 2 Output Status 2	1
3672	S	3 / 4	BACSGXRAuxOutputStatus(6)	GX_R_AUX 2 Output Status 3	1
3673	S	3 / 4	BACSGXRAuxOutputStatus(7)	GX_R_AUX 2 Output Status 4	1
3674	S	3 / 4	BACSGXRAuxOutputStatus(8)	GX_R_AUX 3 Output Status 1	1
3675	S	3 / 4	BACSGXRAuxOutputStatus(9)	GX_R_AUX 3 Output Status 2	1
3676	S	3 / 4	BACSGXRAuxOutputStatus(10)	GX_R_AUX 3 Output Status 3	1
3677	S	3 / 4	BACSGXRAuxOutputStatus(11)	GX_R_AUX 3 Output Status 4	1
3678	S	3 / 4	BACSGXRAuxOutputStatus(12)	GX_R_AUX 4 Output Status 1	1
3679	S	3 / 4	BACSGXRAuxOutputStatus(13)	GX_R_AUX 4 Output Status 2	1
3680	S	3 / 4	BACSGXRAuxOutputStatus(14)	GX_R_AUX 4 Output Status 3	1
3681	S	3 / 4	BACSGXRAuxOutputStatus(15)	GX_R_AUX 4 Output Status 4	1

Note: A value of -1 or -9999 means: This value is currently "Not available" ("N/A").

BACS value definition reference list:

ref:1 - Temperature value definition:

$$\text{Temperature } T \text{ in } ^\circ\text{C} \quad T = \frac{X-78}{2} \quad \text{e.g.} \quad T = \frac{128-78}{2} = 25$$

0xXX → 0 bis 255

0x7F 127 => 24,5°C

0x80 128 => 25°C

0x81 129 => 25,5°C

ref:2 - Voltage value definition:

Voltage U in V Value / 1000

e.g. **Voltage U in V** = 12825 / 1000 = 12,825 V

ref:3 - Impedance value definition:

Impedance Z in mΩ Value / 100

e.g. **Impedance Z in mΩ** = 4372 / 1000 = 43,72 mΩ

ref:4 - Address 1000 MODBUS: hexadecimal / decimal

Address 1000: MODBUS	hexadecimal	decimal	BIN
BACS_STATE_NONE	0x0000	0	0000 0000 0000 0000
BACS_STATE_RUNNING	0x0001	1	0000 0000 0000 0001
BACS_STATE_CONNECTED	0x0002	2	0000 0000 0000 0010
BACS_STATE_MODULE_LOST	0x0004	4	0000 0000 0000 0100
BACS_STATE_DISCHARGING	0x0008	8	0000 0000 0000 1000
BACS_STATE_CHARGING	0x0010	16	0000 0000 0001 0000
BACS_STATE_DISCHARGING_STOPPED	0x0020	32	0000 0000 0010 0000
BACS_STATE_FLOAT_CHARGING	0x0040	64	0000 0000 0100 0000
BACS_STATE_EQUALISATION	0x0080	128	0000 0000 1000 0000
BACS_STATE_SYSTEM_FAILURE	0x0100	256	0000 0001 0000 0000
BACS_STATE_VOLTAGE_OUTOFRANGE	0x0200	512	0000 0010 0000 0000
BACS_STATE_TEMPERATURE_OUTOFRANGE	0x0400	1024	0000 0100 0000 0000
BACS_STATE_RESISTOR-OUTOFRANGE	0x0800	2048	0000 1000 0000 0000
BACS_STATE_MODULE-ADDRESSING	0x1000	4096	0001 0000 0000 0000
BACS_STATE_MODULE-SEARCHING	0x2000	8192	0010 0000 0000 0000
BACS_STATE_MODULE-INITIALIZING	0x4000	16384	0100 0000 0000 0000
BACS_STATE_MODULE-POLLING	0x8000	32768	1000 0000 0000 0000

ref:5 - Address 1001 MODBUS: hexadecimal / decimal

Address 1001: MODBUS	hexadecimal	decimal	BIN
BACS_STATE-GENERAL-ALARM	0x0001	1	0000 0000 0000 0000
BACS_STATE-VOLTAGE-DIFF-HIGH	0x0002	2	0000 0000 0000 0001
BACS_STATE-BATTERY-BREAKER-OPEN	0x0004	4	0000 0000 0000 0010
BACS_STATE_THERMAL_RUNAWAY	0x0008	8	0000 0000 0000 0100
BACS_STATE_SENSOR_LOST	0x0010	16	0000 0000 0000 1000
BACS_STATE_STRING_VOLTAGE_HIGH	0x0020	32	0000 0000 0001 0000
BACS_STATE_STRING_VOLTAGE_LOW	0x0040	64	0000 0000 0010 0000
BACS_STATE_STRING_VOLTAGE_WARNING_HIGH	0x0080	128	0000 0000 0100 0000
BACS_STATE_STRING_VOLTAGE_WARNING_LOW	0x0100	256	0000 0000 1000 0000
BACS_STATE_STRING_CURRENT_HIGH	0x0200	512	0000 0001 0000 0000
BACS_STATE_STRING_CURRENT_LOW	0x0400	1024	0000 0010 0000 0000
BACS_STATE_STRING_CURRENT_WARNING_HIGH	0x0800	2048	0000 0100 0000 0000
BACS_STATE_STRING_CURRENT_WARNING_LOW	0x1000	4096	0000 1000 0000 0000
BACS_STATE_CURRENT_OUTOFRANGE	0x2000	8192	0001 0000 0000 0000
BACS_STATE_CURRENT_GROUND_FAULT_DETECTED	0x4000	16384	0010 0000 0000 0000

ref:6 – Address 1002 MODBUS Alarm Flags: hexadecimal / decimal

Address 1002: MODBUS Alarm Flags	hexadecimal	decimal	BIN
BACS_ALARM_NONE	0x0000	0	0000 0000 0000 0000
BACS_ALARM_GENERAL_ALARM	0x0001	1	0000 0000 0000 0001
BACS_ALARM_COMMUNICATION_LOST	0x0002	2	0000 0000 0000 0010
CS_ALARM_VOLTAGE_HIGH	0x0004	4	0000 0000 0000 0100
BACS_ALARM_VOLTAGE_LOW	0x0008	8	0000 0000 0000 1000
BACS_ALARM_TEMPERATURE_HIGH	0x0010	16	0000 0000 0001 0000
BACS_ALARM_TEMPERATURE_LOW	0x0020	32	0000 0000 0010 0000
BACS_ALARM_RESISTOR_HIGH	0x0040	64	0000 0000 0100 0000
BACS_ALARM_RESISTOR_LOW	0x0080	128	0000 0000 1000 0000
BACS_ALARM_EQUALISATION_ERR	0x0100	256	0000 0001 0000 0000
BACS_ALARM_VOLTAGE_WARN_HIGH	0x0200	512	0000 0010 0000 0000
BACS_ALARM_VOLTAGE_WARN_LOW	0x0400	1024	0000 0100 0000 0000
BACS_ALARM_TEMPERATURE_WARN_HIGH	0x0800	2048	0000 1000 0000 0000
BACS_ALARM_TEMPERATURE_WARN_LOW	0x1000	4096	0001 0000 0000 0000
BACS_ALARM_RESISTOR_WARN_HIGH	0x2000	8192	0010 0000 0000 0000
BACS_ALARM_RESISTOR_WARN_LOW	0x4000	16384	0100 0000 0000 0000
BACS_ALARM_MODREV_INCOMPATIBLE	0x8000	32768	1000 0000 0000 0000

RFC 1628 MIB Overview

The following table provides an overview of the RFC 1628 MIB from 18.01.2024. The latest overview and MIB file is available for download in our download area at www.generex.de.

ups MIB RFC1628

- 1.3.6.1.2.1 mib2
- 1.3.6.1.2.1.33 upsMIB
- 1.3.6.1.2.1.33.1 upsObjects
- 1.3.6.1.2.1.33.1.1 upsIdent
- 1.3.6.1.2.1.33.1.1.1 upsIdentManufacturer
- 1.3.6.1.2.1.33.1.1.2 upsIdentModel
- 1.3.6.1.2.1.33.1.1.3 upsIdentUPSSoftwareVersion
- 1.3.6.1.2.1.33.1.1.4 upsIdentAgentSoftwareVersion
- 1.3.6.1.2.1.33.1.1.5 upsIdentName
- 1.3.6.1.2.1.33.1.1.6 upsIdentAttachedDevices
- 1.3.6.1.2.1.33.1.1.7 upsSerialNumber
- 1.3.6.1.2.1.33.1.1.8 upsLocation
- 1.3.6.1.2.1.33.1.1.9 upsSystemContact
- 1.3.6.1.2.1.33.1.2 upsBattery
- 1.3.6.1.2.1.33.1.2.1 upsBatteryStatus
- 1.3.6.1.2.1.33.1.2.2 upsSecondsOnBattery
- 1.3.6.1.2.1.33.1.2.3 upsEstimatedMinutesRemaining
- 1.3.6.1.2.1.33.1.2.4 upsEstimatedChargeRemaining
- 1.3.6.1.2.1.33.1.2.5 upsBatteryVoltage
- 1.3.6.1.2.1.33.1.2.6 upsBatteryCurrent
- 1.3.6.1.2.1.33.1.2.7 upsBatteryTemperature
- 1.3.6.1.2.1.33.1.2.8 upsBatteryCondition
- 1.3.6.1.2.1.33.1.2.9 upsBatteryInstallationDate
- 1.3.6.1.2.1.33.1.2.10 upsBatteryPositiveVoltage
- 1.3.6.1.2.1.33.1.2.11 upsBatteryNegativeVoltage

1.3.6.1.2.1.33.1.2.12 upsBatteryPositiveCurrent
 1.3.6.1.2.1.33.1.2.13 upsBatteryNegativeCurrent
 1.3.6.1.2.1.33.1.3 upsInput
 1.3.6.1.2.1.33.1.3.1 upsInputLineBads
 1.3.6.1.2.1.33.1.3.2 upsInputNumLines
 1.3.6.1.2.1.33.1.3.3 upsInputTable
 1.3.6.1.2.1.33.1.3.3.1 upsInputEntry
 1.3.6.1.2.1.33.1.3.3.1.1 upsInputLineIndex
 1.3.6.1.2.1.33.1.3.3.1.2 upsInputFrequency
 1.3.6.1.2.1.33.1.3.3.1.3 upsInputVoltage
 1.3.6.1.2.1.33.1.3.3.1.4 upsInputCurrent
 1.3.6.1.2.1.33.1.3.3.1.5 upsInputTruePower
 1.3.6.1.2.1.33.1.4 upsOutput
 1.3.6.1.2.1.33.1.4.1 upsOutputSource
 1.3.6.1.2.1.33.1.4.2 upsOutputFrequency
 1.3.6.1.2.1.33.1.4.3 upsOutputNumLines
 1.3.6.1.2.1.33.1.4.4 upsOutputTable
 1.3.6.1.2.1.33.1.4.4.1 upsOutputEntry
 1.3.6.1.2.1.33.1.4.4.1.1 upsOutputLineIndex
 1.3.6.1.2.1.33.1.4.4.1.2 upsOutputVoltage
 1.3.6.1.2.1.33.1.4.4.1.3 upsOutputCurrent
 1.3.6.1.2.1.33.1.4.4.1.4 upsOutputPower
 1.3.6.1.2.1.33.1.4.4.1.5 upsOutputPercentLoad
 1.3.6.1.2.1.33.1.4.5 upsOutputEnergyConsumption
 1.3.6.1.2.1.33.1.5 upsBypass
 1.3.6.1.2.1.33.1.5.1 upsBypassFrequency
 1.3.6.1.2.1.33.1.5.2 upsBypassNumLines
 1.3.6.1.2.1.33.1.5.3 upsBypassTable
 1.3.6.1.2.1.33.1.5.3.1 upsBypassEntry
 1.3.6.1.2.1.33.1.5.3.1.1 upsBypassLineIndex
 1.3.6.1.2.1.33.1.5.3.1.2 upsBypassVoltage
 1.3.6.1.2.1.33.1.5.3.1.3 upsBypassCurrent
 1.3.6.1.2.1.33.1.5.3.1.4 upsBypassPower
 1.3.6.1.2.1.33.1.6 upsAlarm
 1.3.6.1.2.1.33.1.6.1 upsAlarmsPresent
 1.3.6.1.2.1.33.1.6.2 upsAlarmTable
 1.3.6.1.2.1.33.1.6.2.1 upsAlarmEntry
 1.3.6.1.2.1.33.1.6.2.1.1 upsAlarmId
 1.3.6.1.2.1.33.1.6.2.1.2 upsAlarmDescr
 1.3.6.1.2.1.33.1.6.2.1.3 upsAlarmTime
 1.3.6.1.2.1.33.1.6.3 upsWellKnownAlarms
 1.3.6.1.2.1.33.1.6.3.1 upsAlarmBatteryBad
 1.3.6.1.2.1.33.1.6.3.2 upsAlarmOnBattery
 1.3.6.1.2.1.33.1.6.3.3 upsAlarmLowBattery
 1.3.6.1.2.1.33.1.6.3.4 upsAlarmDepletedBattery
 1.3.6.1.2.1.33.1.6.3.5 upsAlarmTempBad
 1.3.6.1.2.1.33.1.6.3.6 upsAlarmInputBad
 1.3.6.1.2.1.33.1.6.3.7 upsAlarmOutputBad
 1.3.6.1.2.1.33.1.6.3.8 upsAlarmOutputOverload
 1.3.6.1.2.1.33.1.6.3.9 upsAlarmOnBypass
 1.3.6.1.2.1.33.1.6.3.10 upsAlarmBypassBad
 1.3.6.1.2.1.33.1.6.3.11 upsAlarmOutputOffAsRequested
 1.3.6.1.2.1.33.1.6.3.12 upsAlarmUpsOffAsRequested

1.3.6.1.2.1.33.1.6.3.13 upsAlarmChargerFailed
1.3.6.1.2.1.33.1.6.3.14 upsAlarmUpsOutputOff
1.3.6.1.2.1.33.1.6.3.15 upsAlarmUpsSystemOff
1.3.6.1.2.1.33.1.6.3.16 upsAlarmFanFailure
1.3.6.1.2.1.33.1.6.3.17 upsAlarmFuseFailure
1.3.6.1.2.1.33.1.6.3.18 upsAlarmGeneralFault
1.3.6.1.2.1.33.1.6.3.19 upsAlarmDiagnosticTestFailed
1.3.6.1.2.1.33.1.6.3.20 upsAlarmCommunicationsLost
1.3.6.1.2.1.33.1.6.3.21 upsAlarmAwaitingPower
1.3.6.1.2.1.33.1.6.3.22 upsAlarmShutdownPending
1.3.6.1.2.1.33.1.6.3.23 upsAlarmShutdownImminent
1.3.6.1.2.1.33.1.6.3.24 upsAlarmTestInProgress
1.3.6.1.2.1.33.1.6.3.25 upsAlarmAuxInput1
1.3.6.1.2.1.33.1.6.3.26 upsAlarmAuxInput2
1.3.6.1.2.1.33.1.6.3.27 upsAlarmAuxInput3
1.3.6.1.2.1.33.1.6.3.28 upsAlarmAuxInput4
1.3.6.1.2.1.33.1.6.3.29 alarmSiteManagerDigitalInput1
1.3.6.1.2.1.33.1.6.3.30 alarmSiteManagerDigitalInput2
1.3.6.1.2.1.33.1.6.3.31 alarmSiteManagerDigitalInput3
1.3.6.1.2.1.33.1.6.3.32 alarmSiteManagerDigitalInput4
1.3.6.1.2.1.33.1.6.3.33 alarmSiteManagerDigitalInput5
1.3.6.1.2.1.33.1.6.3.34 alarmSiteManagerDigitalInput6
1.3.6.1.2.1.33.1.6.3.35 alarmSiteManagerDigitalInput7
1.3.6.1.2.1.33.1.6.3.36 alarmSiteManagerDigitalInput8
1.3.6.1.2.1.33.1.6.3.37 alarmSiteManagerAnalogInput1
1.3.6.1.2.1.33.1.6.3.38 alarmSiteManagerAnalogInput2
1.3.6.1.2.1.33.1.6.3.39 alarmSiteManagerAnalogInput3
1.3.6.1.2.1.33.1.6.3.40 alarmSiteManagerAnalogInput4
1.3.6.1.2.1.33.1.6.3.41 alarmSiteManagerAnalogInput5
1.3.6.1.2.1.33.1.6.3.42 alarmSiteManagerAnalogInput6
1.3.6.1.2.1.33.1.6.3.43 alarmSiteManagerAnalogInput7
1.3.6.1.2.1.33.1.6.3.44 alarmSiteManagerAnalogInput8
1.3.6.1.2.1.33.1.6.3.45 alarmSiteManagerAnalogMarker1
1.3.6.1.2.1.33.1.6.3.46 alarmSiteManagerAnalogMarker2
1.3.6.1.2.1.33.1.6.3.47 alarmSiteManagerAnalogMarker3
1.3.6.1.2.1.33.1.6.3.48 alarmSiteManagerAnalogMarker4
1.3.6.1.2.1.33.1.6.3.49 alarmSiteManagerAnalogMarker5
1.3.6.1.2.1.33.1.6.3.50 alarmSiteManagerAnalogMarker6
1.3.6.1.2.1.33.1.6.3.51 alarmSiteManagerAnalogMarker7
1.3.6.1.2.1.33.1.6.3.52 alarmSiteManagerAnalogMarker8
1.3.6.1.2.1.33.1.6.3.53 alarmSiteManagerOutput1
1.3.6.1.2.1.33.1.6.3.54 alarmSiteManagerOutput2
1.3.6.1.2.1.33.1.6.3.55 alarmSiteManagerOutput3
1.3.6.1.2.1.33.1.6.3.56 alarmSiteManagerOutput4
1.3.6.1.2.1.33.1.6.3.57 alarmSiteManagerOutput5
1.3.6.1.2.1.33.1.6.3.58 alarmSiteManagerOutput6
1.3.6.1.2.1.33.1.6.3.59 alarmSiteManagerOutput7
1.3.6.1.2.1.33.1.6.3.60 alarmSiteManagerOutput8
1.3.6.1.2.1.33.1.6.3.61 alarmSiteMonitor1
1.3.6.1.2.1.33.1.6.3.62 alarmSiteMonitor2
1.3.6.1.2.1.33.1.6.3.63 alarmSiteMonitor3
1.3.6.1.2.1.33.1.6.3.64 alarmSiteMonitor4
1.3.6.1.2.1.33.1.6.3.65 alarmSiteMonitor5

1.3.6.1.2.1.33.1.6.3.66 alarmSiteMonitor6
1.3.6.1.2.1.33.1.6.3.67 alarmSiteMonitor7
1.3.6.1.2.1.33.1.6.3.68 alarmSiteMonitor8
1.3.6.1.2.1.33.1.6.3.69 alarmSiteMonitor9
1.3.6.1.2.1.33.1.6.3.70 alarmSiteMonitor10
1.3.6.1.2.1.33.1.6.3.71 alarmSiteMonitor11
1.3.6.1.2.1.33.1.6.3.72 alarmSiteMonitor12
1.3.6.1.2.1.33.1.6.3.73 alarmSiteMonitor13
1.3.6.1.2.1.33.1.6.3.74 alarmSiteMonitor14
1.3.6.1.2.1.33.1.6.3.75 alarmSiteMonitor15
1.3.6.1.2.1.33.1.6.3.76 alarmSiteMonitor16
1.3.6.1.2.1.33.1.6.3.77 alarmSiteMonitor17
1.3.6.1.2.1.33.1.6.3.78 alarmSiteMonitor18
1.3.6.1.2.1.33.1.6.3.79 alarmSiteMonitor19
1.3.6.1.2.1.33.1.6.3.80 alarmSiteMonitor20
1.3.6.1.2.1.33.1.6.3.81 alarmSiteMonitor21
1.3.6.1.2.1.33.1.6.3.82 alarmSiteMonitor22
1.3.6.1.2.1.33.1.6.3.83 alarmSiteMonitor23
1.3.6.1.2.1.33.1.6.3.84 alarmSiteMonitor24
1.3.6.1.2.1.33.1.6.3.85 alarmSiteMonitor25
1.3.6.1.2.1.33.1.6.3.86 alarmSiteMonitor26
1.3.6.1.2.1.33.1.6.3.87 alarmSiteMonitor27
1.3.6.1.2.1.33.1.6.3.88 alarmSiteMonitor28
1.3.6.1.2.1.33.1.6.3.89 alarmSiteMonitor29
1.3.6.1.2.1.33.1.6.3.90 alarmSiteMonitor30
1.3.6.1.2.1.33.1.6.3.91 alarmSiteMonitor31
1.3.6.1.2.1.33.1.6.3.92 alarmSiteMonitor32
1.3.6.1.2.1.33.1.6.3.93 alarmSiteMonitor33
1.3.6.1.2.1.33.1.6.3.94 alarmSiteMonitor34
1.3.6.1.2.1.33.1.6.3.95 alarmSiteMonitor35
1.3.6.1.2.1.33.1.6.3.96 alarmSiteMonitor36
1.3.6.1.2.1.33.1.6.3.97 alarmSiteMonitor37
1.3.6.1.2.1.33.1.6.3.98 alarmSiteMonitor38
1.3.6.1.2.1.33.1.6.3.99 alarmSiteMonitor39
1.3.6.1.2.1.33.1.6.3.100 alarmSiteMonitor40
1.3.6.1.2.1.33.1.6.3.101 alarmSiteMonitor41
1.3.6.1.2.1.33.1.6.3.102 alarmSiteMonitor42
1.3.6.1.2.1.33.1.6.3.103 alarmSiteMonitor43
1.3.6.1.2.1.33.1.6.3.104 alarmSiteMonitor44
1.3.6.1.2.1.33.1.6.3.105 alarmSiteMonitor45
1.3.6.1.2.1.33.1.6.3.106 alarmSiteMonitor46
1.3.6.1.2.1.33.1.6.3.107 alarmSiteMonitor47
1.3.6.1.2.1.33.1.6.3.108 alarmSiteMonitor48
1.3.6.1.2.1.33.1.6.3.109 alarmSiteMonitor49
1.3.6.1.2.1.33.1.6.3.110 alarmSiteMonitor50
1.3.6.1.2.1.33.1.6.3.111 alarmSiteMonitor51
1.3.6.1.2.1.33.1.6.3.112 alarmSiteMonitor52
1.3.6.1.2.1.33.1.6.3.113 alarmSiteMonitor53
1.3.6.1.2.1.33.1.6.3.114 alarmSiteMonitor54
1.3.6.1.2.1.33.1.6.3.115 alarmSiteMonitor55
1.3.6.1.2.1.33.1.6.3.116 alarmSiteMonitor56
1.3.6.1.2.1.33.1.6.3.117 alarmSiteMonitor57
1.3.6.1.2.1.33.1.6.3.118 alarmSiteMonitor58

1.3.6.1.2.1.33.1.6.3.119 alarmSiteMonitor59
 1.3.6.1.2.1.33.1.6.3.120 alarmSiteMonitor60
 1.3.6.1.2.1.33.1.6.3.121 alarmSiteMonitor61
 1.3.6.1.2.1.33.1.6.3.122 alarmSiteMonitor62
 1.3.6.1.2.1.33.1.6.3.123 alarmSiteMonitor63
 1.3.6.1.2.1.33.1.6.3.124 alarmSiteMonitor64
 1.3.6.1.2.1.33.1.6.3.125 alarmSensorManager1Low
 1.3.6.1.2.1.33.1.6.3.126 alarmSensorManager2Low
 1.3.6.1.2.1.33.1.6.3.127 alarmSensorManager3Low
 1.3.6.1.2.1.33.1.6.3.128 alarmSensorManager4Low
 1.3.6.1.2.1.33.1.6.3.129 alarmSensorManager5Low
 1.3.6.1.2.1.33.1.6.3.130 alarmSensorManager6Low
 1.3.6.1.2.1.33.1.6.3.131 alarmSensorManager7Low
 1.3.6.1.2.1.33.1.6.3.132 alarmSensorManager8Low
 1.3.6.1.2.1.33.1.6.3.133 alarmSensorManager1High
 1.3.6.1.2.1.33.1.6.3.134 alarmSensorManager2High
 1.3.6.1.2.1.33.1.6.3.135 alarmSensorManager3High
 1.3.6.1.2.1.33.1.6.3.136 alarmSensorManager4High
 1.3.6.1.2.1.33.1.6.3.137 alarmSensorManager5High
 1.3.6.1.2.1.33.1.6.3.138 alarmSensorManager6High
 1.3.6.1.2.1.33.1.6.3.139 alarmSensorManager7High
 1.3.6.1.2.1.33.1.6.3.140 alarmSensorManager8High
 1.3.6.1.2.1.33.1.6.3.141 alarmUser1
 1.3.6.1.2.1.33.1.6.3.142 alarmUser2
 1.3.6.1.2.1.33.1.6.3.143 alarmUser3
 1.3.6.1.2.1.33.1.6.3.144 alarmUser4
 1.3.6.1.2.1.33.1.6.3.145 alarmUser5
 1.3.6.1.2.1.33.1.6.3.146 alarmUser6
 1.3.6.1.2.1.33.1.6.3.147 alarmUser7
 1.3.6.1.2.1.33.1.6.3.148 statusDischarging
 1.3.6.1.2.1.33.1.6.3.149 statusCharging
 1.3.6.1.2.1.33.1.6.3.150 alarmSensorManagerInput1
 1.3.6.1.2.1.33.1.6.3.151 alarmSensorManagerInput2
 1.3.6.1.2.1.33.1.6.3.152 alarmSensorManagerInput3
 1.3.6.1.2.1.33.1.6.3.153 alarmSensorManagerInput4
 1.3.6.1.2.1.33.1.6.3.154 alarmSensorManagerOutput1
 1.3.6.1.2.1.33.1.6.3.155 alarmSensorManagerOutput2
 1.3.6.1.2.1.33.1.6.3.156 alarmSensorManagerOutput3
 1.3.6.1.2.1.33.1.6.3.157 alarmSensorManagerOutput4
 1.3.6.1.2.1.33.1.6.3.158 alarmSensorComLost
 1.3.6.1.2.1.33.1.6.3.159 alarmVuesWindalarm
 1.3.6.1.2.1.33.1.6.3.160 alarmTransferswitchSourcesAsynchronous
 1.3.6.1.2.1.33.1.6.3.161 alarmTransferswitchStaticSwitchAFailure
 1.3.6.1.2.1.33.1.6.3.162 alarmTransferswitchStaticSwitchBFailure
 1.3.6.1.2.1.33.1.6.3.163 alarmTransferswitchOnStaticSwitchA
 1.3.6.1.2.1.33.1.6.3.164 alarmTransferswitchOnStaticSwitchB
 1.3.6.1.2.1.33.1.6.3.165 alarmTransferswitchOnManualBypassA
 1.3.6.1.2.1.33.1.6.3.166 alarmTransferswitchOnManualBypassB
 1.3.6.1.2.1.33.1.6.3.167 alarmTransferswitchSourceAFailure
 1.3.6.1.2.1.33.1.6.3.168 alarmTransferswitchSourceBFailure
 1.3.6.1.2.1.33.1.6.3.169 alarmTransferswitchGeneralFault
 1.3.6.1.2.1.33.1.6.3.170 alarmTransferswitchRedundancyLost
 1.3.6.1.2.1.33.1.6.3.171 alarmTransferswitchOutputOverload

1.3.6.1.2.1.33.1.6.3.172 alarmBlackBoxReady
 1.3.6.1.2.1.33.1.6.3.173 upsAlarmInputAuxBad
 1.3.6.1.2.1.33.1.6.3.174 upsAlarmThresholdAlarm
 1.3.6.1.2.1.33.1.6.3.175 upsAlarmThresholdWarning
 1.3.6.1.2.1.33.1.6.3.176 upsAlarmTestFailed
 1.3.6.1.2.1.33.1.6.3.177 upsAlarmBatteryWeak
 1.3.6.1.2.1.33.1.6.3.178 upsAlarmGeneratorOn
 1.3.6.1.2.1.33.1.6.3.179 upsAlarmRedundancyLost
 1.3.6.1.2.1.33.1.6.3.180 upsAlarmBatteryTooOld
 1.3.6.1.2.1.33.1.7 upsTest
 1.3.6.1.2.1.33.1.7.1 upsTestId
 1.3.6.1.2.1.33.1.7.2 upsTestSpinLock
 1.3.6.1.2.1.33.1.7.3 upsTestResultsSummary
 1.3.6.1.2.1.33.1.7.4 upsTestResultsDetail
 1.3.6.1.2.1.33.1.7.5 upsTestStartTime
 1.3.6.1.2.1.33.1.7.6 upsTestElapsedTime
 1.3.6.1.2.1.33.1.7.7 upsWellKnownTests
 1.3.6.1.2.1.33.1.7.7.1 upsTestNoTestsInitiated
 1.3.6.1.2.1.33.1.7.7.2 upsTestAbortTestInProgress
 1.3.6.1.2.1.33.1.7.7.3 upsTestGeneralSystemsTest
 1.3.6.1.2.1.33.1.7.7.4 upsTestQuickBatteryTest
 1.3.6.1.2.1.33.1.7.7.5 upsTestDeepBatteryCalibration
 1.3.6.1.2.1.33.1.8 upsControl
 1.3.6.1.2.1.33.1.8.1 upsShutdownType
 1.3.6.1.2.1.33.1.8.2 upsShutdownAfterDelay
 1.3.6.1.2.1.33.1.8.3 upsStartupAfterDelay
 1.3.6.1.2.1.33.1.8.4 upsRebootWithDuration
 1.3.6.1.2.1.33.1.8.5 upsAutoRestart
 1.3.6.1.2.1.33.1.8.6 UpsVarIdIn Read/Write "for internal purpose only - do not overwrite "
 1.3.6.1.2.1.33.1.8.7 UpsVarIdOut Read only "for internal purpose only"
 1.3.6.1.2.1.33.1.9 upsConfig
 1.3.6.1.2.1.33.1.9.1 upsConfigInputVoltage
 1.3.6.1.2.1.33.1.9.2 upsConfigInputFreq
 1.3.6.1.2.1.33.1.9.3 upsConfigOutputVoltage
 1.3.6.1.2.1.33.1.9.4 upsConfigOutputFreq
 1.3.6.1.2.1.33.1.9.5 upsConfigOutputVA
 1.3.6.1.2.1.33.1.9.6 upsConfigOutputPower
 1.3.6.1.2.1.33.1.9.7 upsConfigLowBattTime
 1.3.6.1.2.1.33.1.9.8 upsConfigAudibleStatus
 1.3.6.1.2.1.33.1.9.9 upsConfigLowVoltageTransferPoint
 1.3.6.1.2.1.33.1.9.10 upsConfigHighVoltageTransferPoint
 1.3.6.1.2.1.33.1.10 sitemanager
 1.3.6.1.2.1.33.1.10.1 relais
 1.3.6.1.2.1.33.1.10.1.1 relais1
 1.3.6.1.2.1.33.1.10.1.2 relais2
 1.3.6.1.2.1.33.1.10.1.3 relais3
 1.3.6.1.2.1.33.1.10.1.4 relais4
 1.3.6.1.2.1.33.1.10.1.5 relais5
 1.3.6.1.2.1.33.1.10.1.6 relais6
 1.3.6.1.2.1.33.1.10.1.7 relais7
 1.3.6.1.2.1.33.1.10.1.8 relais8
 1.3.6.1.2.1.33.1.10.2 digital
 1.3.6.1.2.1.33.1.10.2.1 digital1

1.3.6.1.2.1.33.1.10.2.2 digital2
1.3.6.1.2.1.33.1.10.2.3 digital3
1.3.6.1.2.1.33.1.10.2.4 digital4
1.3.6.1.2.1.33.1.10.2.5 digital5
1.3.6.1.2.1.33.1.10.2.6 digital6
1.3.6.1.2.1.33.1.10.2.7 digital7
1.3.6.1.2.1.33.1.10.2.8 digital8
1.3.6.1.2.1.33.1.10.3 analog
1.3.6.1.2.1.33.1.10.3.1 analog1
1.3.6.1.2.1.33.1.10.3.2 analog1Min
1.3.6.1.2.1.33.1.10.3.3 analog1Max
1.3.6.1.2.1.33.1.10.3.4 analog2
1.3.6.1.2.1.33.1.10.3.5 analog2Min
1.3.6.1.2.1.33.1.10.3.6 analog2Max
1.3.6.1.2.1.33.1.10.3.7 analog3
1.3.6.1.2.1.33.1.10.3.8 analog3Min
1.3.6.1.2.1.33.1.10.3.9 analog3Max
1.3.6.1.2.1.33.1.10.3.10 analog4
1.3.6.1.2.1.33.1.10.3.11 analog4Min
1.3.6.1.2.1.33.1.10.3.12 analog4Max
1.3.6.1.2.1.33.1.10.3.13 analog5
1.3.6.1.2.1.33.1.10.3.14 analog5Min
1.3.6.1.2.1.33.1.10.3.15 analog5Max
1.3.6.1.2.1.33.1.10.3.16 analog6
1.3.6.1.2.1.33.1.10.3.17 analog6Min
1.3.6.1.2.1.33.1.10.3.18 analog6Max
1.3.6.1.2.1.33.1.10.3.19 analog7
1.3.6.1.2.1.33.1.10.3.20 analog7Min
1.3.6.1.2.1.33.1.10.3.21 analog7Max
1.3.6.1.2.1.33.1.10.3.22 analog8
1.3.6.1.2.1.33.1.10.3.23 analog8Min
1.3.6.1.2.1.33.1.10.3.24 analog8Max
1.3.6.1.2.1.33.1.10.4 marker
1.3.6.1.2.1.33.1.10.4.1 marker1
1.3.6.1.2.1.33.1.10.4.2 marker2
1.3.6.1.2.1.33.1.10.4.3 marker3
1.3.6.1.2.1.33.1.10.4.4 marker4
1.3.6.1.2.1.33.1.10.4.5 marker5
1.3.6.1.2.1.33.1.10.4.6 marker6
1.3.6.1.2.1.33.1.10.4.7 marker7
1.3.6.1.2.1.33.1.10.4.8 marker8
1.3.6.1.2.1.33.1.10.5 siteMonitor
1.3.6.1.2.1.33.1.10.5.1 siteMonitor1
1.3.6.1.2.1.33.1.10.5.2 siteMonitor2
1.3.6.1.2.1.33.1.10.5.3 siteMonitor3
1.3.6.1.2.1.33.1.10.5.4 siteMonitor4
1.3.6.1.2.1.33.1.10.5.5 siteMonitor5
1.3.6.1.2.1.33.1.10.5.6 siteMonitor6
1.3.6.1.2.1.33.1.10.5.7 siteMonitor7
1.3.6.1.2.1.33.1.10.5.8 siteMonitor8
1.3.6.1.2.1.33.1.10.5.9 siteMonitor9
1.3.6.1.2.1.33.1.10.5.10 siteMonitor10
1.3.6.1.2.1.33.1.10.5.11 siteMonitor11

- 1.3.6.1.2.1.33.1.10.5.12 siteMonitor12
- 1.3.6.1.2.1.33.1.10.5.13 siteMonitor13
- 1.3.6.1.2.1.33.1.10.5.14 siteMonitor14
- 1.3.6.1.2.1.33.1.10.5.15 siteMonitor15
- 1.3.6.1.2.1.33.1.10.5.16 siteMonitor16
- 1.3.6.1.2.1.33.1.10.5.17 siteMonitor17
- 1.3.6.1.2.1.33.1.10.5.18 siteMonitor18
- 1.3.6.1.2.1.33.1.10.5.19 siteMonitor19
- 1.3.6.1.2.1.33.1.10.5.20 siteMonitor20
- 1.3.6.1.2.1.33.1.10.5.21 siteMonitor21
- 1.3.6.1.2.1.33.1.10.5.22 siteMonitor22
- 1.3.6.1.2.1.33.1.10.5.23 siteMonitor23
- 1.3.6.1.2.1.33.1.10.5.24 siteMonitor24
- 1.3.6.1.2.1.33.1.10.5.25 siteMonitor25
- 1.3.6.1.2.1.33.1.10.5.26 siteMonitor26
- 1.3.6.1.2.1.33.1.10.5.27 siteMonitor27
- 1.3.6.1.2.1.33.1.10.5.28 siteMonitor28
- 1.3.6.1.2.1.33.1.10.5.29 siteMonitor29
- 1.3.6.1.2.1.33.1.10.5.30 siteMonitor30
- 1.3.6.1.2.1.33.1.10.5.31 siteMonitor31
- 1.3.6.1.2.1.33.1.10.5.32 siteMonitor32
- 1.3.6.1.2.1.33.1.10.5.33 siteMonitor33
- 1.3.6.1.2.1.33.1.10.5.34 siteMonitor34
- 1.3.6.1.2.1.33.1.10.5.35 siteMonitor35
- 1.3.6.1.2.1.33.1.10.5.36 siteMonitor36
- 1.3.6.1.2.1.33.1.10.5.37 siteMonitor37
- 1.3.6.1.2.1.33.1.10.5.38 siteMonitor38
- 1.3.6.1.2.1.33.1.10.5.39 siteMonitor39
- 1.3.6.1.2.1.33.1.10.5.40 siteMonitor40
- 1.3.6.1.2.1.33.1.10.5.41 siteMonitor41
- 1.3.6.1.2.1.33.1.10.5.42 siteMonitor42
- 1.3.6.1.2.1.33.1.10.5.43 siteMonitor43
- 1.3.6.1.2.1.33.1.10.5.44 siteMonitor44
- 1.3.6.1.2.1.33.1.10.5.45 siteMonitor45
- 1.3.6.1.2.1.33.1.10.5.46 siteMonitor46
- 1.3.6.1.2.1.33.1.10.5.47 siteMonitor47
- 1.3.6.1.2.1.33.1.10.5.48 siteMonitor48
- 1.3.6.1.2.1.33.1.10.5.49 siteMonitor49
- 1.3.6.1.2.1.33.1.10.5.50 siteMonitor50
- 1.3.6.1.2.1.33.1.10.5.51 siteMonitor51
- 1.3.6.1.2.1.33.1.10.5.52 siteMonitor52
- 1.3.6.1.2.1.33.1.10.5.53 siteMonitor53
- 1.3.6.1.2.1.33.1.10.5.54 siteMonitor54
- 1.3.6.1.2.1.33.1.10.5.55 siteMonitor55
- 1.3.6.1.2.1.33.1.10.5.56 siteMonitor56
- 1.3.6.1.2.1.33.1.10.5.57 siteMonitor57
- 1.3.6.1.2.1.33.1.10.5.58 siteMonitor58
- 1.3.6.1.2.1.33.1.10.5.59 siteMonitor59
- 1.3.6.1.2.1.33.1.10.5.60 siteMonitor60
- 1.3.6.1.2.1.33.1.10.5.61 siteMonitor61
- 1.3.6.1.2.1.33.1.10.5.62 siteMonitor62
- 1.3.6.1.2.1.33.1.10.5.63 siteMonitor63
- 1.3.6.1.2.1.33.1.10.5.64 siteMonitor64

1.3.6.1.2.1.33.1.11 aux
1.3.6.1.2.1.33.1.11.1 auxPort1
1.3.6.1.2.1.33.1.11.2 auxPort2
1.3.6.1.2.1.33.1.11.3 auxPort3
1.3.6.1.2.1.33.1.11.4 auxPort4
1.3.6.1.2.1.33.1.12 sensorMan
1.3.6.1.2.1.33.1.12.1 sensor1
1.3.6.1.2.1.33.1.12.1.1 sensorMan1Value
1.3.6.1.2.1.33.1.12.1.2 sensorMan1Location
1.3.6.1.2.1.33.1.12.1.3 sensorMan1Unit
1.3.6.1.2.1.33.1.12.1.4 sensorMan1ThresholdLow
1.3.6.1.2.1.33.1.12.1.5 sensorMan1ThresholdHigh
1.3.6.1.2.1.33.1.12.1.6 sensorMan1Scaling
1.3.6.1.2.1.33.1.12.1.7 sensorMan1Offset
1.3.6.1.2.1.33.1.12.2 sensor2
1.3.6.1.2.1.33.1.12.2.1 sensorMan2Value
1.3.6.1.2.1.33.1.12.2.2 sensorMan2Location
1.3.6.1.2.1.33.1.12.2.3 sensorMan2Unit
1.3.6.1.2.1.33.1.12.2.4 sensorMan2ThresholdLow
1.3.6.1.2.1.33.1.12.2.5 sensorMan2ThresholdHigh
1.3.6.1.2.1.33.1.12.2.6 sensorMan2Scaling
1.3.6.1.2.1.33.1.12.2.7 sensorMan2Offset
1.3.6.1.2.1.33.1.12.3 sensor3
1.3.6.1.2.1.33.1.12.3.1 sensorMan3Value
1.3.6.1.2.1.33.1.12.3.2 sensorMan3Location
1.3.6.1.2.1.33.1.12.3.3 sensorMan3Unit
1.3.6.1.2.1.33.1.12.3.4 sensorMan3ThresholdLow
1.3.6.1.2.1.33.1.12.3.5 sensorMan3ThresholdHigh
1.3.6.1.2.1.33.1.12.3.6 sensorMan3Scaling
1.3.6.1.2.1.33.1.12.3.7 sensorMan3Offset
1.3.6.1.2.1.33.1.12.4 sensor4
1.3.6.1.2.1.33.1.12.4.1 sensorMan4Value
1.3.6.1.2.1.33.1.12.4.2 sensorMan4Location
1.3.6.1.2.1.33.1.12.4.3 sensorMan4Unit
1.3.6.1.2.1.33.1.12.4.4 sensorMan4ThresholdLow
1.3.6.1.2.1.33.1.12.4.5 sensorMan4ThresholdHigh
1.3.6.1.2.1.33.1.12.4.6 sensorMan4Scaling
1.3.6.1.2.1.33.1.12.4.7 sensorMan4Offset
1.3.6.1.2.1.33.1.12.5 sensor5
1.3.6.1.2.1.33.1.12.5.1 sensorMan5Value
1.3.6.1.2.1.33.1.12.5.2 sensorMan5Location
1.3.6.1.2.1.33.1.12.5.3 sensorMan5Unit
1.3.6.1.2.1.33.1.12.5.4 sensorMan5ThresholdLow
1.3.6.1.2.1.33.1.12.5.5 sensorMan5ThresholdHigh
1.3.6.1.2.1.33.1.12.5.6 sensorMan5Scaling
1.3.6.1.2.1.33.1.12.5.7 sensorMan5Offset
1.3.6.1.2.1.33.1.12.6 sensor6
1.3.6.1.2.1.33.1.12.6.1 sensorMan6Value
1.3.6.1.2.1.33.1.12.6.2 sensorMan6Location
1.3.6.1.2.1.33.1.12.6.3 sensorMan6Unit
1.3.6.1.2.1.33.1.12.6.4 sensorMan6ThresholdLow
1.3.6.1.2.1.33.1.12.6.5 sensorMan6ThresholdHigh
1.3.6.1.2.1.33.1.12.6.6 sensorMan6Scaling

1.3.6.1.2.1.33.1.12.6.7 sensorMan6Offset
1.3.6.1.2.1.33.1.12.7 sensor7
1.3.6.1.2.1.33.1.12.7.1 sensorMan7Value
1.3.6.1.2.1.33.1.12.7.2 sensorMan7Location
1.3.6.1.2.1.33.1.12.7.3 sensorMan7Unit
1.3.6.1.2.1.33.1.12.7.4 sensorMan7ThresholdLow
1.3.6.1.2.1.33.1.12.7.5 sensorMan7ThresholdHigh
1.3.6.1.2.1.33.1.12.7.6 sensorMan7Scaling
1.3.6.1.2.1.33.1.12.7.7 sensorMan7Offset
1.3.6.1.2.1.33.1.12.8 sensor8
1.3.6.1.2.1.33.1.12.8.1 sensorMan8Value
1.3.6.1.2.1.33.1.12.8.2 sensorMan8Location
1.3.6.1.2.1.33.1.12.8.3 sensorMan8Unit
1.3.6.1.2.1.33.1.12.8.4 sensorMan8ThresholdLow
1.3.6.1.2.1.33.1.12.8.5 sensorMan8ThresholdHigh
1.3.6.1.2.1.33.1.12.8.6 sensorMan8Scaling
1.3.6.1.2.1.33.1.12.8.7 sensorMan8Offset
1.3.6.1.2.1.33.1.12.9 input1
1.3.6.1.2.1.33.1.12.9.1 input1Value
1.3.6.1.2.1.33.1.12.9.2 input1Location
1.3.6.1.2.1.33.1.12.9.3 input1NCContact
1.3.6.1.2.1.33.1.12.10 input2
1.3.6.1.2.1.33.1.12.10.1 input2Value
1.3.6.1.2.1.33.1.12.10.2 input2Location
1.3.6.1.2.1.33.1.12.10.3 input2NCContact
1.3.6.1.2.1.33.1.12.11 input3
1.3.6.1.2.1.33.1.12.11.1 input3Value
1.3.6.1.2.1.33.1.12.11.2 input3Location
1.3.6.1.2.1.33.1.12.11.3 input3NCContact
1.3.6.1.2.1.33.1.12.12 input4
1.3.6.1.2.1.33.1.12.12.1 input4Value
1.3.6.1.2.1.33.1.12.12.2 input4Location
1.3.6.1.2.1.33.1.12.12.3 inputNCContact
1.3.6.1.2.1.33.1.12.13 output1
1.3.6.1.2.1.33.1.12.13.1 output1Value
1.3.6.1.2.1.33.1.12.13.2 output1Location
1.3.6.1.2.1.33.1.12.13.3 output1NCContact
1.3.6.1.2.1.33.1.12.14 output2
1.3.6.1.2.1.33.1.12.14.1 output2Value
1.3.6.1.2.1.33.1.12.14.2 output2Location
1.3.6.1.2.1.33.1.12.14.3 output2NCContact
1.3.6.1.2.1.33.1.12.15 output3
1.3.6.1.2.1.33.1.12.15.1 output3Value
1.3.6.1.2.1.33.1.12.15.2 output3Location
1.3.6.1.2.1.33.1.12.15.3 output3NCContact
1.3.6.1.2.1.33.1.12.16 output4
1.3.6.1.2.1.33.1.12.16.1 output4Value
1.3.6.1.2.1.33.1.12.16.2 output4Location
1.3.6.1.2.1.33.1.12.16.3 outputNCContact
1.3.6.1.2.1.33.1.13 sts
1.3.6.1.2.1.33.1.13.1 stsStaticSwitch1On
1.3.6.1.2.1.33.1.13.2 stsStaticSwitch2On
1.3.6.1.2.1.33.1.13.3 stsManualBypass1On

1.3.6.1.2.1.33.1.13.4 stsManualBypass2On
 1.3.6.1.2.1.33.1.13.5 stsAutoTransfermode
 1.3.6.1.2.1.33.1.13.6 stsSourcesSynchron
 1.3.6.1.2.1.33.1.13.7 stsPreferedMains1
 1.3.6.1.2.1.33.1.13.8 stsPreferedMains2
 1.3.6.1.2.1.33.1.13.9 stsAutostartEnabled
 1.3.6.1.2.1.33.1.14 upsInputAux
 1.3.6.1.2.1.33.1.14.1 upsInputAuxBads
 1.3.6.1.2.1.33.1.14.2 upsInputAuxNumLines
 1.3.6.1.2.1.33.1.14.3 upsInputAuxTable
 1.3.6.1.2.1.33.1.14.3.1 upsInputAuxEntry
 1.3.6.1.2.1.33.1.14.3.1.1 upsInputAuxIndex
 1.3.6.1.2.1.33.1.14.3.1.2 upsInputAuxFrequency
 1.3.6.1.2.1.33.1.14.3.1.3 upsInputAuxVoltage
 1.3.6.1.2.1.33.1.14.3.1.4 upsInputAuxCurrent
 1.3.6.1.2.1.33.1.14.3.1.5 upsInputAuxTruePower
 1.3.6.1.2.1.33.1.15 additionalValues
 1.3.6.1.2.1.33.1.15.1 externalSensor
 1.3.6.1.2.1.33.2 upsTraps
 1.3.6.1.2.1.33.2.1 upsTrapOnBattery
 1.3.6.1.2.1.33.2.2 upsTrapTestCompleted
 1.3.6.1.2.1.33.2.3 upsTrapAlarmEntryAdded
 1.3.6.1.2.1.33.2.4 upsTrapAlarmEntryRemoved
 1.3.6.1.2.1.33.3 upsConformance
 1.3.6.1.2.1.33.3.1 upsCompliances
 1.3.6.1.2.1.33.3.1.1 upsSubsetCompliance
 1.3.6.1.2.1.33.3.1.2 upsBasicCompliance
 1.3.6.1.2.1.33.3.1.3 upsFullCompliance
 1.3.6.1.2.1.33.3.2 upsGroups
 1.3.6.1.2.1.33.3.2.1 upsSubsetGroups
 1.3.6.1.2.1.33.3.2.1.1 upsSubsetIdentGroup
 1.3.6.1.2.1.33.3.2.1.2 upsSubsetBatteryGroup
 1.3.6.1.2.1.33.3.2.1.3 upsSubsetInputGroup
 1.3.6.1.2.1.33.3.2.1.4 upsSubsetOutputGroup
 1.3.6.1.2.1.33.3.2.1.6 upsSubsetAlarmGroup
 1.3.6.1.2.1.33.3.2.1.8 upsSubsetControlGroup
 1.3.6.1.2.1.33.3.2.1.9 upsSubsetConfigGroup
 1.3.6.1.2.1.33.3.2.2 upsBasicGroups
 1.3.6.1.2.1.33.3.2.2.1 upsBasicIdentGroup
 1.3.6.1.2.1.33.3.2.2.2 upsBasicBatteryGroup
 1.3.6.1.2.1.33.3.2.2.3 upsBasicInputGroup
 1.3.6.1.2.1.33.3.2.2.4 upsBasicOutputGroup
 1.3.6.1.2.1.33.3.2.2.5 upsBasicBypassGroup
 1.3.6.1.2.1.33.3.2.2.6 upsBasicAlarmGroup
 1.3.6.1.2.1.33.3.2.2.7 upsBasicTestGroup
 1.3.6.1.2.1.33.3.2.2.8 upsBasicControlGroup
 1.3.6.1.2.1.33.3.2.2.9 upsBasicConfigGroup
 1.3.6.1.2.1.33.3.2.3 upsFullGroups
 1.3.6.1.2.1.33.3.2.3.1 upsFullIdentGroup
 1.3.6.1.2.1.33.3.2.3.2 upsFullBatteryGroup
 1.3.6.1.2.1.33.3.2.3.3 upsFullInputGroup
 1.3.6.1.2.1.33.3.2.3.4 upsFullOutputGroup
 1.3.6.1.2.1.33.3.2.3.5 upsFullBypassGroup

1.3.6.1.2.1.33.3.2.3.6 upsFullAlarmGroup
 1.3.6.1.2.1.33.3.2.3.7 upsFullTestGroup
 1.3.6.1.2.1.33.3.2.3.8 upsFullControlGroup
 1.3.6.1.2.1.33.3.2.3.9 upsFullConfigGroup
 1.3.6.1.2.1.33.6.1 upsNumModules
 1.3.6.1.2.1.33.6.2 upsModulesTable
 1.3.6.1.2.1.33.6.2.1.1 upsModuleId
 1.3.6.1.2.1.33.6.2.1.2 upsModuleStatus

RFC 1628 MIB – BACS extension (Stand 18.01.2024)

The following table provides an overview of the RFC 1628 BACS MIB file. For the latest BACS MIB overview and MIB file, visit our download area at www.generex.de.

1.3.6.1.2.1	mib2
1.3.6.1.2.1.33	upsMIB
1.3.6.1.2.1.33.5	bacs2
1.3.6.1.2.1.33.5.1	bacsSettings
1.3.6.1.2.1.33.5.1.1	bacsModuleType
1.3.6.1.2.1.33.5.1.2	bacsNumStrings
1.3.6.1.2.1.33.5.1.3	bacsNumBatteries
1.3.6.1.2.1.33.5.1.4	bacsBattCap
1.3.6.1.2.1.33.5.1.5	bacsLogRate1
1.3.6.1.2.1.33.5.1.6	bacsLogRate
2 1.3.6.1.2.1.33.5.1.7	bacsImpcPollRate
1.3.6.1.2.1.33.5.1.8	bacsImpcLowAlarm
1.3.6.1.2.1.33.5.1.9	bacsImpcHighAlarm
1.3.6.1.2.1.33.5.1.10	bacsTemperatureLowAlarm
1.3.6.1.2.1.33.5.1.11	bacsTemperatureHighAlarm
1.3.6.1.2.1.33.5.1.12	bacsVoltageLowAlarm
1.3.6.1.2.1.33.5.1.13	bacsVoltageHighAlarm
1.3.6.1.2.1.33.5.1.14	bacsImpcLowWarn
1.3.6.1.2.1.33.5.1.15	bacsImpcHighWarn
1.3.6.1.2.1.33.5.1.16	bacsTemperatureLowWarn
1.3.6.1.2.1.33.5.1.17	bacsTemperatureHighWarn
1.3.6.1.2.1.33.5.1.18	bacsVoltageLowWarn
1.3.6.1.2.1.33.5.1.19	bacsVoltageHighWarn
1.3.6.1.2.1.33.5.1.20	bacsTemperatureUnit
1.3.6.1.2.1.33.5.1.21	bacsStringVoltageLowAlarm
1.3.6.1.2.1.33.5.1.22	bacsStringVoltageHighAlarm
1.3.6.1.2.1.33.5.1.23	bacsStringVoltageLowWarn
1.3.6.1.2.1.33.5.1.24	bacsStringVoltageHighWarn
1.3.6.1.2.1.33.5.1.25	bacsStringCurrentDeviationDischargeAlarm
1.3.6.1.2.1.33.5.1.26	bacsStringCurrentDeviationChargeAlarm
1.3.6.1.2.1.33.5.1.27	bacsStringCurrentDeviationDischargeWarn
1.3.6.1.2.1.33.5.1.28	bacsStringCurrentDeviationChargeWarn
1.3.6.1.2.1.33.5.2	bacsObjects
1.3.6.1.2.1.33.5.2.1	bacsStatus* (Definition table below this list)
1.3.6.1.2.1.33.5.2.2	bacsAvModuleVolt
1.3.6.1.2.1.33.5.2.3	bacsTotalVolt
1.3.6.1.2.1.33.5.2.4	bacsNumModules
1.3.6.1.2.1.33.5.2.5	bacsModuleTable
1.3.6.1.2.1.33.5.2.5.1	bacsModuleEntry

1.3.6.1.2.1.33.5.2.5.1.1	bacsModuleIndex
1.3.6.1.2.1.33.5.2.5.1.2	bacsModuleVoltage
1.3.6.1.2.1.33.5.2.5.1.3	bacsModuleTemperature
1.3.6.1.2.1.33.5.2.5.1.4	bacsModuleBypass
1.3.6.1.2.1.33.5.2.5.1.5	bacsModuleResistance
1.3.6.1.2.1.33.5.2.5.1.6	bacsModuleState
1.3.6.1.2.1.33.5.2.6	bacsNumStrings2
1.3.6.1.2.1.33.5.2.7	bacsStringTable
1.3.6.1.2.1.33.5.2.7.1	bacsStringEntry
1.3.6.1.2.1.33.5.2.7.1.1	bacsStringIndex
1.3.6.1.2.1.33.5.2.7.1.2	bacsStringCurrent
1.3.6.1.2.1.33.5.2.7.1.3	bacsStringTotalVolt
1.3.6.1.2.1.33.5.2.7.1.4	bacsStringAverageVolt
1.3.6.1.2.1.33.5.2.7.1.5	bacsStringCurrentAC 1
1.3.6.1.2.1.33.5.2.7.1.6	bacsStringAlarm
1.3.6.1.2.1.33.5.2.7.1.7	bacsStringAlarm2
1.3.6.1.2.1.33.5.3	bacsAlarms
1.3.6.1.2.1.33.5.3.1	bacsAlarmsPresent
1.3.6.1.2.1.33.5.3.2	bacsAlarmTable
1.3.6.1.2.1.33.5.3.2.1	bacsAlarmEntry
1.3.6.1.2.1.33.5.3.2.1.1	bacsAlarmId
1.3.6.1.2.1.33.5.3.2.1.2	bacsAlarmDescr
1.3.6.1.2.1.33.5.3.2.1.3	bacsAlarmTime
1.3.6.1.2.1.33.5.3.3	bacsWellKnownAlarms
1.3.6.1.2.1.33.5.3.3.1	bacsAlarmSystemError
1.3.6.1.2.1.33.5.3.3.2	bacsAlarmResistWarn
1.3.6.1.2.1.33.5.3.3.3	bacsAlarmResistAlarm
1.3.6.1.2.1.33.5.3.3.4	bacsAlarmVoltage
1.3.6.1.2.1.33.5.3.3.5	bacsAlarmTemperature
1.3.6.1.2.1.33.5.3.3.6	bacsAlarmVoltageHigh
1.3.6.1.2.1.33.5.3.3.7	bacsAlarmVoltageLow
1.3.6.1.2.1.33.5.3.3.8	bacsAlarmTemperatureHigh
1.3.6.1.2.1.33.5.3.3.9	bacsAlarmTemperatureLow
1.3.6.1.2.1.33.5.3.3.10	bacsAlarmResistAlarmHigh
1.3.6.1.2.1.33.5.3.3.11	bacsAlarmResistAlarmLow
1.3.6.1.2.1.33.5.3.3.12	bacsAlarmEqualizing
1.3.6.1.2.1.33.5.3.3.13	bacsAlarmVoltageWarnHigh
1.3.6.1.2.1.33.5.3.3.14	bacsAlarmVoltageWarnLow
1.3.6.1.2.1.33.5.3.3.15	bacsAlarmTemperatureWarnHigh
1.3.6.1.2.1.33.5.3.3.16	bacsAlarmTemperatureWarnLow
1.3.6.1.2.1.33.5.3.3.17	bacsAlarmResistWarnHigh
1.3.6.1.2.1.33.5.3.3.18	bacsAlarmResistWarnLow
1.3.6.1.2.1.33.5.3.3.19	bacsAlarmInitializing
1.3.6.1.2.1.33.5.3.3.20	bacsAlarmCommunicationLost
1.3.6.1.2.1.33.5.3.3.21	bacsAlarmBatteryBreakerOpen
1.3.6.1.2.1.33.5.3.3.22	bacsAlarmThermalRunaway
1.3.6.1.2.1.33.5.3.3.23	bacsAlarmSensorCommunicationLost
1.3.6.1.2.1.33.5.3.3.24	bacsAlarmDischarging
1.3.6.1.2.1.33.5.3.3.25	bacsAlarmDischargingStopped
1.3.6.1.2.1.33.5.3.3.26	bacsAlarmMaxVoltageDiff
1.3.6.1.2.1.33.5.3.3.27	bacsAlarmStringVoltHigh
1.3.6.1.2.1.33.5.3.3.28	bacsAlarmStringVoltLow
1.3.6.1.2.1.33.5.3.3.29	bacsAlarmStringVoltHighWarn

1.3.6.1.2.1.33.5.3.3.30	bacsAlarmStringVoltLowWarn
1.3.6.1.2.1.33.5.3.3.31	bacsAlarmStringCurrentHigh
1.3.6.1.2.1.33.5.3.3.32	bacsAlarmStringCurrentLow
1.3.6.1.2.1.33.5.3.3.33	bacsAlarmStringCurrentHighWarn
1.3.6.1.2.1.33.5.3.3.34	bacsAlarmStringCurrentLowWarn
1.3.6.1.2.1.33.5.3.3.35	bacsAlarmStringEqualizingDisabled
1.3.6.1.2.1.33.5.3.3.36	bacsAlarmStringCurrDeviationCharge
1.3.6.1.2.1.33.5.3.3.37	bacsAlarmStringCurrDeviationDischarge
1.3.6.1.2.1.33.5.3.3.38	bacsAlarmStringCurrDeviationChargeWarn
1.3.6.1.2.1.33.5.3.3.39	bacsAlarmStringCurrDeviationDischargeWarn
1.3.6.1.2.1.33.5.3.4	bacsModuleAlarmsPresent
1.3.6.1.2.1.33.5.3.5	bacsModuleWarningsPresent
1.3.6.1.2.1.33.5.4	bacsTraps
1.3.6.1.2.1.33.5.4.1	bacsTrapAlarmEntryAdded
1.3.6.1.2.1.33.5.4.2	bacsTrapAlarmEntryRemoved 2
1.3.6.1.2.1.33.5.5	gxRAUX
1.3.6.1.2.1.33.5.5.1	gxRAUXCount
1.3.6.1.2.1.33.5.5.2	rauxTable
1.3.6.1.2.1.33.5.5.2.1	rauxEntry
1.3.6.1.2.1.33.5.5.2.1.1	rauxIndex
1.3.6.1.2.1.33.5.5.2.1.2	rauxInput1
1.3.6.1.2.1.33.5.5.2.1.3	rauxInName1
1.3.6.1.2.1.33.5.5.2.1.4	rauxInput2
1.3.6.1.2.1.33.5.5.2.1.5	rauxInName2
1.3.6.1.2.1.33.5.5.2.1.6	rauxInput3
1.3.6.1.2.1.33.5.5.2.1.7	rauxInName3
1.3.6.1.2.1.33.5.5.2.1.8	rauxInput4
1.3.6.1.2.1.33.5.5.2.1.9	rauxInName4
1.3.6.1.2.1.33.5.5.2.1.10	rauxOutput1
1.3.6.1.2.1.33.5.5.2.1.11	rauxOutName1
1.3.6.1.2.1.33.5.5.2.1.12	rauxOutput2
1.3.6.1.2.1.33.5.5.2.1.13	rauxOutName2
1.3.6.1.2.1.33.5.5.2.1.14	rauxOutput3
1.3.6.1.2.1.33.5.5.2.1.15	rauxOutName3
1.3.6.1.2.1.33.5.5.2.1.16	rauxOutput
4 1.3.6.1.2.1.33.5.5.2.1.17	rauxOutName4

*OID 1.3.6.1.2.1.33.5.2.1 - bacsStatus Definition table:			
Alarm Description	hex	decimal	BIN
BACS_STATE_NONE	0x0000	0	0000 0000 0000 0000
BACS_STATE_RUNNING	0x0001	1	0000 0000 0000 0001
BACS_STATE_CONNECTED	0x0002	2	0000 0000 0000 0010
BACS_STATE_MODULE_LOST	0x0004	4	0000 0000 0000 0100
BACS_STATE_DISCHARGING	0x0008	8	0000 0000 0000 1000
BACS_STATE_CHARGING	0x0010	16	0000 0000 0001 0000
BACS_STATE_DISCHARGING_STOPPED	0x0020	32	0000 0000 0010 0000
BACS_STATE_FLOAT_CHARGING	0x0040	64	0000 0000 0100 0000
BACS_STATE_EQUALISATION	0x0080	128	0000 0000 1000 0000
BACS_STATE_SYSTEM_FAILURE	0x0100	256	0000 0001 0000 0000
BACS_STATE_VOLTAGE_OUTOFRANGE	0x0200	512	0000 0010 0000 0000
BACS_STATE_TEMPERATURE_OUTOFRANGE	0x0400	1024	0000 0100 0000 0000
BACS_STATE_RESISTOR-OUTOFRANGE	0x0800	2048	0000 1000 0000 0000
BACS_STATE_MODULE-ADDRESSING	0x1000	4096	0001 0000 0000 0000
BACS_STATE_MODULE-SEARCHING	0x2000	8192	0010 0000 0000 0000
BACS_STATE_MODULE-INITIALIZING	0x4000	16384	0100 0000 0000 0000
BACS_STATE_MODULE-POLLING	0x8000	32768	1000 0000 0000 0000
BACS_STATE-GENERAL-ALARM	0x10000	65536	1000 0000 0000 0000 0
BACS_STATE-VOLTAGE-DIFF-HIGH	0x20000	131072	1000 0000 0000 0000 00
BACS_STATE-BATTERY-BREAKER-OPEN	0x40000	262144	1000 0000 0000 0000 000
BACS_STATE_THERMAL_RUNAWAY	0x80000	524288	1000 0000 0000 0000 0000

Copyright and licenses

The copyright authorization from Generex and other relevant software suppliers must be respected. Generex and their suppliers reserve the rights to the software components.

In particular the following are prohibited:

- *copying and distribution,*
- *modifications and derivations,*
- *decompilation, reverse engineering,*

Components which fall under GNU General Public License and further Open Source licenses are integrated into the software. An overview of the integrated Open Source components and a copy of the current license can be obtained at www.generex.de/legal/sla.

Generex will provide the source code for all components of software licensed under the GNU General Public License and comparable Open Source licenses.

For source code requests, please email info@generex.de.